

Features

- Bask® heated surface creates spa-like relaxation with soothing warmth on your back, shoulders, and neck
- Customize the heat with three adjustable settings
- Integral lumbar support
- Slotted overflow allows for deep soaking
- Integral flange helps prevent water from seeping behind wall and simplifies alcove installation

Material

- Acrylic

Installation

- Right drain
- Undermount
- Alcove
- Requires 110 V electrical service

Required Products/Accessories

K-7271 Brass Slotted Overflow Bath Drain

or

K-7272 PVC Slotted Overflow Bath Drain

Recommended Products/Accessories

K-1491 Bath/Whirlpool Pillow

K-1601 Bath/whirlpool footstop, removable

K-23726 Drain treatment

ADA

Codes/Standards

CSA B45.5/IAPMO Z124

ASTM E162

ASTM E662

ADA

ICC/ANSI A117.1

cUL Listed





UL Listed

**KOHLER® Plastic Baths and
Shower Bases Lifetime Limited
Warranty KOHLER® Hydrotherapy
Components Five-Year Limited
Warranty**

See website for detailed warranty information.

Available Colors/Finishes

Color tiles intended for reference only.

Color	Code	Description
	0	White
	96	Biscuit
	95	Ice™ Grey
	7	Black Black™

No change in measurement if connected with drain illustrated. (K-7272)

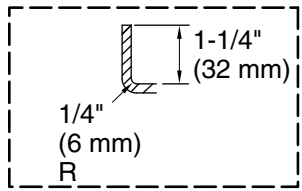

Integral Flange Detail

Access Panel
 20" (508 mm) L x 15" (381 mm) H Min

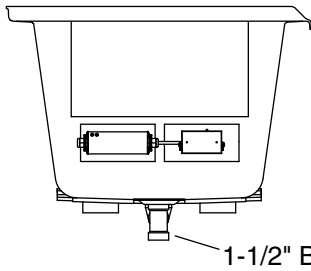

Heater pad is located on this side

1-1/2" Bath Drain

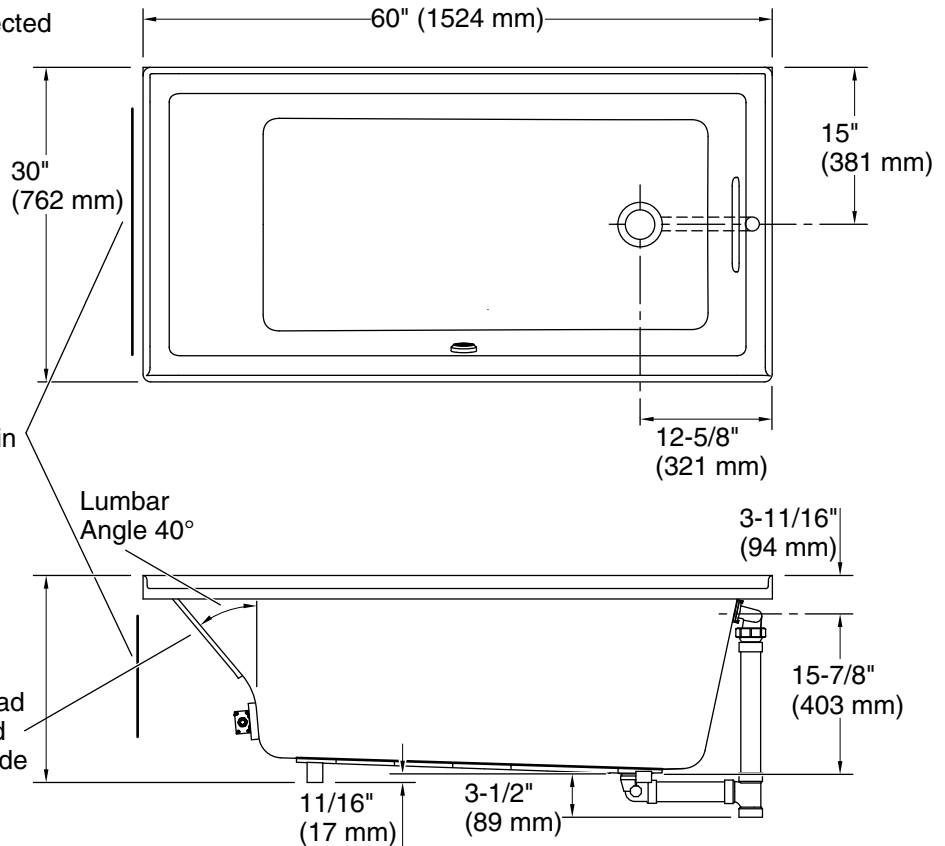

Required Electrical Service

One circuit required, protected with Class A Ground-Fault Circuit-Interrupter (GFCI). Outside North America, this device may be known as a Residual Current Device (RCD).

Heated Surface: 120 V, 15 A

Technical Information

All product dimensions are nominal.

- Drain location: Right
- Basin area, bottom: 42-7/16" x 20" (1078 mm x 508 mm)
- Basin area, top: 54-5/16" x 24-1/4" (1380 mm x 616 mm)
- Weight: 81 lbs (36.7 kg)
- Minimum floor load: 42 lbs/ft² (205.1 kg/m²)
- Water depth: 15-1/8" (384 mm)
- Water capacity: 59.8 gal (226.4 L)
- Electrical component rating: Heated Surface: 120 V, 0.5 A, 60 Hz
- Minimum flat for door: 1-15/16" (49 mm)

Notes

- Measure your actual product for rough-in details.
- Install this product according to the installation instructions.
- The hot water supply should be 70% of the capacity of the bath or greater. Installations will vary.
- ADA compliant when installed to the specific requirements of these regulations.