

ASSEMBLY INSTRUCTIONS

COFFEE TABLE

A Top Panel

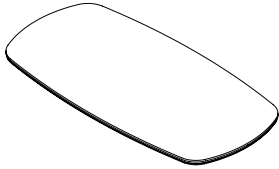

1PC

B Column Base

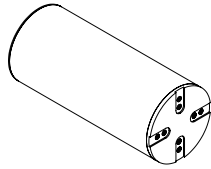

4PCS

C Metal Bracket
80 x 25 x 3mm

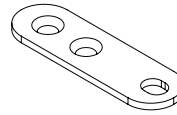

16PCS

D Bolt
Ø1/4" x 1/2" x Ø11mm

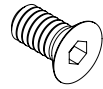

32PCS

E Bolt
Ø1/4" x 5/8" x Ø13mm



16PCS

F Allen Key
M4

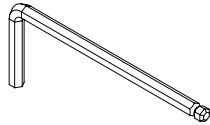

1PC

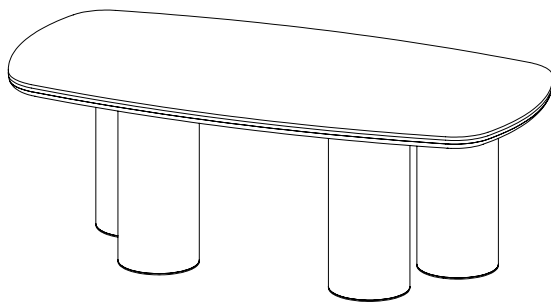

This page lists all the contents included in the box. Please take the time to identify the hardware as well as the individual components to this product. As you unpack and prepare for assembly, place the contents on a carpeted or padded area to protect them from damage.

- 1** Attach the Metal Bracket (C) to the Column Base (B) using Bolt (D) with the Allen Key (F).

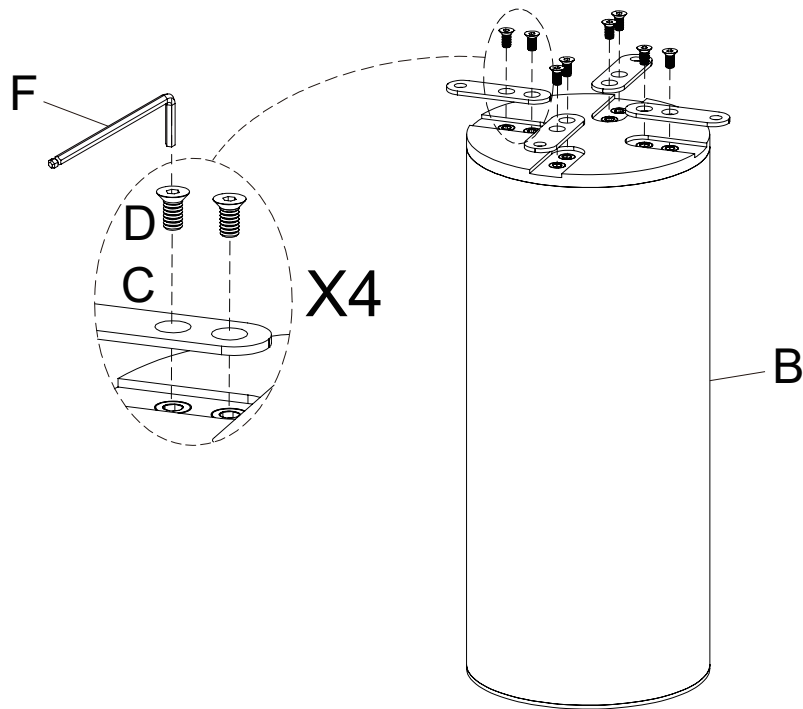

- 2** Attach the Column Base (B) to the Top Panel (A) using Bolt (E) through the Metal Bracket (C) with the Allen Key (F).

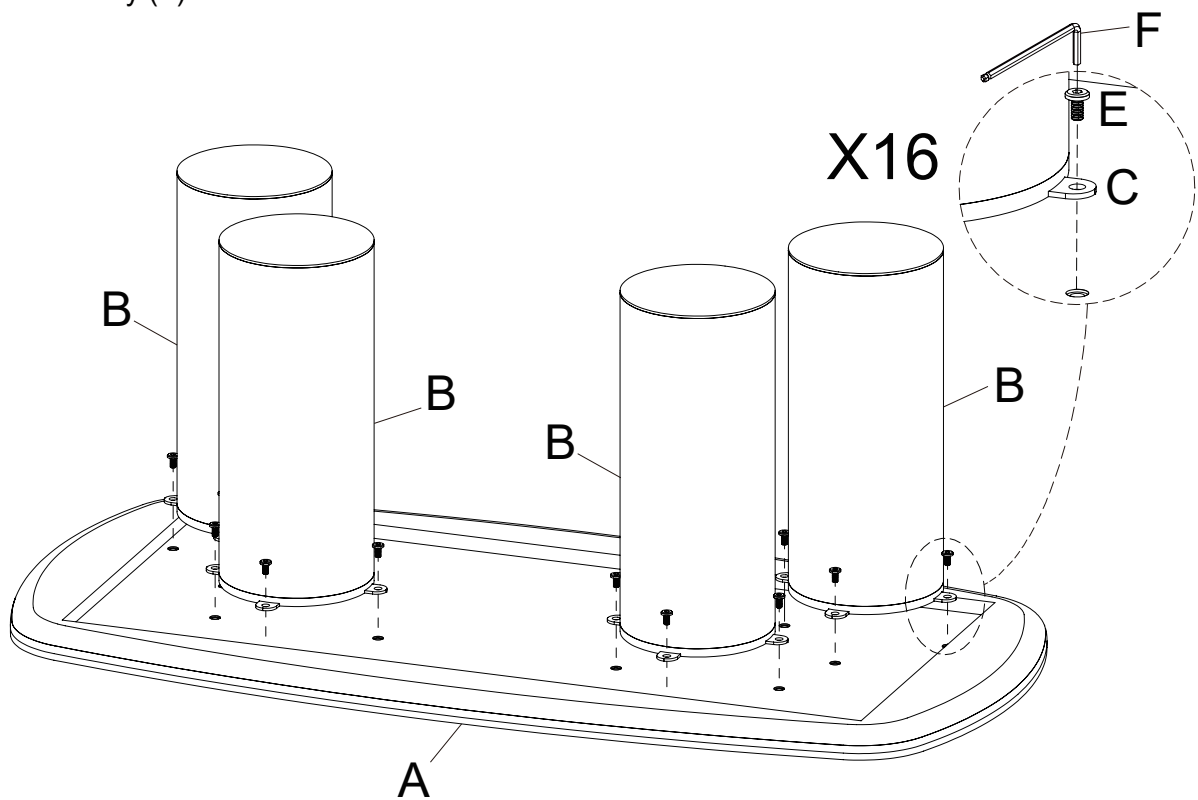

Cleaning & Care

Treat surfaces with care. Surfaces are resistant to scratches but are not scratch resistant. Clean surfaces with a dry or damp soft cloth. Do not use abrasive cleaners. Hardware may loosen over time. Periodically check that all connections are tight.