

8 7 6 5 4 3 2 1

D

C

B

A



D

C

B

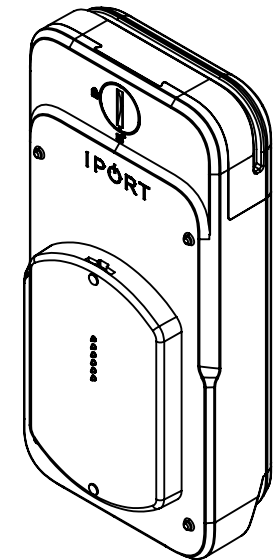
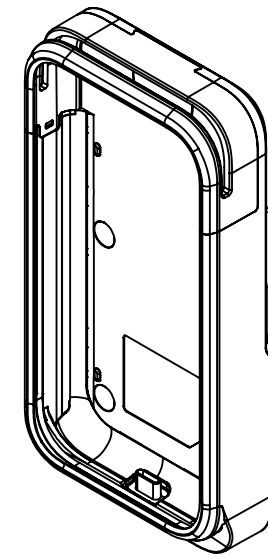
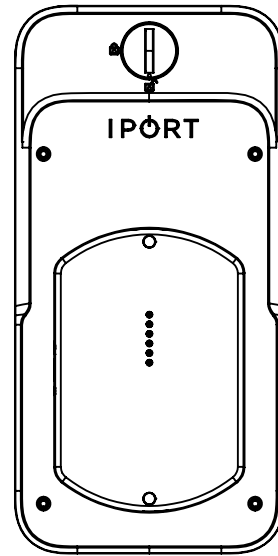
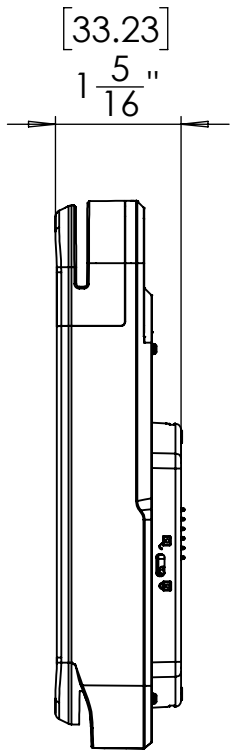
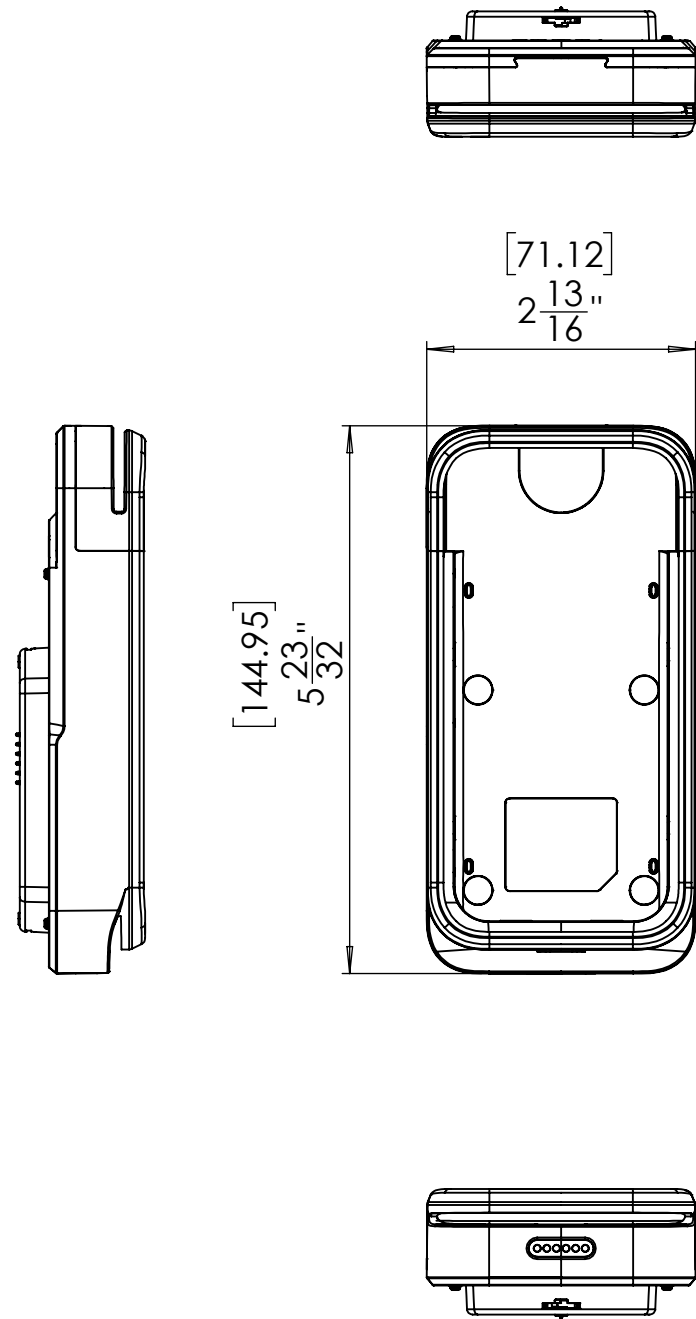
A



  		DANA INNOVATIONS	
TITLE: 72374 CONNECT PRO PAYCASE E285 V2			
SIZE B	DWG. NO.	REV A	
SCALE: 1:2	WT:	SHEET 1 OF 1	

8 7 6 5 4 3 2 1