

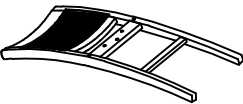

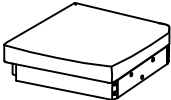

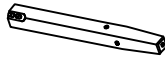



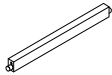
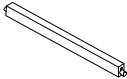
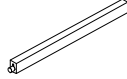
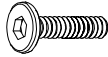
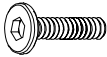

ASSEMBLY INSTRUCTION

RATTAN X-BACK COUNTER HEIGHT CHAIR RATTAN SLAT BACK COUNTER HEIGHT CHAIR

A Chair Back  1 pc	B Seat  1 pc	C Left Front Leg  1 pc	D Right Front Leg  1 pc
E Front Stretcher  1 pc	F Left Stretcher  1 pc	G Right Stretcher  1 pc	H Bolt 1/4" x 3-1/4"  4 pcs
I Bolt 1/4" x 1-1/2"  3 pcs	J Lock Washer 1/4"  7 pcs	K Flat Washer 1/4" x 19mm  7 pcs	L Flat Washer 5/16" x 22mm  4 pcs
M Lock Washer 5/16"  4 pcs	N Hex Nut 5/16" x 12mm  4 pcs	O Screw #8 x 45mm  6 pcs	P Allen Wrench M4  1 pc
Q Spanner 12mm  1 pc			

This page lists all the contents included in the box. Please take the time to identify the hardware as well as the individual components to this product. As you unpack and prepare for assembly, place the contents on a carpeted or padded area to protect them from damage.

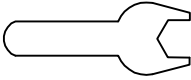
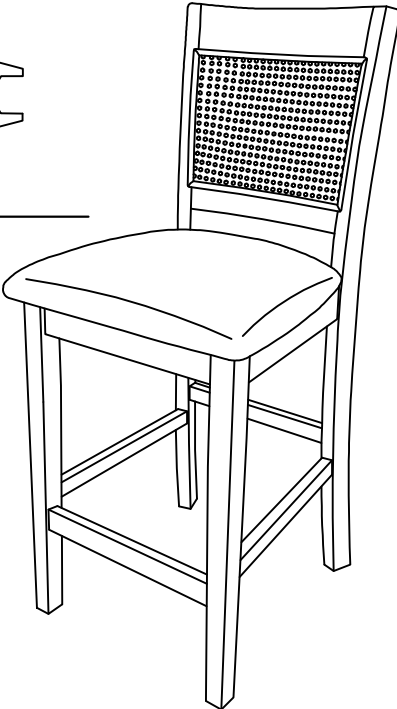
- 1** Place the Seat (B) upside down on a smooth carpeted surface. Put the Front Stretcher (E) between the Left & Right Front Leg (C&D). Attach the Left & Right Front Leg (C&D) to the Seat (B) using Flat Washer (L), Lock Washer (M) and Hex Nut (N) with Spanner (Q).

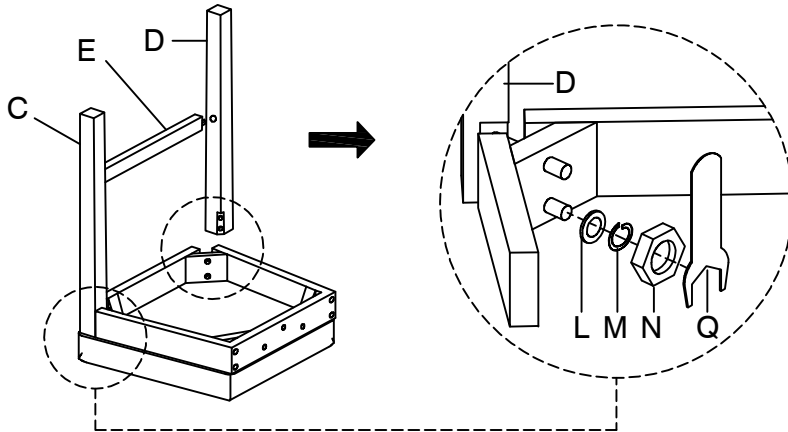

Take the spanner, and turn the washers to the corner blocks until the legs are secured. **DO NOT TIGHTEN COMPLETELY.** Stop when you feel you are adding force to tighten the washer.

- 2** Place the Chair Back (A) on a smooth carpeted surface. Attach the Seat (B) to Chair Back (A) using Bolt (H), Lock Washer (J) and Flat Washer (K) with Allen Wrench (P) at the corners, then tighten Bolt (I), Lock Washer (J) and Flat Washer (K) with Allen Wrench (P). At the same time, attach Left & Right Stretcher (F&G) to the Left & Right Front Leg (C&D) and Chair Back (A).

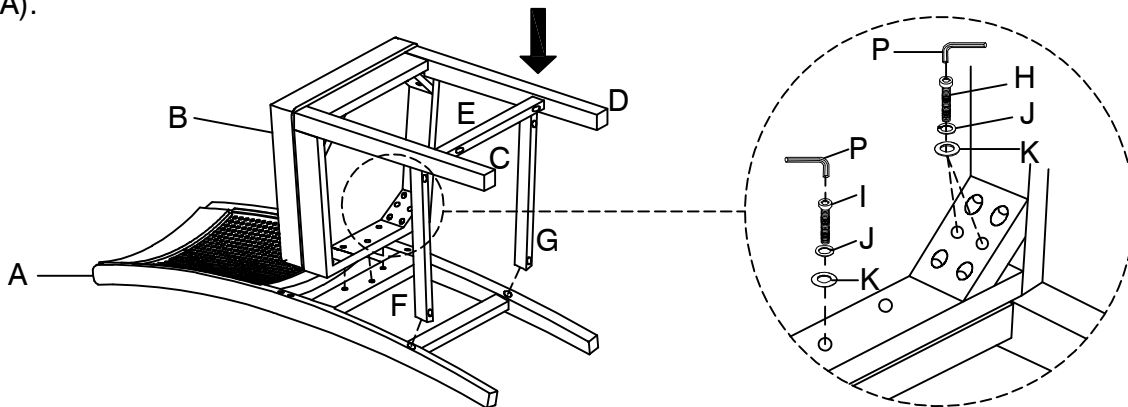

- 3** Tighten the Stretcher (E,F,G) to the Left & Right Front Leg (C&D) and Chair Back (A) using Screw (O) with a Phillips Head Screwdriver (not provided).

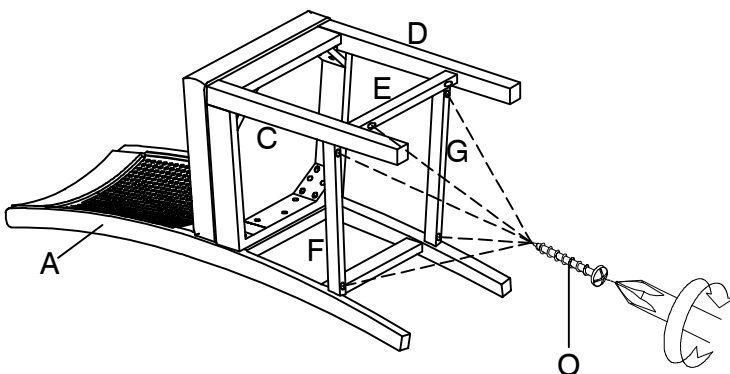

Stand the chair up on an even surface and check that it is balanced. If there is a slight wobble, apply downward pressure in the corner where a leg is uneven. Keeping pressure in that corner, tighten all bolts. If balanced, apply downward pressure evenly in the center and tighten all bolts. Do not over-tighten beyond hole depth.

Helpful Tip: -Instead of applying downward pressure while reaching under to tighten bolts, have someone sit in the chair while you tighten the bolts.

Cleaning & Care

Treat surfaces with care. Surfaces are resistant to scratches but are not scratch resistant. Clean surfaces with a dry or damp soft cloth. Do not use abrasive cleaners. Hardware may loosen over time. Periodically check that all connections are tight.