

ASSEMBLY INSTRUCTION

5-LIGHT CRYSTAL GLASS LED CHANDELIER

A Crossbar

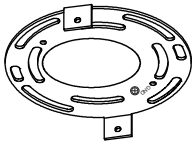

2PCS

B Lamp Body

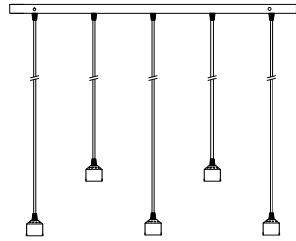

1PC

C Crystal

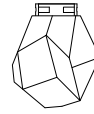

5PCS

D Anchor
Ø6 x 30mm



8PCS

E Cord Buckle
30 x 17mm



5PCS

F Round Head Screw
Ø5/32" x 12mm



10PCS

G Flat Head Screw
Ø5/32" x 19mm



4PCS

H Self-Tapping Screw
Ø4 x 35mm

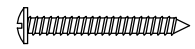

8PCS

I Connector
Ø12 x 22mm

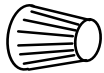

3PCS

J Screwdriver
74 x 32mm

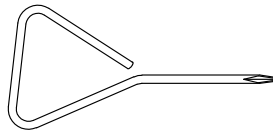

1PC

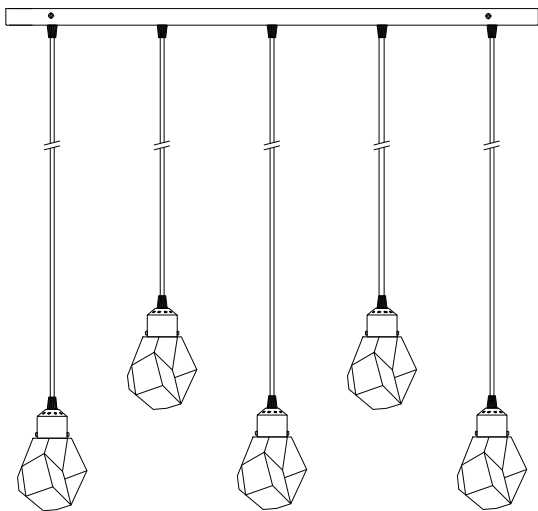

This page lists all the contents included in the box. Please take the time to identify the hardware as well as the individual components to this product. As you unpack and prepare for assembly, place the contents on a carpeted or padded area to protect them from damage.

NOTE: If the fixture does not work properly, contact a licensed electrician.

- 1 Shut off power at the fuse box or circuit breaker box and remove the old fixture including the mounting hardware.

Carefully unpack your new fixture and lay out all the parts in a clear area. Take care not to misplace any small parts necessary for installation.

Use Crossbar (A) as the template and insert Anchor (D) along the junction box. Insert Self-Tapping Screw (H) into Crossbar (A) and Anchor (D) and tighten with screwdriver (not provided). The side of Crossbar (A) marked "GND" must face down. **The junction box is not provided.**

Determine the desired hanging height by loosening and tightening the compression strain relief of Lamp Body (B). Run the cord through Cord Buckle (E). Connect the wires from the fixture and then connect the wires from the junction box to the fixture wires using Connector (I).

- White wire to white (neutral) wire
- Black wire to black (live) wire
- Green ground wire to green ground screw terminal and green ground wire

Tuck these wire connections neatly into the junction box. Then attach Lamp Body (B) to Crossbar (A) using Flat Head Screw (G) with screwdriver (not provided).

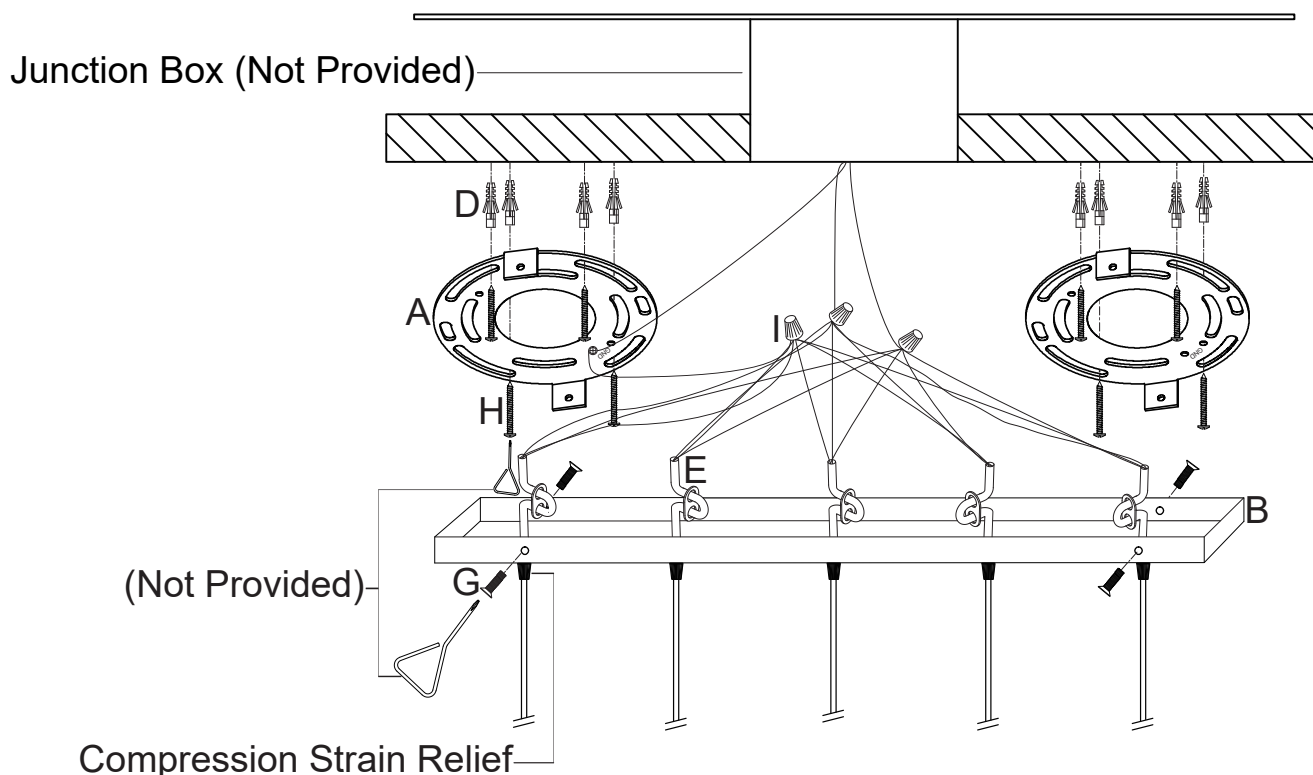

-
- 2** Attach Crystal (C) to Lamp Body (B) using Round Head Screw (F) with Screwdriver (J).

Your installation is now complete. Return power to the junction box and test the fixture.

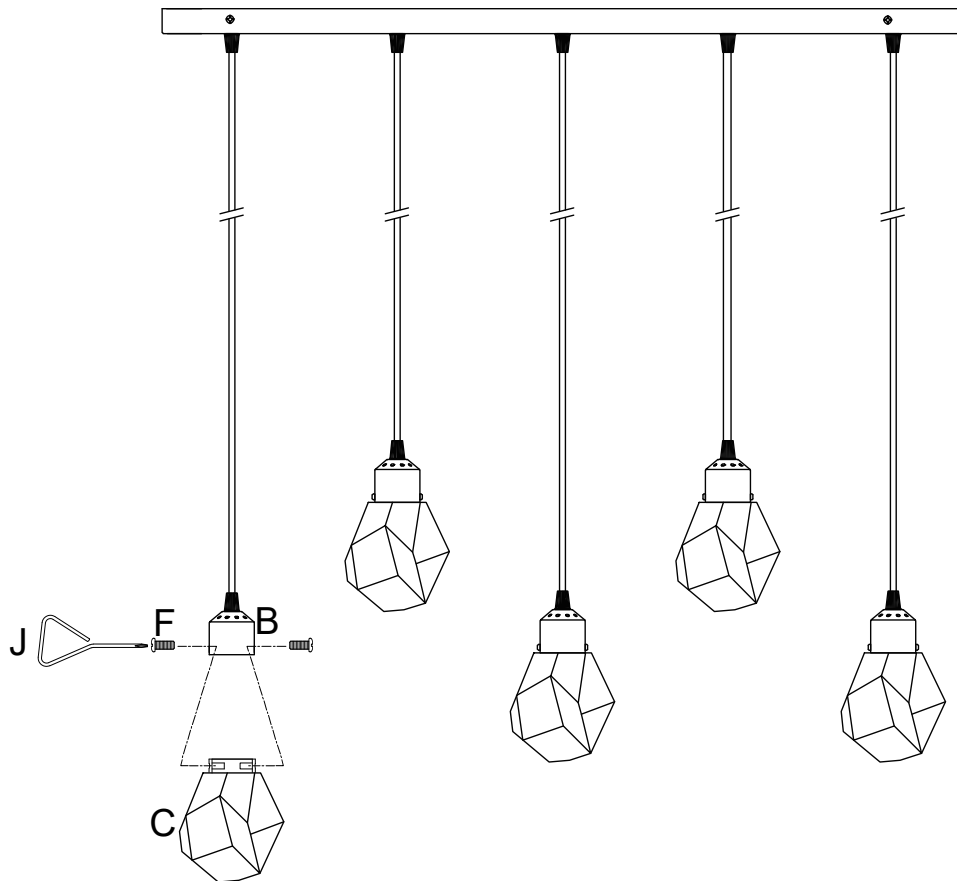

Cleaning & Care

Treat surfaces with care. Surfaces are resistant to scratches but are not scratch resistant. Clean surfaces with a dry or damp soft cloth. Do not use abrasive cleaners. Hardware may loosen over time. Periodically check that all connections are tight.