

SAFETY INFORMATION

Please read and understand this entire manual before attempting to assemble, install or operate the product.

WARNING

- RISK OF ELECTRIC SHOCK - Before beginning installation, turn off electricity at the circuit breaker box or the main fuse box.

CAUTION

- For your safety, read instructions completely before beginning installation.
- If in doubt about electrical installation, consult a licensed electrician.

TOOLS REQUIRED

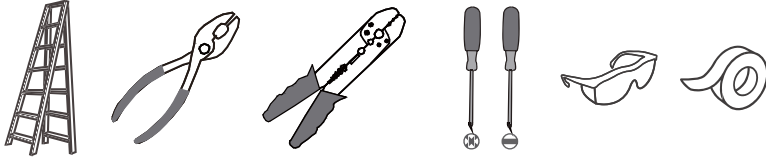

Ratings	120~277Vac, 60Hz	
	Model No.	Wattage
	PCSKY1812BRG	37W

CARE AND MAINTENANCE

- Wipe clean using soft, dry cloth or static duster. Always avoid using harsh chemicals and abrasives to clean fixture as they may damage the finish.

If you need further assistance call Quozel Customer Care at 1-800-645-3184 (9:00am - 5:00pm EST), or visit us on-line at www.quezel.com.

PACKAGE CONTENTS

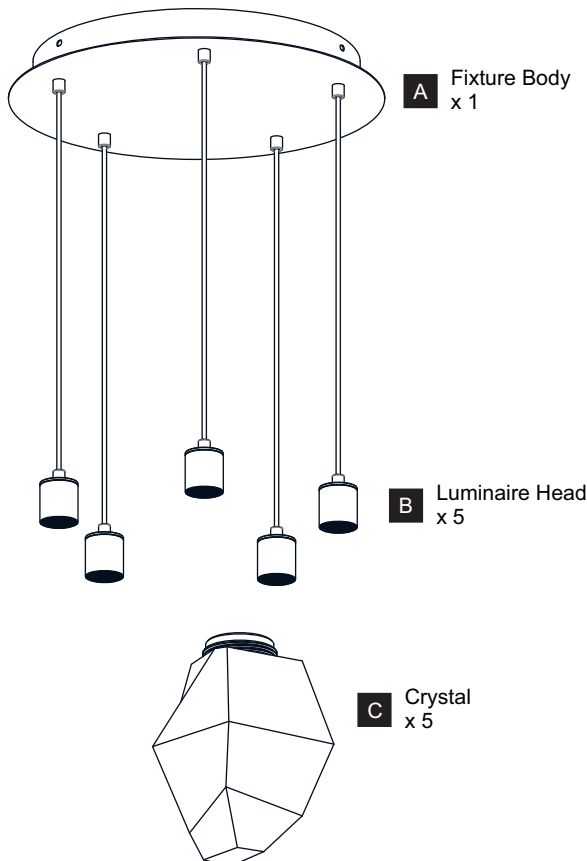

MOUNTING HARDWARE

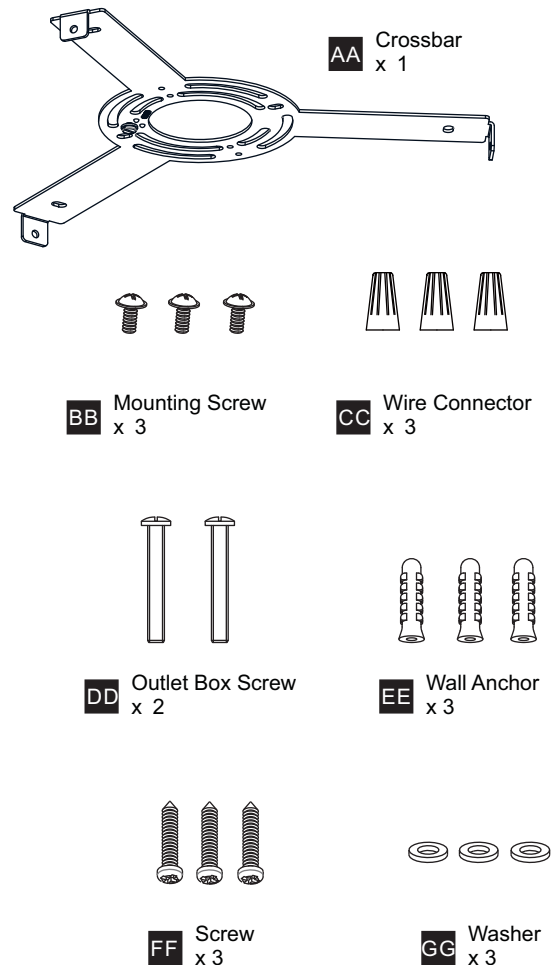

INSTALLATION

1 Adjust Cord Length: Fixture Height Adjustable 13" to 103"

By using screwdriver, loosen the set screw on the cord relief to adjust the cord length. Always tighten the set screw once the desired hanging height is achieved. Repeat this process for each cord.

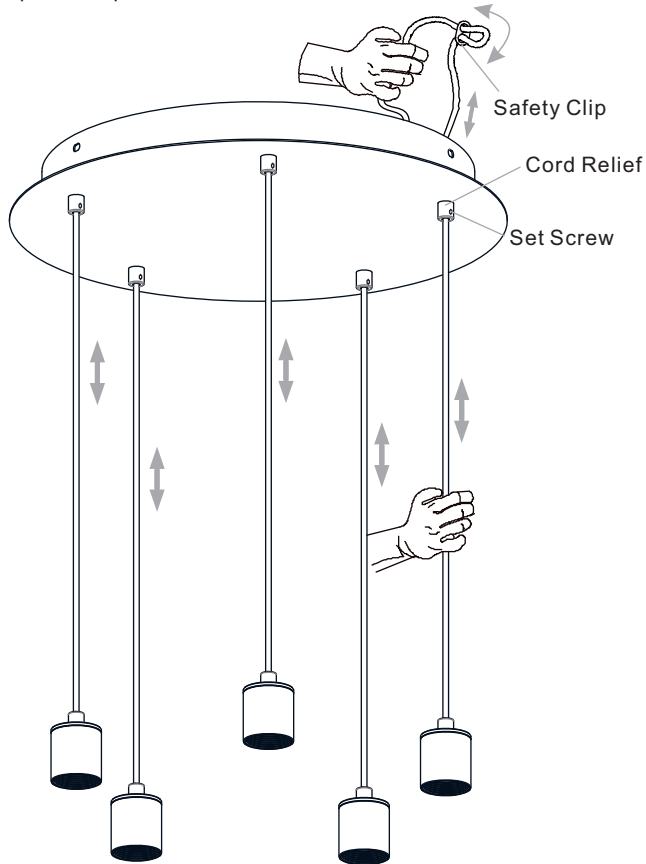

2 Install Crossbar

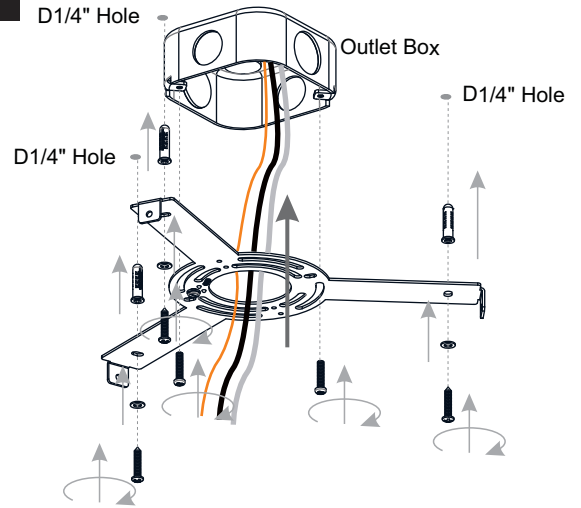

3 Wiring

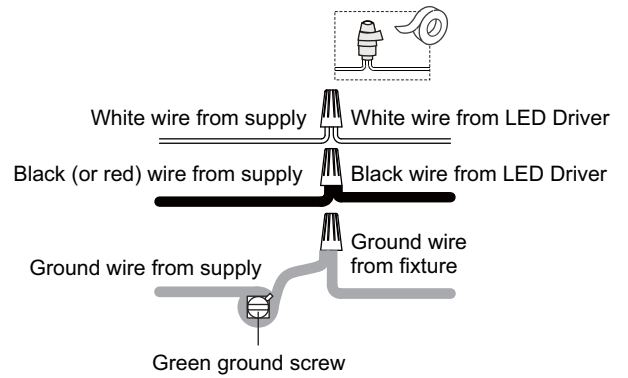

4 Install Ceiling Canopy to Crossbar

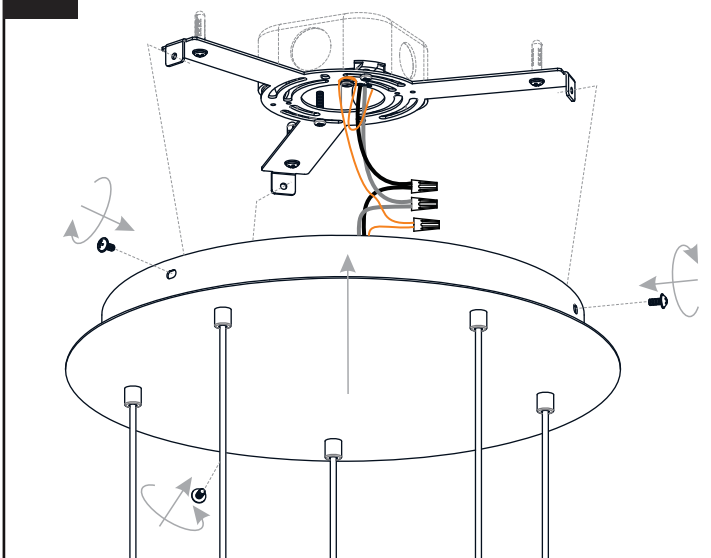

5 Install Crystals

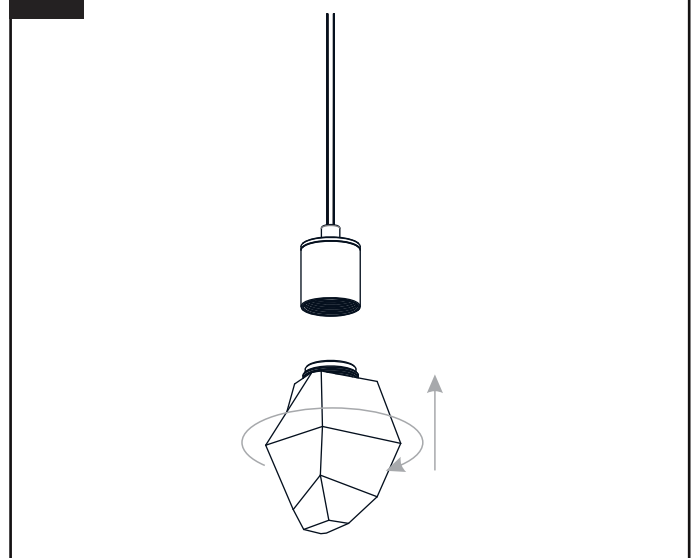

Your installation is now complete! Restore electricity and save this sheet for future reference.