

## Features

- One-piece, self-contained ceramic disc valve allows for both volume and temperature control
- High-temperature limit setting for added safety
- Touch-activated drain with tailpiece and overflow
- 6-1/4" (159 mm) spout reach
- Straight handle
- 1.2 gpm (4.5 lpm) maximum flow rate at 60 psi (4.14 bar)

## Material

- Brass

## Installation

- Single-hole mounting

## Recommended Products/Accessories

- K-23726 Drain treatment
- K-14375 24" Double Towel Bar
- K-14377 Pivoting toilet paper holder
- K-14435 18" Towel Bar
- K-14436 24" Towel Bar
- K-14441 Towel Ring
- K-14443 Robe Hook
- K-14444 Vertical toilet paper holder

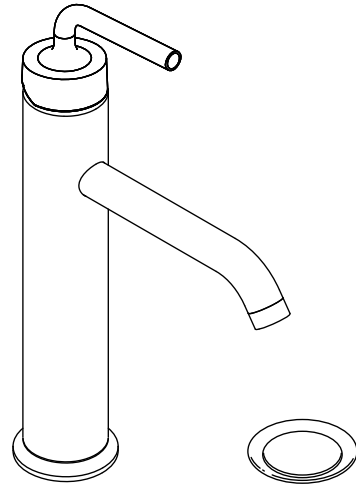

## Codes/Standards









ASME A112.18.1/CSA B125.1  
NSF/ANSI/CAN 61  
NSF/ANSI/CAN 372  
DOE - Energy Policy Act 1992  
EPA WaterSense®  
California Energy Commission (CEC)

## KOHLER® Faucet Lifetime Limited Warranty

See website for detailed warranty information.

## Available Colors/Finishes

*Color tiles intended for reference only.*

Color	Code	Description
	CP	Polished Chrome
	SN	Vibrant® Polished Nickel
	AF	Vibrant® French Gold
	BN	Vibrant® Brushed Nickel
	BV	Vibrant® Brushed Bronze
	BL	Matte Black
	2MB	Vibrant® Brushed Moderne Brass
	BGP	Vibrant Brushed Graphite
	TT	Vibrant Titanium

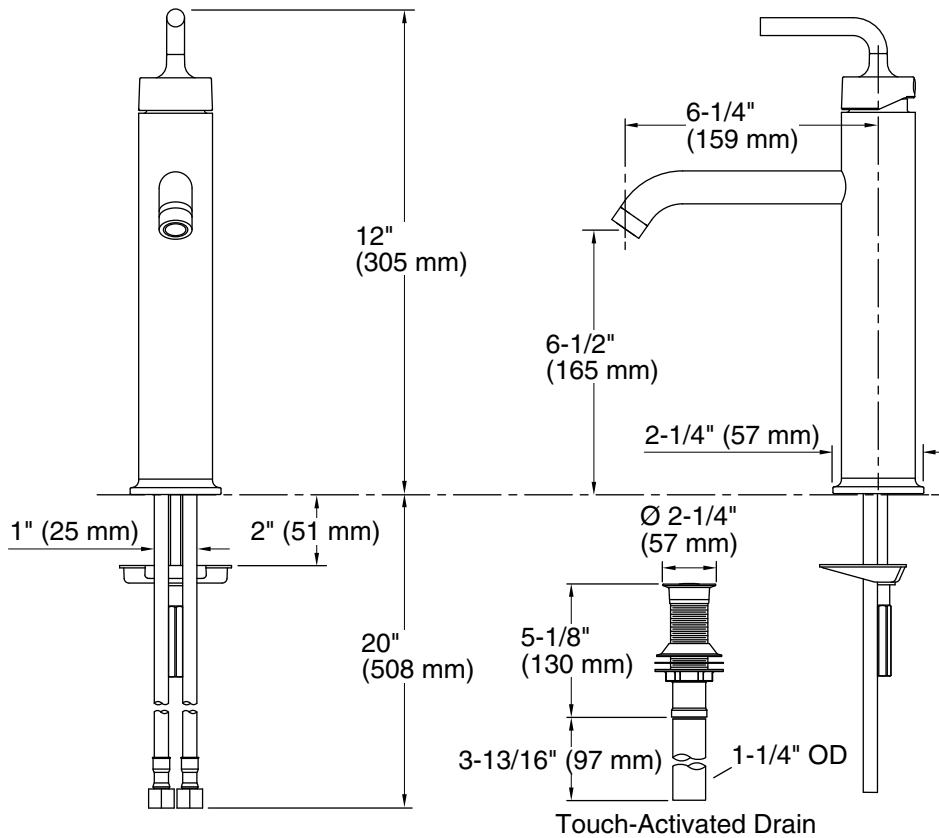

### Technical Information

All product dimensions are nominal.

Faucet flow rate: 1.2 gal/min (4.5 l/min)

Drain included: Yes

Drain with overflow: Yes

Drain tailpiece included: Yes

### Spout:

Spout reach: 6-1/4" (159 mm)

### Notes

Install this product according to the installation instructions.