









HEKMAN[®]

X A HOWARD MILLER COMPANY

79410P / 79430P PEDS & MODESTY PANEL 79410T / 79430T TOP PANEL

HARDWARE LIST					
A	B	C	D	E	F
ALLEN BOLT $\frac{5}{16}$ " x 2" (4 Pcs)	ALLEN BOLT $\frac{5}{16}$ " x 6" (2 Pcs)	FLAT W. M8 (6 Pcs)	LOCK W. M8 (6 Pcs)	ALLEN KEY L5 (FOR BOLT $\frac{5}{16}$ " 1 Pc)	COVER CAPS (4 Pcs)
					

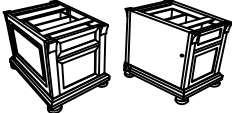
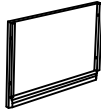

PART INSIDE			
1	2	3	4
TOP ASSEMBLY (1 Pc)	PEDESTALS (2 Pcs)	MODESTY PANEL (1 Pc)	BUN FEET (8 Pcs)
			

Assembly Instruction

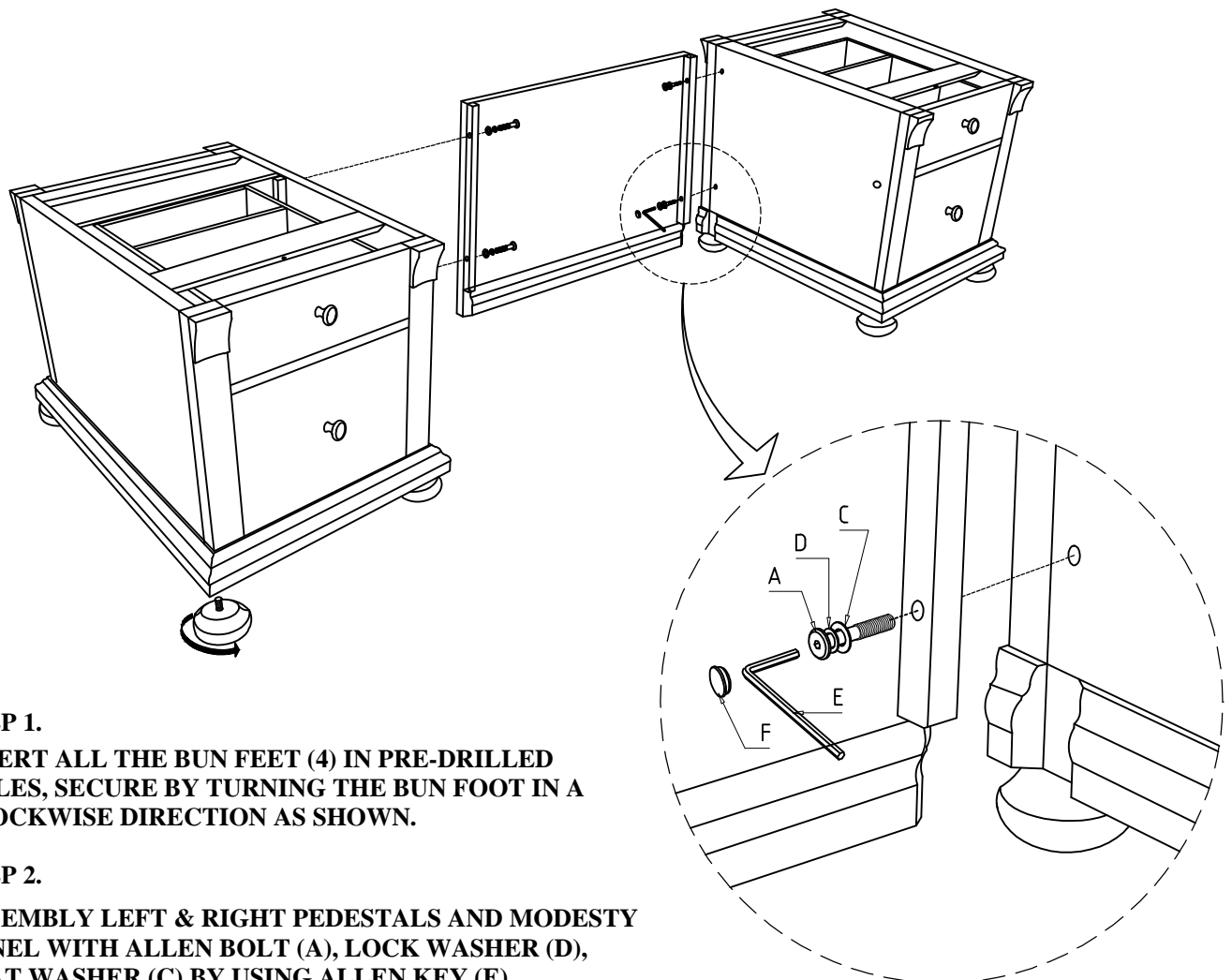

STEP 1.

INSERT ALL THE BUN FEET (4) IN PRE-DRILLED HOLES, SECURE BY TURNING THE BUN FOOT IN A CLOCKWISE DIRECTION AS SHOWN.

STEP 2.

ASSEMBLY LEFT & RIGHT PEDESTALS AND MODESTY PANEL WITH ALLEN BOLT (A), LOCK WASHER (D), FLAT WASHER (C) BY USING ALLEN KEY (E). COVER THE BOLTS WITH COVER CAPS (F).

STEP 3.

PLACE THE TOP ASSEMBLY ON THE PEDESTALS AS SHOWN IN THE SIDE VIEW THE TOP ASSEMBLY IS SET A LITTLE FOWARD ON THE PEDESTALS THAN PUSHED BACK TO LOCK THE FRENCH CLEATS. OPEN THE UPPER DRAWERS IN THE PEDESTALS. SCREW THE TOP PANEL ASSEMBLY AND PEDESTALS WITH ALLEN BOLT (B), LOCK WASHER (D), FLAT WASHER (C) USING ALLEN KEY (E). CLOSE UPPER DRAWERS.

