

# ASSEMBLY INSTRUCTION

## TUFTED SOFA

**A** Seat Frame

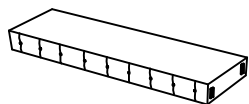

1pc

**B** Back Frame

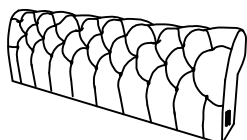

1pc

**C** Left Panel

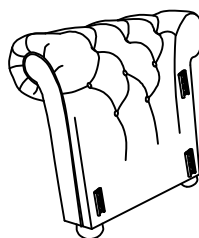

1pc

**D** Right Panel

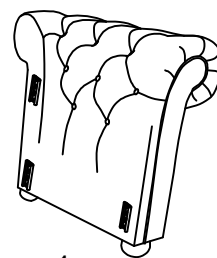

1pc

**E** Seat Cushion

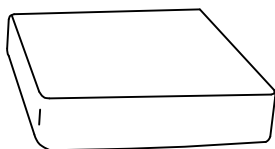

3pcs

**F** Plastic Leg

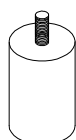

2pcs

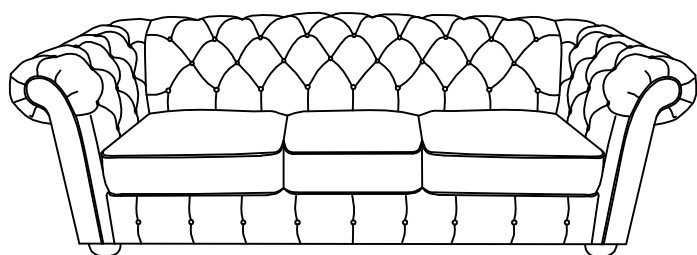

This page lists all the contents included in the box. As you unpack and prepare for assembly, place the contents on a carpeted or padded area to protect them from damage.

**1** Hook on the Left Panel (C) & Right Panel (D) to Seat Frame (A) properly.

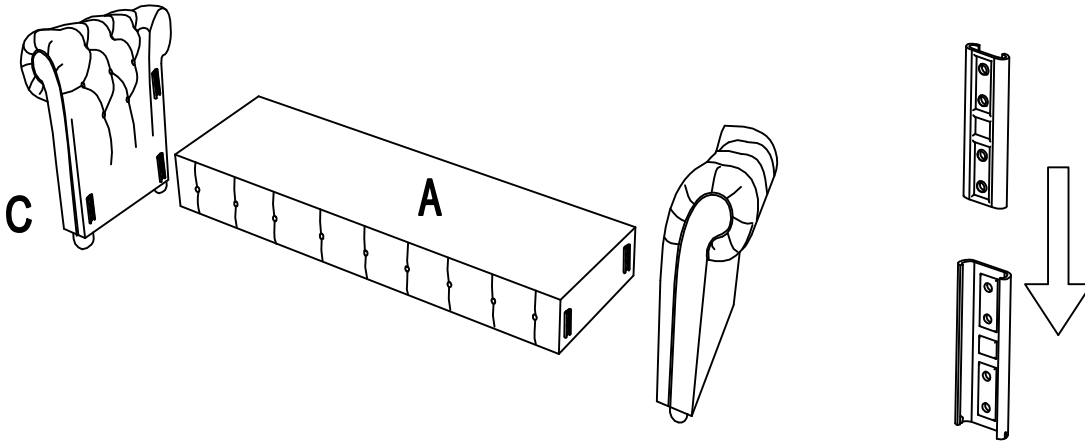

**2** Assembly the Plastic Leg (F) at the bottom of Seat Frame (A) as picture showing.

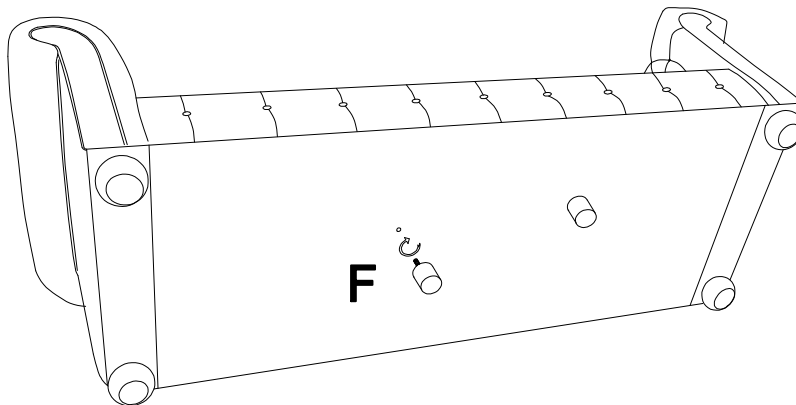

**3** Hook on the Back Frame (B) to Left Panel (C) & Right Panel (D) properly.

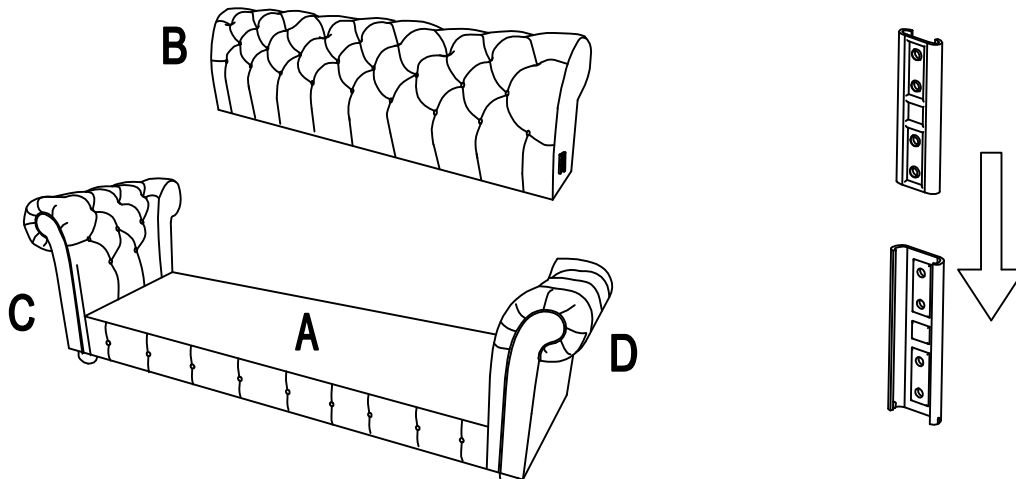

---

**4**

Place Seat Cushion (E) on the chair properly. The assembly is complete.

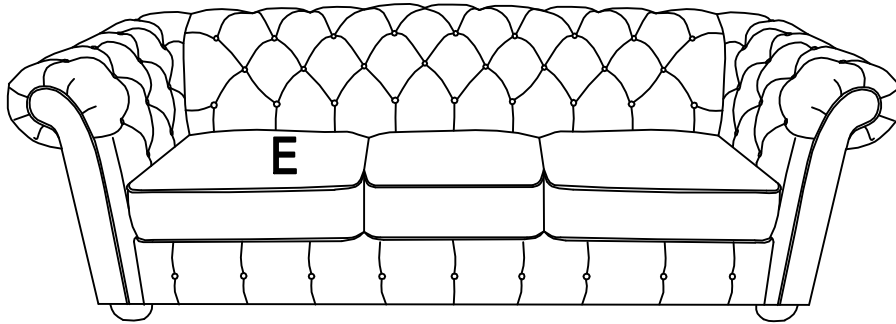

---

### **Cleaning & Care**

Treat surface with care. Surface is resistant to scratches but is not scratch resistant. Clean surfaces with a dry or damp soft cloth. Do not use abrasive cleaners.

# ASSEMBLY INSTRUCTION

## TUFTED CORNER SEAT

**A** Seat Frame

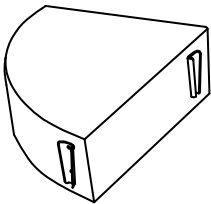

1pc

**B** Back Frame

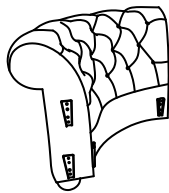

1pc

**C** Seat Cushion

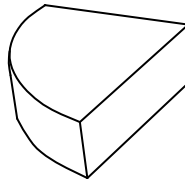

1pc

**D** Wooden Leg

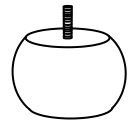

1pc

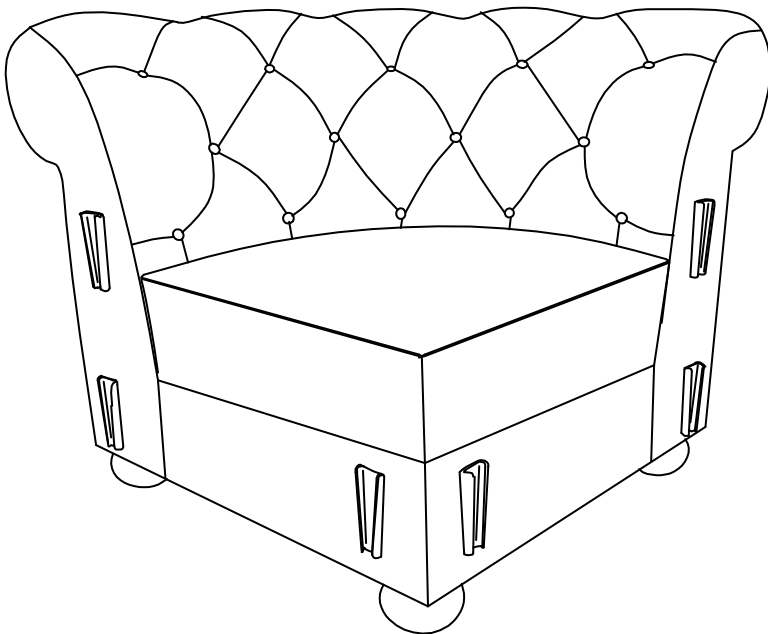

This page lists all the contents included in the box. As you unpack and prepare for assembly, place the contents on a carpeted or padded area to protect them from damage.

**1** Assemble the Wooden Leg (D) to bottom of Seat Frame (A).

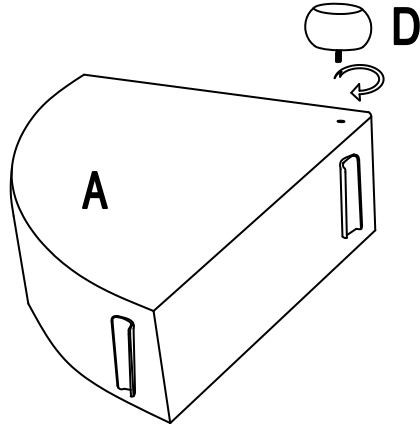

**2** Hook on Seat Frame (A) to Back Frame (B) properly.

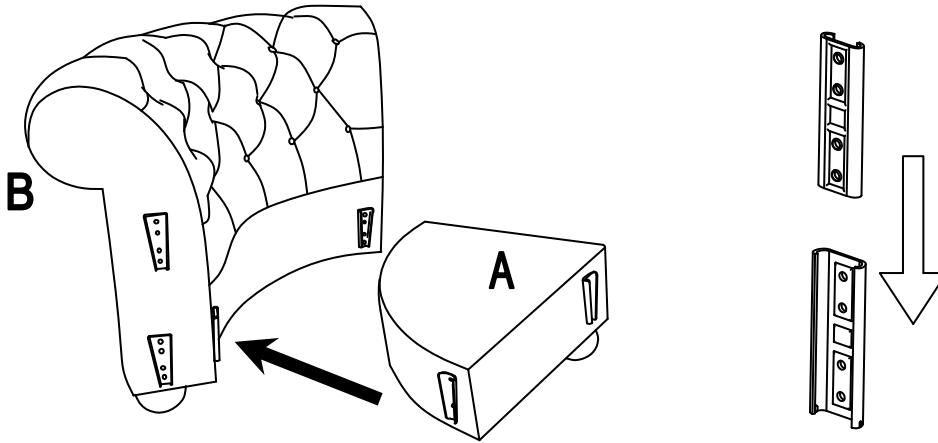

**3** Hook on Seat Frame of Chair, Love Seat or Sofa to Corner Seat (A) and (B) properly. (Seat Frame of Chair, Love Seat or Sofa are not in the Corner Seat carton)

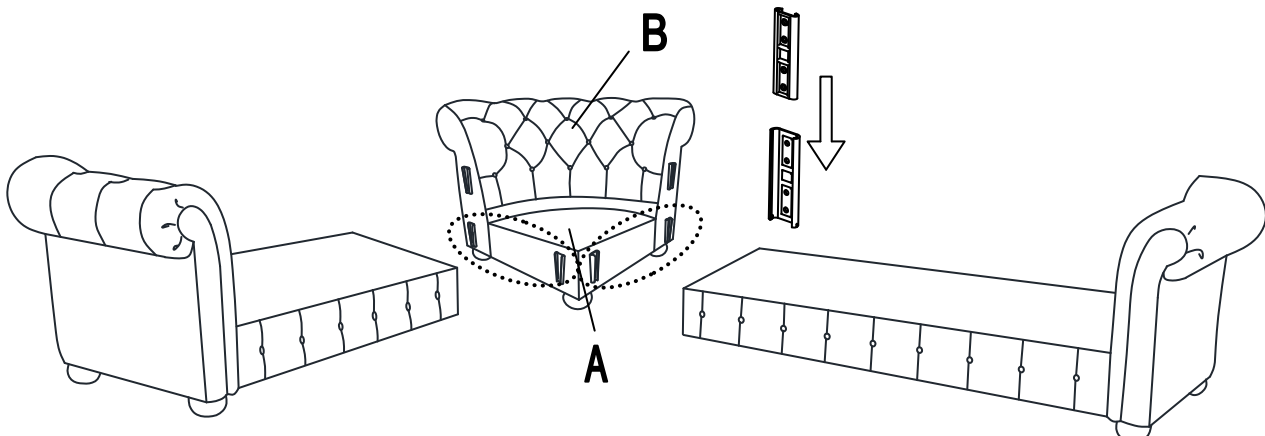

- 
- 4** Hook on Back Frame of Chair, Love Seat or Sofa to Back Frame (B) properly.  
(Back Frame of Chair, Love Seat or Sofa are not in the Corner Seat carton)

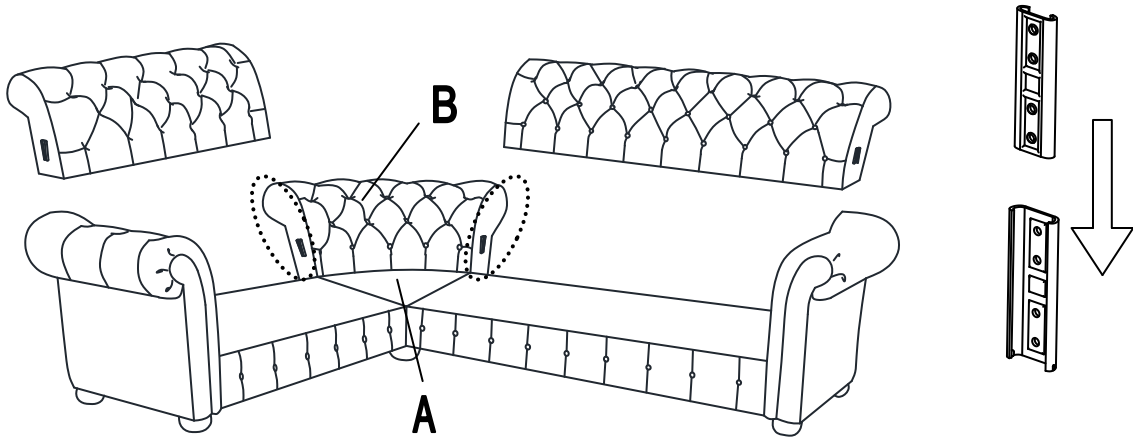

- 
- 5** Put the Corner Cushion (C) and the cushion of Chair, Love Seat or Sofa on Sofa Frame. The assembly is completed.

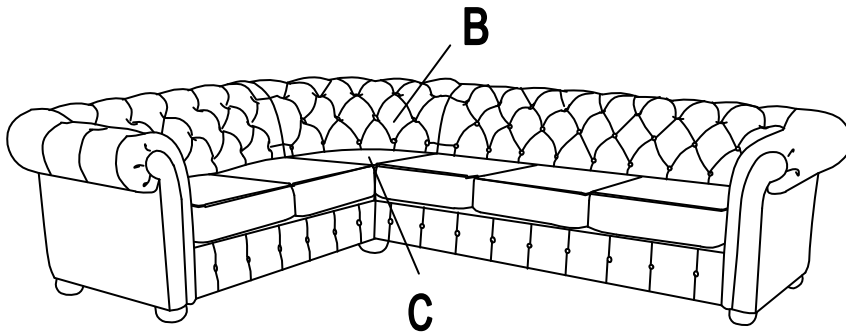

---

### Cleaning & Care

Treat surface with care. Surface is resistant to scratches but is not scratch resistant.  
Clean surfaces with a dry or damp soft cloth. Do not use abrasive cleaners.