

# Beldray<sup>est 1872</sup><sup>®</sup>

**Our smart  
& slimline  
radiator**



**1500 W SMART  
CERAMIC CORE  
RADIATOR**  
INSTRUCTION MANUAL



[www.beldray.com](http://www.beldray.com)

Please retain instructions for future reference.

## **WARNING - READ BEFORE USE**

Never use the product to dry laundry.

Do not leave the product unattended while in use.

Do not use in dusty environments.

Do not use heating appliances with an extension cord.

The product must be used on a stable, heat-resistant surface.

This product can be used for no longer than 4 hours, after which time it must be switched off.

Ensure that the product has at least 1 metre of free space in all directions before use.

Ensure that any flammable materials, such as furniture and curtains, are at least 1 metre away from the product when in use.

## **Safety Instructions**

When using electrical products, basic safety precautions should always be followed.

Check that the voltage indicated on the rating plate corresponds with that of the local network before connecting the product to the mains power supply.

Children aged from 8 years and people with reduced physical, sensory or mental capabilities or lack of experience and knowledge can use this appliance, only if it has been placed in its intended operating position and they have been given supervision or instruction concerning use of the appliance in a safe way and understand the hazards involved.

Children should not perform cleaning or user maintenance unless they are older than 8 years and supervised.

This product is not a toy - children should be supervised to ensure they do not play with the product.

Nominal voltage is still present in this product as long as the product is connected to the electrical source.

If the power supply cord, plug or any part of the appliance is malfunctioning or if it has been dropped or damaged, cease using the product immediately to avoid potential injury.

This appliance contains no user serviceable parts, only a qualified electrician should carry out repairs. Improper repairs may place the user at risk of harm.

Do not allow the power cord to hang over sharp edges or come into contact with hot surfaces.

Do not run the supply cord under carpets, rugs etc. or anywhere where it may present a trip hazard.

Do not immerse the product or plug in water or any other liquid.

Do not operate the product with wet hands.

Do not use this product in the immediate surroundings of a bath, a shower or swimming pool.

Do not remove from the mains power supply by pulling the cord; switch off and remove the plug by hand.

Do not leave the product plugged in or operating overnight.

Do not use the product for anything other than its intended use.

Do not attempt to move the product whilst it is in use.

Do not use the product with a programmer, timer, separate remote-control system or any other device that will switch the product on automatically, as there is a risk of fire if the heater is covered or positioned incorrectly.

Do not use on carpets, rugs or other flammable floor-based textiles. The product must not be located immediately below or next to a mains power supply.

Never use accessories that are not recommended or supplied by the manufacturer. It could cause danger to the user and damage to the product.

This product is intended for domestic use only. It should not be used for commercial purposes.

**CAUTION:** Some parts of this product can become very hot and cause burns. Particular attention has to be given where children

and vulnerable people are present.



Hot surface – do not touch the hot section or heating components of the product.



**WARNING:** In order to avoid overheating, do not cover the product.

This product is not equipped with a device to control the room's temperature.

Do not use this product in small rooms whilst occupied by persons incapable of leaving the room on their own, unless constant supervision is provided.

## Thermal Cut-out Device

The radiator is fitted with a thermal safety cut-out device, built in to prevent it from overheating. Should the radiator start to overheat, the thermal safety cut-out system will automatically operate and the heat settings will switch off. If this happens:

**STEP 1:** Switch off the radiator.

**STEP 2:** Check that the radiator is unplugged from the mains power supply and allow it to cool for approx. 30 minutes.

**STEP 3:** Clear anything that is covering, leaning against or restricting adequate ventilation to the radiator, being careful not to damage the radiator.

**STEP 4:** Plug in and switch on the radiator at the mains power supply.

**CAUTION:** In order to avoid a hazard, due to inadvertent resetting of the thermal cut-out, the radiator must not be supplied through an external switching device such as a timer or connected to a circuit that is regularly switched on and off by the utility.

## Care and Maintenance

Always unplug the radiator from the mains power supply and allow it to cool sufficiently before performing any cleaning or maintenance.

Wipe the exterior of the radiator with a soft, damp cloth and allow

to dry thoroughly.

Do not clean the radiator with abrasive chemicals or materials such as scourers, as this may damage the radiator and impair future function. This includes insecticide and chemical solvents.

### Description of Parts

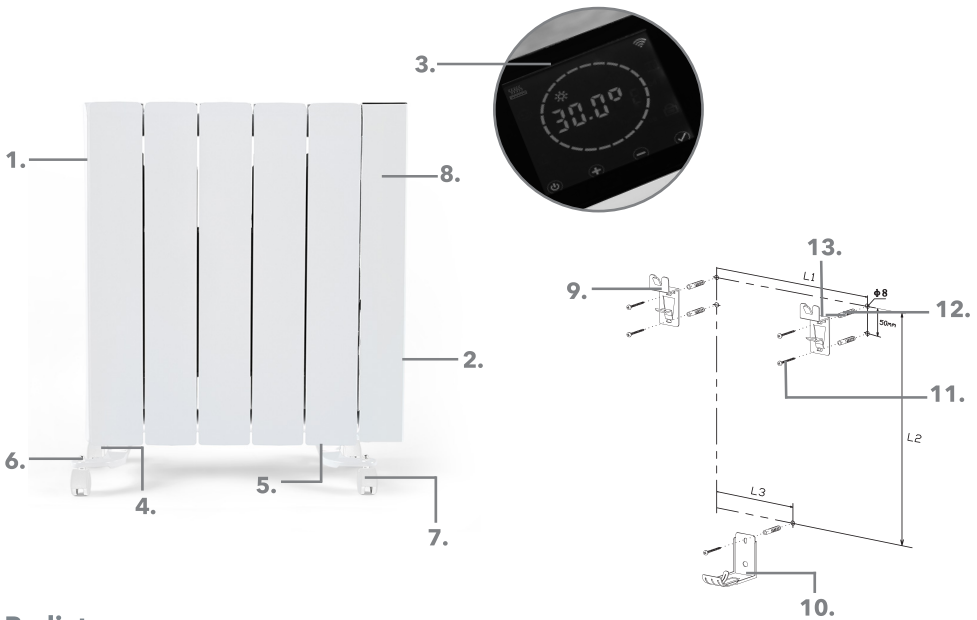







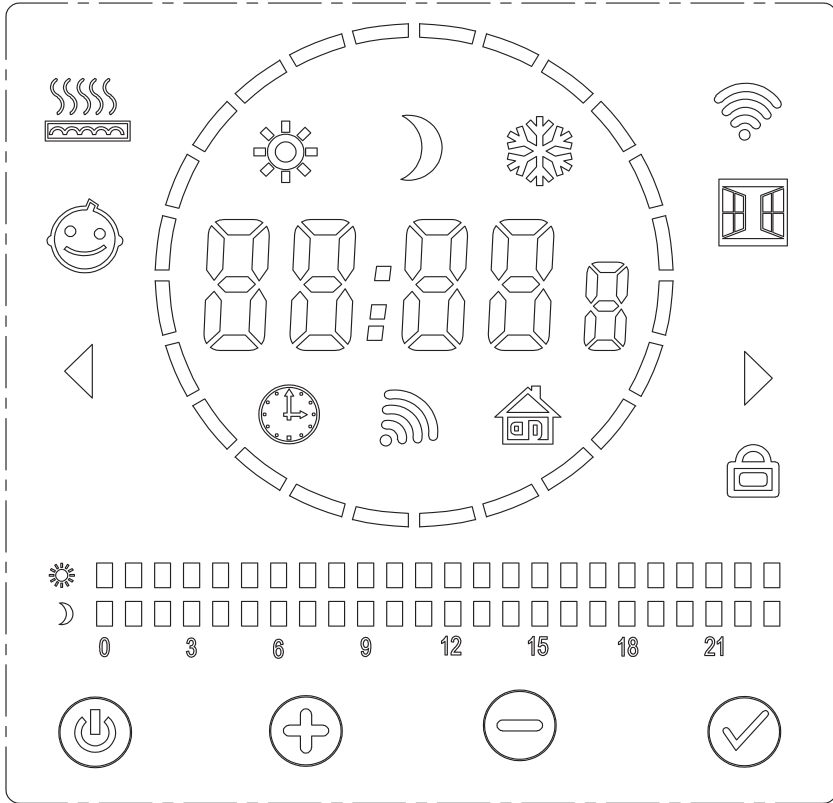











### Radiator

- |   |                                     |
|---|-------------------------------------|
| 1. 1500 W Smart Ceramic Core Radiator main unit | 7. 360 ° castor wheels (qty. 4)     |
| 2. On/off switch                                | 8. Fins                             |
| 3. Touchscreen panel                            | 9. Upper wall bracket (qty. 2)      |
| 4. Wing nut bolts (qty. 4)                      | 10. Lower wall bracket (qty. 1)     |
| 5. Wheel base units (qty. 2)                    | 11. Wall bracket screws (qty. 5)    |
| 6. Wheel nuts (qty. 4)                          | 12. Wall plugs (qty. 5)             |
|   | 13. Bracket locking screws (qty. 2) |

## Touch Screen Button and Symbols Diagram



Icon	Description	Icon	Description
	Multifunctional digital display		Heating icon
	Day of the week number (1 to 7)		Temperature limitation function
	Comfort mode		Wi-Fi icon
	Economic mode		Open window mode
	Frost prevention mode		Control panel lock activated
	Timer mode		Daily status bar (0 to 24 h)
	Sensor mode		Decrease button
	Programming mode		Mode button
	Power button		Increase button

## Before First Use

Do not connect the radiator to the mains power supply until all of the instructions have been read, fully understood and the radiator has been fully assembled.

The minimum safe distances must be observed.

Check that there is no damage to the radiator before assembly.

## Assembling the 1500 W Smart Ceramic Core Radiator

### Attaching the Wheels for Portable Use

**STEP 1:** Make sure the radiator is turned off and unplugged from the mains. Place the radiator on its side on a flat, stable surface, taking care not to damage the screen. Position the wheel base units at the bottom of the radiator with the flat side against the base and the bent ends pointing upwards, below the fins at either end of the radiator.

**STEP 2:** Attach the wheel base units to the bottom of the radiator, using the wing nuts to secure in place.

**STEP 3:** Secure the castor wheels onto the ends of the wheel base units using the wheel

nuts. The castor wheels should be firmly fixed, so that only the wheels are able to move.

**STEP 4:** Carefully turn the radiator back into its upright position. Position the radiator on a flat, stable, heat-resistant surface in an open space, at least 1 metre away from furniture, curtains or any other flammable materials.

**NOTE:** The radiator must be placed in a location with adequate ventilation where it is unlikely to be covered or damaged accidentally.

When using the radiator for the first time, a slight odour may be emitted. This is normal and will soon subside. Allow for sufficient ventilation around the radiator.

**CAUTION:** Do not leave the product operating unattended for extended periods of time

## Wall Mounting the 1500 W Smart Ceramic Core Radiator

The radiator should be mounted on a heat-resistant wall so that the bottom of it is at least 150 cm from the floor with a minimum space of 200 mm on all sides to allow for good air circulation. The radiator is not suitable for placing in an alcove; there should be as much clear space as possible above the radiator to allow for good heat dissipation and to reduce the risk of the product being covered accidentally.

**STEP 1:** Check that the wall the radiator is to be mounted on is strong and stable enough to support its weight and that it is heat-resistant to avoid cosmetic damage to the wall coverings. Make sure that the mounting position observes the safe distance requirements.

**STEP 2:** Using a pencil, mark the screw hole locations as described in the wall mounting diagram. Make sure that the holes are marked accurately and are in the positions required for the model. Check the marked positions are level and marked accurately before drilling the pilot holes.

**STEP 3:** Using a suitable drill bit, drill pilot holes at each marked location. Consult a qualified professional if required.

**STEP 4:** Insert a wall plug into each pilot hole so that the wall plug sits flush with the wall surface. Position the required mounting bracket onto the surface and fix to the wall with the wall bracket screws. The lower wall bracket should be fixed to the lowest set of pilot holes.

**STEP 5:** Place the radiator onto the support brackets, making sure that all of the brackets have engaged with the radiator and can support the weight.

**STEP 6:** Insert the bracket locking screws into the upper wall brackets and tighten to lock the radiator into the brackets.



**NOTE:** The radiator must be placed in a location with adequate ventilation where it is unlikely to be covered or damaged accidentally.

When using the radiator for the first time, a slight odour may be emitted. This is normal and will soon subside. Allow for sufficient ventilation around the radiator.

**CAUTION:** Make sure that there are no electrical, plumbing or gas suppliers situated beneath the surface of the wall. Testers are available from all good DIY stores.

Do not leave the radiator operating unattended for extended periods of time.

### Wall Mounting Diagram

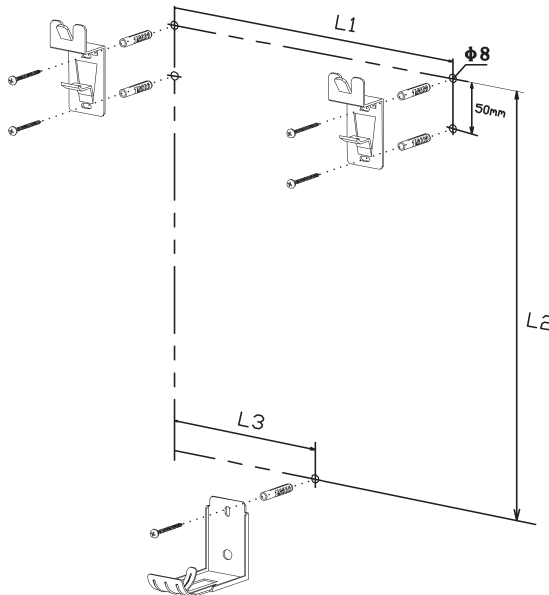



MODEL	L1 (mm)	L2 (mm)	L3 (mm)
1000 W	200	423	100
1500 W	300	423	200
2000 W	400	423	200



## Instructions for Use

**STEP 1:** Plug in and switch on the radiator at the mains power supply.

**STEP 2:** To turn on the radiator, press the on/off switch to the "I" position. The screen will display all available digits and symbols before going into standby mode.

**STEP 3:** Press  to turn the radiator on. The display will change to comfort mode and display the comfort mode temperature.



**STEP 4:** Press  to increase the temperature in 0.5 °C increments. When the desired temperature is shown on the screen, press  to confirm. The temperature is now set and the radiator will begin heating the room to the set temperature.



**STEP 5:** Press  to decrease the temperature in 0.5 °C increments. When the desired temperature is shown on the screen, press  to confirm. If the set temperature is higher than the current ambient room temperature, the radiator will display  and begin heating the room.

**STEP 6:** Press  to put the radiator into standby mode. The time will be displayed on the screen if it is set, otherwise the digits will flash as a reminder. Switch off the radiator using the on/off switch located on the right-hand side of the radiator main unit.

**NOTE:** The comfort mode temperature must be set higher than the current room temperature for the heat setting to engage. All of the functions are available to use without connecting to the app.

## Enabling and Disabling the Control Panel Lock

To enable the control panel lock, press and hold  and  simultaneously until  appears. This will deactivate all of the controls except for the power button and on/off switch.

To deactivate the control panel lock, press and hold  and  simultaneously until  disappears.

**NOTE:** The control panel lock cannot be enabled or disabled when the radiator is in standby mode. Turning the radiator off with the on/off switch will disable the Control Panel lock.

## Advanced Operation

### Modes of Operation

The radiator has 5 modes which can be programmed and set for convenience:

**COMFORT MODE** (☀️) - the radiator will maintain the set temperature.

**ECONOMIC MODE** (🌙) - the radiator will maintain the set temperature. For most efficient operation, do not set the temperature higher than comfort mode.

**FROST PREVENTION MODE** (❄️) - the radiator will be set to 7 °C to prevent frost. The set temperature for this mode cannot be changed.

**SENSOR MODE** (📶) - the radiator will operate in comfort mode when people are detected in the room. When people are no longer detected in the room the radiator will change to economic mode and then frost prevention mode, until people are detected again. This mode must be programmed from the Internal Set up menu before it will operate correctly when selected.

**TIMER MODE** (🕒) - the radiator will run on a programmed timer setting and will automatically change from comfort to economic mode at specific times.

To change the mode, press '✔️' to cycle between modes in order:

☀️ → COMFORT MODE → 🌙 ECONOMIC MODE → ❄️ FROST PREVENTION MODE → 🕒 TIMER MODE → 📶 SENSOR MODE

The mode can also be changed by swiping the touch screen left or right to scroll through the programmes.

**NOTE:** Sensor mode must be programmed by following the instructions in the section entitled 'More Advanced Operation'. It is not possible to adjust the temperature whilst the sensor mode icon is flashing. Press '✔️' again to select comfort mode and adjust the temperature.

### Setting the Time and Timers

**STEP 1:** Navigate to TIMER mode (🕒) by pressing '✔️'. Press and hold '✔️' until the hour digits begin to flash inside a circle. Use '+' and '-' to set the hour and then press '✔️' to confirm.

**STEP 2:** The minute digits will now flash. Use '+' and '-' to set the minutes and then press '✔️' to confirm.

**STEP 3:** The day of the week number will now flash. Use **+** and **-** to set the day of the week number:

- 1 = Monday
- 2 = Tuesday
- 3 = Wednesday
- 4 = Thursday
- 5 = Friday
- 6 = Saturday
- 7 = Sunday

Press **✓** to confirm.

**STEP 4:** The programme number "P1" will be displayed in the left-hand side of the circle alongside the day of the week number in the right-hand side.

The times the comfort and economic mode are engaged for are displayed along the bottom of the screen in the daily status bar in blocks of 1 hour.

Use **+** and **-** to change the programme number to the desired programme for the selected day. There are seven programmes to choose from.

When the desired programme has been selected, press **✓** to confirm. The programme for the following day can now be selected in the same way until a programme has been assigned for every day of the week.

When all of the days of the week have been programmed, the display will return to the home display screen. A flashing block on the daily status bar shows where in the programme the radiator is. The time is now set and will be displayed on the screen when the radiator is in standby mode.

## Programming the Daily Schedule

The programme for each day can be customised to the user's requirements for maximum convenience. To customise a programme, follow steps 1-3 of the section entitled 'Setting the Time and Timers'. The programme number "P1" will be displayed in the left-hand side of the circle alongside the day of the week number in the right-hand side.

**STEP 1:** Press and hold **✓** until the digits '00' flash next to the programme number and the first bar on the Daily Status Bar flashes. The hour time period each bar represents will be displayed in a 24-hour format alongside the programme number as the bar is selected.

**STEP 2:** Press **+** to toggle comfort mode on for the time period selected. Press **-** to toggle comfort mode off for the time period selected.

When either button is pressed, the next bar will automatically be selected for modification.

Press and hold either button to quickly toggle and set multiple bars in a short period of time.

Press and hold **+** to toggle comfort mode on for the selected time period.

Press and hold **-** to toggle comfort mode off for the selected time period.

**STEP 3:** When customisation is complete, press **✓** to save the settings for that day. The next Daily programme to be customised can be selected with **+** or **-** in the same way.

## Resetting to Factory Settings



To reset the radiator to factory settings, make sure that the radiator is in standby mode. Press and hold  until the screen displays all digits and symbols then release it. This will clear all existing user customised settings and can now be reprogrammed.

## More Advanced Operation



### Internal Set-up Menu

More advanced features and settings, including the Wi-Fi settings, can be accessed through the internal set-up menu:

- F0:** Temperature Compensation
- F1:** Sensor Mode Function
- F2:** Open Window Function
- F3:** Temperature Limitation Function
- F4:** Wi-Fi Function

To access the internal set-up menu the radiator must be in standby mode. Press and hold  until "F0" appears on the left-hand side of the circle. The current set value will be displayed on the right-hand side of the circle. Press  to cycle through the functions in ascending order.

### F0: Temperature Compensation

This allows the thermostat on the radiator to be calibrated to the true room temperature. Press  to increase the temperature and press  to decrease it. The temperature can be adjusted to compensate for temperature differences of +/- 5 °C in 1 °C increments. When the desired level of compensation is set, press  to confirm and move to the next function.

### F1: Sensor Mode Function

This is the amount of time the radiator will continue to heat the room after people are no longer detected in the sequence described below.

1st time period	The room will be heated at comfort temperature.
2nd time period	If no motion is detected, the room will be heated at 1 °C below comfort temperature.
3rd time period	If no motion is detected, the room will be heated at 2 °C below comfort temperature.
4th time period	If no motion is detected, the room will be heated at economic temperature.

If no motion is detected for 24 hours after 4th time period: the room will be heated at frost-prevention temperature.

If a person is detected, the sequence will be reversed with the radiator moving back 1 time period each time a person is detected until the original comfort temperature is reached.

There are 5 time period options available: '0' (Off), 15, 30, 45 and 60 minutes. Press **+** to increase the time setting and then press **-** to decrease it. When the desired time period is set, press **✓** to confirm and move to the next function.

## F2: Open Window Function

If the radiator detects that the room temperature has dropped more than 2 °C within 5 minutes (for example, if a window is opened), the radiator will change to frost-prevention mode to save energy for the time period selected before reverting to the previous mode to reheat the room.

There are three time period options available: '0' (Off), 60 and 90 minutes. Press **+** to increase the time setting and then press **-** to decrease it. When the desired time period is set, press **✓** to confirm and move to the next function.

## F3: Temperature Limitation Function

The radiator will automatically limit the max. temperature of the unit to reduce the risk of burns and scalds.

There are 6 settings: '0' (Off), 40 °C, 45 °C, 50 °C, 55 °C and 60 °C. Press **+** to activate the function. The  will be displayed to show the mode is activated. Press **+** or **-** to increase/decrease the temperature. When the desired temperature is set, press **✓** to confirm and move to the next function.

**NOTE:** The heating element will switch off when the radiator reaches the temperature set. This is controlled by an internal temperature sensor and does not represent the external surface temperature of the radiator. Limiting the temperature of the radiator in this way will limit the effectiveness with which it heats the room.

**WARNING:** Keep children and vulnerable people away from the radiator to reduce the risk of injury.

#### F4: Wi-Fi Function

**IMPORTANT:** Before attempting to connect the device via Wi-Fi, ensure the router has been split into 2.4 GHz and 5 GHz networks and the mobile device is connected to the 2.4 GHz network. The radiator is only compatible with 2.4 GHz bandwidth. Please contact the internet service provider for instructions on splitting the 2.4 GHz and 5 GHz bandwidths.

This allows the radiator to be connected to a Wi-Fi network and controlled from a smartphone app. The radiator can still function normally without Wi-Fi connection but adjustments can only be made from the control panel and not remotely. Press **+** to turn on the Wi-Fi function; 'on' will be displayed on the screen. Press **-** to turn off the Wi-Fi function; 'oF' will be displayed on the screen. Press **✓** after set up to exit the internal set up menu.



#### F5: Time Synchronisation

This allows the radiator to sync the time with a connected mobile device. Press **+** and **-** to switch between "on" and "off". When switched off, the internal clock of the radiator will be used.

#### Connecting the Radiator to the Smartphone App

Download and install the Tuya Smart Life app on a compatible device. Register an account and ensure that the mobile device is connected to the same 2.4 GHz Wi-Fi network as the radiator.

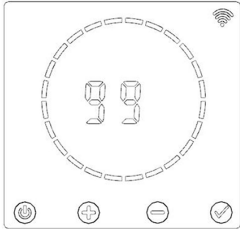
## Smart Radiator Quick Set-Up Steps

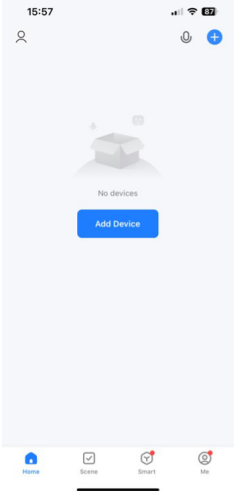
Stage:	Description:	Image:
1	Make sure the radiator is plugged in and the Wi-Fi function is enabled, following the instructions in the section entitled 'F4: Wi-Fi Function'.	
2	With the radiator in standby, press and hold  until the screen shows a countdown.	
3	On the mobile device, ensure that the Tuya Smart Life App is set-up and ready to connect.	
4	Open the Smart Life App. Once signed into the app, select 'add device'.	

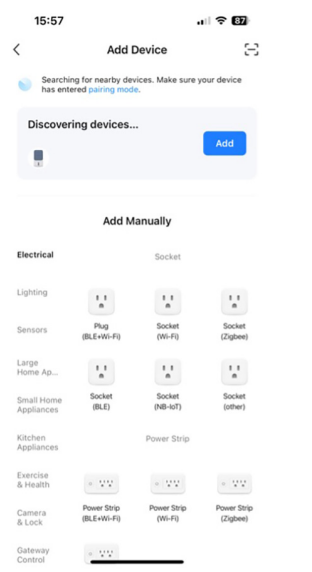
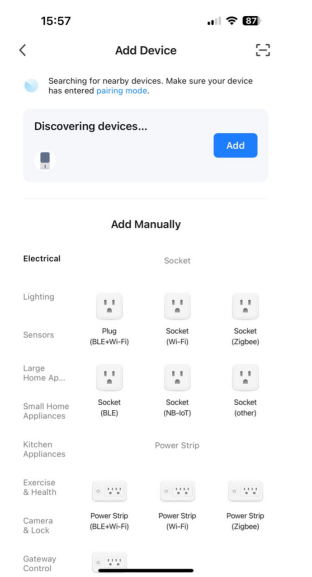

<p>5</p>	<p>Once 'add device' has been selected, the app will display a new screen; select 'Auto Scan' on the selection pane at the top of the app. A circle should begin to flash to signal the app is looking for a device to pair with.</p>	 <p>15:57</p> <p>Add Device</p> <p>Searching for nearby devices. Make sure your device has entered pairing mode.</p> <p>Discovering devices... Add</p> <p>Add Manually</p> <p>Electrical Socket</p> <p>Lighting</p> <p>Sensors Plug (BLE+Wi-Fi) Socket (Wi-Fi) Socket (Zigbee)</p> <p>Large Home Ap... Socket (BLE) Socket (NB-IoT) Socket (other)</p> <p>Small Home Appliances</p> <p>Kitchen Appliances Power Strip</p> <p>Exercise &amp; Health</p> <p>Camera &amp; Lock Power Strip (BLE+Wi-Fi) Power Strip (Wi-Fi) Power Strip (Zigbee)</p> <p>Gateway Control</p>
<p>6</p>	<p>The device should then appear with the "add" button next to it.</p>	 <p>15:57</p> <p>Add Device</p> <p>Searching for nearby devices. Make sure your device has entered pairing mode.</p> <p>Discovering devices... Add</p> <p>Add Manually</p> <p>Electrical Socket</p> <p>Lighting</p> <p>Sensors Plug (BLE+Wi-Fi) Socket (Wi-Fi) Socket (Zigbee)</p> <p>Large Home Ap... Socket (BLE) Socket (NB-IoT) Socket (other)</p> <p>Small Home Appliances</p> <p>Kitchen Appliances Power Strip</p> <p>Exercise &amp; Health</p> <p>Camera &amp; Lock Power Strip (BLE+Wi-Fi) Power Strip (Wi-Fi) Power Strip (Zigbee)</p> <p>Gateway Control</p>

7	Select "Add" to pair to the device.	
8	At this point, the network Wi-Fi password may need to be entered.	
9	The message 'added successfully' will be displayed on the mobile device and the message 'PASS' will be displayed on the radiator control panel. Click on the icon of the device to begin controlling the device functions.	

## Troubleshooting

Problem	Cause	Solution
The radiator is not operating.	<p>The radiator is not plugged in and switched on at the mains power supply.</p> <p>The thermal cut-out device has activated.</p> <p>The fuse has blown.</p>	<p>Check that the radiator is plugged in and switched on at the mains power supply.</p> <p>Unplug the radiator from the mains power supply and allow it to cool for approx. 30 minutes. Plug in and switch on the radiator at the mains power supply before trying again.</p> <p>Unplug the radiator from the mains power supply and replace the fuse with one that is the same amp.</p>

There is no heat or light being emitted from the radiator.	There may be a problem with the power supply to the radiator.	Check the mains power supply by plugging in a working product. If the mains power supply is functional and the power cord or plug of the radiator is suspected to be faulty, have it checked by a qualified electrician.
The radiator will not connect to the smartphone app	<p>The radiator may not be close enough to the Wi-Fi router to obtain a good connection.</p> <p>The smartphone app may not be connected to the Wi-Fi network.</p>	<p>Move the radiator closer to the Wi-Fi router and try to connect again.</p> <p>Check that the smartphone app is connected to the same Wi-Fi network that you intend to connect the radiator to.</p>

## High and low temperature alarm

Temperature Display shows	Condition
LL 1	Ambient temperature lower than -20 °C
LL 2	Internal temperature lower than -20 °C
HH 1	Ambient temperature is over 47 °C
HH 2	Internal temperature is over 85 °C

## Error codes

Temperature Display shows	Condition
Er 1	Temperature sensor open circuit or lower than 0 °C
Er 2	Temperature sensor short circuit or higher than 94 °C

## Declaration of Conformity

UP Global Sourcing UK Ltd. hereby declares that this unit is in compliance with the essential requirements and other provisions of directive 2014/53/EU.

The declaration of conformity may be consulted at UP Global Sourcing UK Ltd., Victoria Street, Manchester OL9 0DD. **UK.** Edmund-Rumpler Straße 5, 51149 Köln. **Germany.** or online at <https://beldray.com/declaration-letters/> Model No. EH3109V2

## Specifications

Product code: EH3109V2

Supply: 220-240V ~ 50 Hz

Power: 1500 W

Operating frequency: 2.4 GHz

Max RF output: < 20 dBm

## ERP Table

Item	Symbol	Value	Unit	Item	Unit
<b>Heat Output</b>				<b>Type of heat input for electric storage local space heaters only.</b>	
Nominal heat output	$P_{nom}$	1.5	kW	Manual heat charge control, with integrated thermostat.	No
Nominal heat output (indicative)	$P_{min}$	1.5	kW	Manual heat charge control with room and/or outdoor temperature feedback.	No
Maximum continuous heat output	$P_{max,c}$	1.5	kW	Electronic heat charge control with room and/or outdoor temperature feedback.	No
<b>Auxiliary electricity consumption</b>				Fan assisted heat output.	No
At nominal heat output	$e_{l_{max}}$	n/a	kW	<b>Type of heat output/room temperature control (select one).</b>	
At minimum heat output	$e_{l_{min}}$	n/a	kW	Single stage heat output and no room temperature control.	No
In standby mode	$e_{l_{SB}}$	1.05	kW	Two or more manual stages, no room temperature control.	No
				With mechanic thermostat room temperature control.	Yes
				With electronic room temperature.	No
				Electronic room temperature control plus day timer.	No
				Electronic room temperature control plus week timer.	Yes
				<b>Other control options</b>	
				Room temperature control, with presence detection.	Yes
				Room temperature control, with open window detection.	Yes
				With distance control option.	Yes
				With adaptive start control.	No
				With working time limitation.	Yes
				With black bulb sensor.	No

## Connection to the mains

Please check that the voltage indicated on the product corresponds with your supply voltage.

### Important

As the colours in the mains lead of this appliance may not correspond with the coloured markings identifying the terminals in your plug, please proceed as follows:

The wires in the mains lead are coloured in accordance with the following code:

Blue Neutral (N)

Brown Live (L)

Green/Yellow Earth ( $\perp$ )

FOR UK USE ONLY - Plug fitting details (where applicable).

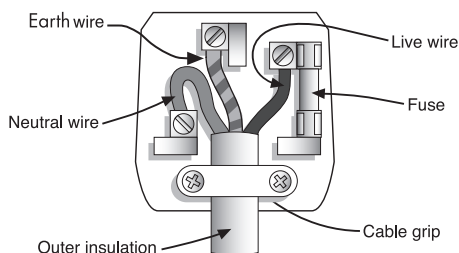

The wire coloured BLUE is the NEUTRAL and must be connected to the terminal marked N or coloured BLACK.

The wire coloured BROWN is the LIVE wire and must be connected to the terminal marked L or coloured RED.

The wire coloured GREEN/YELLOW must be connected to the terminal marked with the letter E or marked  $\perp$ .

On no account must either the BROWN or the BLUE wire be connected to the EARTH terminal ( $\perp$ ).

Always ensure that the cord grip is fastened correctly.

The plug must be fitted with a fuse of the same rating already fitted and conforming to BS 1362 and be ASTA approved.

If in doubt consult a qualified electrician who will be pleased to do this for you.

## Non-rewireable mains plug

If your appliance is supplied with a non-rewireable plug fitted to the mains lead and should the fuse need replacing, you must use an ASTA approved one (conforming to BS 1362 of the same rating).

If in doubt, consult a qualified electrician who will be pleased to do this for you.

If you need to remove the plug - DISCONNECT IT FROM THE MAINS and then cut it off the mains lead and immediately dispose of it safely. Never attempt to reuse the plug or insert it into a socket outlet as there is a danger of an electric shock.

**UP Global Sourcing UK Ltd.,  
Victoria Street, Manchester OL9 0DD. UK.  
Edmund-Rumpler Straße 5, 51149 Köln. Germany.**

If this product does not reach you in an acceptable condition please contact our Customer Services Department at [www.beldray.com](http://www.beldray.com)

Please have your delivery note to hand as details from it will be required.

If you wish to return this product please return it to the retailer from where it was purchased with your receipt (subject to their terms and conditions).

## **Guarantee**

All products purchased as new carry a manufacturer's guarantee; the time period of the guarantee will vary dependent upon the product. Where reasonable proof of purchase can be provided, Beldray will provide a standard 12 month guarantee with the retailer from the date of purchase. This is only applicable when products have been used as instructed for their intended, domestic use. Any misuse or dismantling of products will invalidate any guarantee.

Under the guarantee, we undertake to repair or replace free of any charge any parts found to be defective. In the event that we cannot provide an exact replacement, a similar product will be offered or the cost refunded. Any damages from daily wear and tear are not covered by this guarantee, nor are consumables such as plugs, fuses etc.

Please note that the above terms and conditions may be updated from time to time and we therefore recommend that you check these each time you revisit the website.

Nothing in this guarantee or in the instructions relating to this product excludes, restricts or otherwise affects your statutory rights.

## **Disposal of Waste Batteries and Electrical and Electronic Equipment**



This symbol on the product, its batteries or its packaging means that this product and any batteries it contains must not be disposed of with household waste. Instead, it is the user's responsibility to hand this over to an applicable collection point for the recycling of batteries and electrical and electronic equipment. This separate collection and recycling will help to conserve natural resources and prevent potential negative consequences for human health and the environment due to the possible presence of hazardous substances in batteries and electrical and electronic equipment, which could be caused by inappropriate disposal. Some retailers provide take-back services which allow the user to return exhausted equipment for appropriate disposal. **It is the user's responsibility to delete any data on electrical and electronic equipment prior to disposal.** For more information about where to drop batteries, electrical and electronic waste off, please contact the local city/municipality office, household waste disposal service, or the retailer.



\*To be eligible for the extended guarantee, go to <https://guarantee.upgs.com/beldray> and register your product within 30 days of purchase.

Find us on 

[www.facebook.com/Beldray](http://www.facebook.com/Beldray)



Manufactured by:  
UP Global Sourcing UK Ltd.,  
Victoria Street, Manchester OL9 0DD. **UK.**  
Edmund-Rumpler Straße 5, 51149 Köln. **Germany.**

[www.beldray.com](http://www.beldray.com)



©Beldray Trademark. All rights reserved.

CD230519/MD210323/V4