

Features

- Includes faceplate with handle
- A single handle controls both on/off activation and temperature setting
- Complements Artifacts faucets and accessories

Material

- Premium material construction with metal handle ensures reliability and durability
- KOHLER® finishes resist corrosion and tarnishing

Installation

- Trim only; requires valve to complete installation (sold separately)

Required Products/Accessories

K-8304 Series Rite-Temp® Valve & Cartridge Kits

or

K-8300 Series Rite-Temp® Valve Body Rough-ins

K-8305 Series Rite-Temp® Cartridges

Recommended Products/Accessories

K-23723 Faucet cleaner

Optional Products/Accessories

K-10350 Deep rough-in kit

K-10351 Test cap for K-8300 Series valve bodies



ADA

CSA B651

Codes/Standards

ASME A112.18.1/CSA B125.1

ADA

ICC/ANSI A117.1

CSA B651









IAPMO Certification

KOHLER® Faucet Lifetime Limited Warranty

See website for detailed warranty information.

Available Colors/Finishes

Color tiles intended for reference only.

Color	Code	Description
	CP	Polished Chrome
	SN	Vibrant® Polished Nickel
	AF	Vibrant® French Gold
	BN	Vibrant® Brushed Nickel
	BV	Vibrant® Brushed Bronze
	BL	Matte Black
	2MB	Vibrant® Brushed Moderne Brass
	TT	Vibrant Titanium
	DR	Deep Bronze

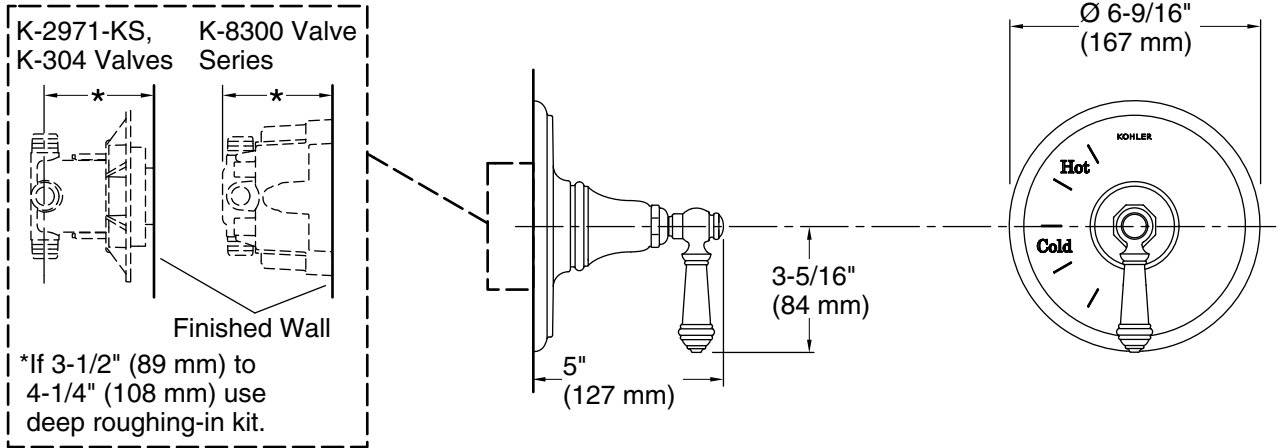

Technical Information

All product dimensions are nominal.

Handshower:

Rated maximum flow: 0 gal/min (0 l/min)

Notes

Install the product according to the installation guide.

NOTICE: Risk of product damage. Long screws for installing trim can damage the K-2971-KS valve. Consult the trim installation guide to verify if the thin wall installation kit (88526) is needed.

ADA, CSA B651 compliant when installed to the specific requirements of these regulations.