

# FLEXSTEEL®

## Power Reclining Loveseat with Console, Power Headrests, Lumbar, Heat & Massage

### IMPORTANT NOTE

Read these instructions carefully, and familiarize yourself with each procedure before assembling the furniture. Check that you have all the component parts, and familiarize yourself with each part before proceeding.

Take all the fittings out of the plastic bag and separate them into groups. Ensure you have enough space to lay out all the parts before assembly. To prevent damage to the parts, we recommend that you assemble the unit on a soft, flat surface.

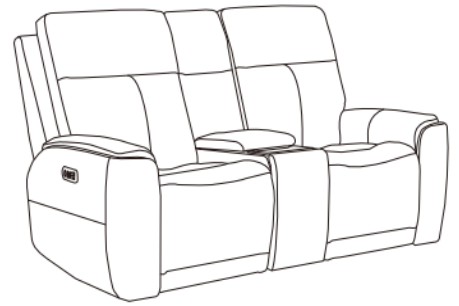

### Part List

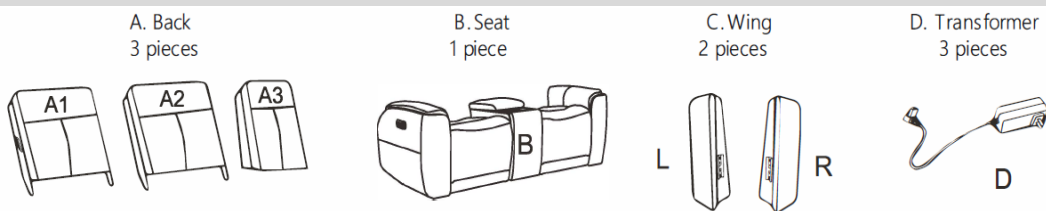

### Assembly Instructions

#### STEP 1

Take out the Transformers (D) and Wings (C) from the bottom of the seat. (See Figure 1)

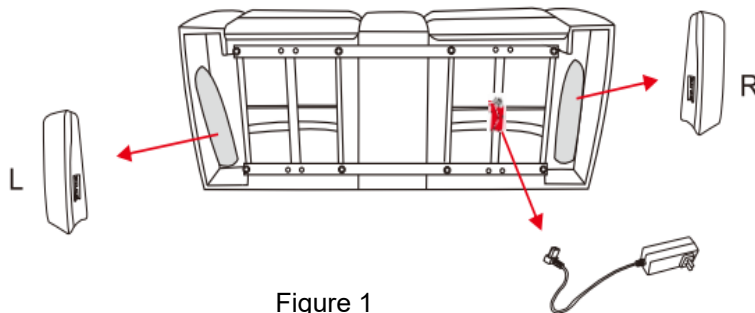

#### STEP 2

Attach Left Back (A1), Middle Back (A3), and Right Back (A2) to Seat (B), ensure the brackets fit tightly. Insert Left and Right Wings to Left and Right Backs (A1 & A2), ensure the Wings are fixed securely. (See Figure 2)

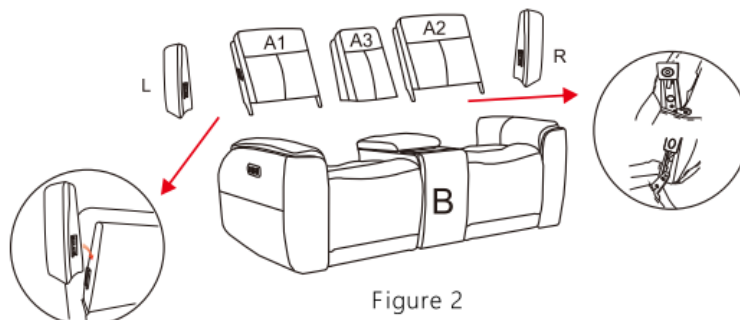

### STEP 3

Zip the fabric on bottom of the Left and Right Backs (A1 & A2) with back of Seat (B). (See Figure 3).

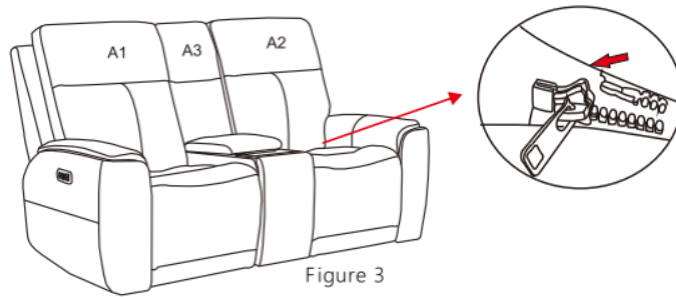

### STEP 4

Flip up the back flap, and remove the cables from the Left and Right Backs (A1 & A2). Connect the cables with red labels together, and then connect the cables with labels A to A, B to B, C to C. (See Figure 4)

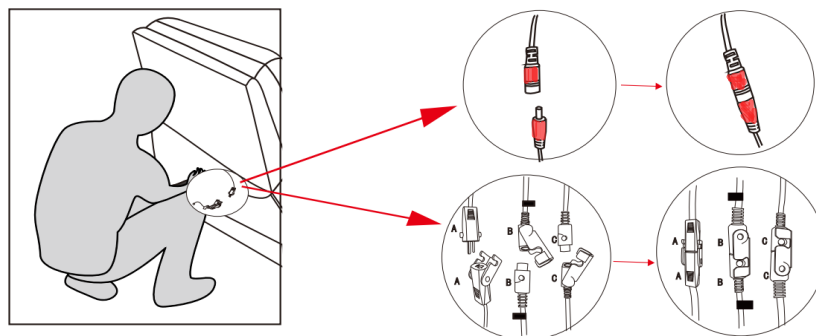

Figure 4

### STEP 5

Connect the transformers (D) into the power ports on the back of the left & right seats and the back of the console on the seat (B). Plug them into nearby outlets, still making sure they are clear of the metal base. Fasten the back flaps to the bottom of the furniture. (See Figure 6)

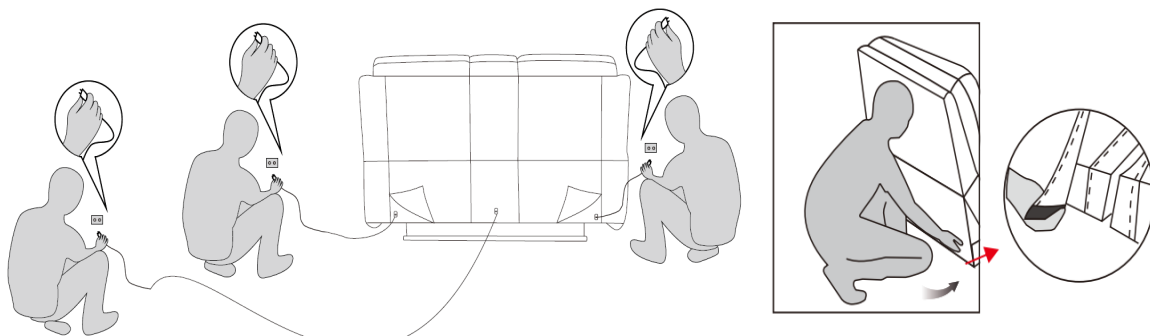

Figure 5

Figure 6

## Back Disassembly

Pull up the spring leaf in bracket, then lift Back (A) up. Unzip the black fabric on bottom of back from back of seat. Disconnect all of the cables behind the backs. (See figure 7)

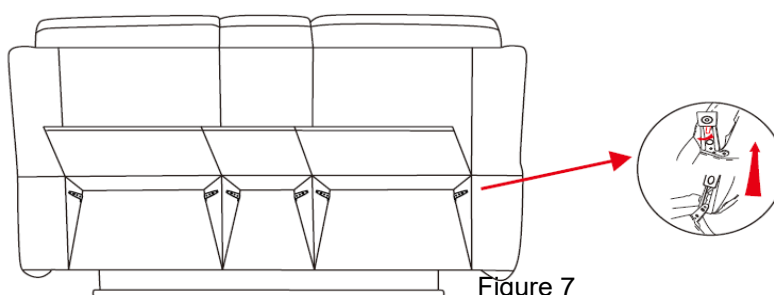
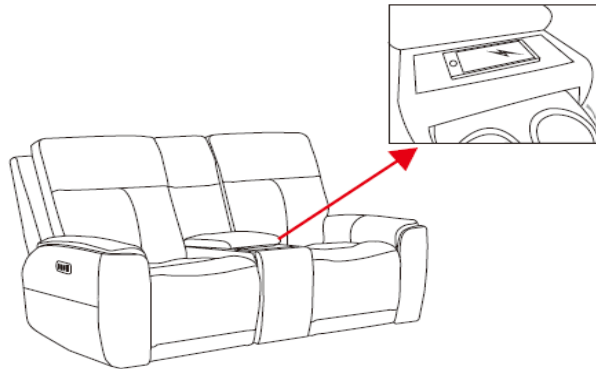

Figure 7

## Wireless Charging Pad

You can charge with your Qi compatible device on the wireless charging pad.



## User Guide for Wireless Charger

### Attention



1. It is common for heat to be generated in wireless charging through the energy transfer process. This is part of the normal wireless energy transfer.
2. Phone should be centered on the wireless charging icon if an icon is present. The further the current must travel, charging efficiency is reduced and more energy is lost to heat.
3. Phone should be centered on the tray if an icon is not present. The further the current must travel, charging efficiency is reduced and more energy is lost to heat.
4. Make sure there aren't any foreign objects on the charger when charging. This can cause the charger to start stop multiple times if the foreign object detector senses an object.
5. Make sure to disconnect the phone from Apps and WiFi during wireless charging while charging and don't use the phone while wireless charging.

### IMPORTANT NOTE

- To avoid any risk of suffocation to children or pets dispose of all plastic bags immediately
- To ensure proper performance occasionally check for loose screws and tighten as needed.
- If the reclining functions are not working properly, check for loose cable connections before contacting the retailer.