

ASSEMBLY INSTRUCTION

E557-60 60" DINING TABLE

A TABLE TOP

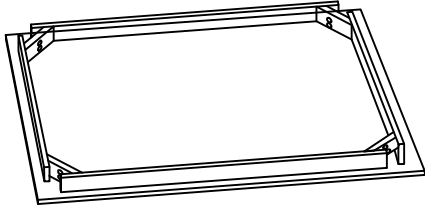

1 pc

B TABLE LEG

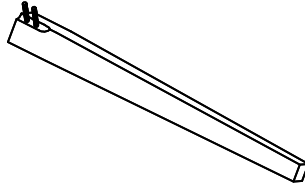

4 pcs

C HEX NUT
Ø 5/16" x 12 mm

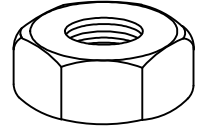

8 pcs

D FLAT WASHER
Ø 5/16" x 19 mm

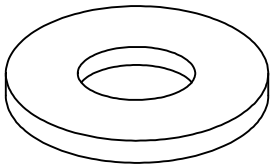

8 pcs

E LOCK WASHER
Ø 5/16" x 13 mm

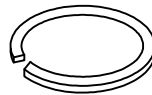

8 pcs

F WRENCH
12 mm

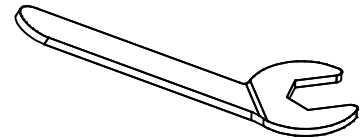

1 pc

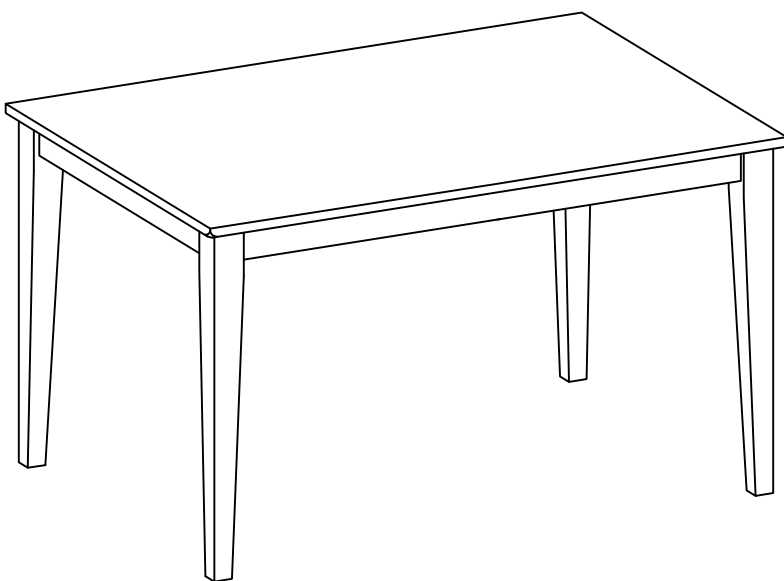

This page lists all the contents included in the box. Please take the time to identify the hardware as well as the individual components to this product. As you unpack and prepare for assembly, place the contents on a carpeted or padded area to protect them from damage.

1 Place the Table Top (A) up side down on the floor with a piece of cloth or carpet underneath to prevent the finish from scratching. Attach the Table Leg (B) to Table Top (A) using Flat Washer (D), Lock Washer (E) and Hex Nut (C) by Wrench (F). Do not fully tighten.

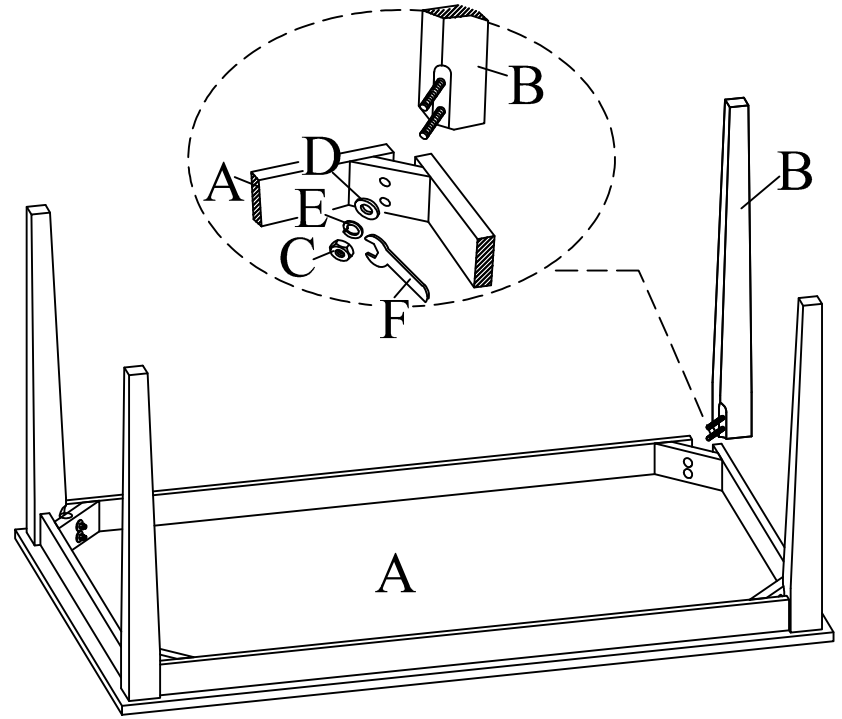

2 Turn the Table to upright position, place it on flat surface and adjust legs so that Table is level and does not wobble. Assembly product is now completed .

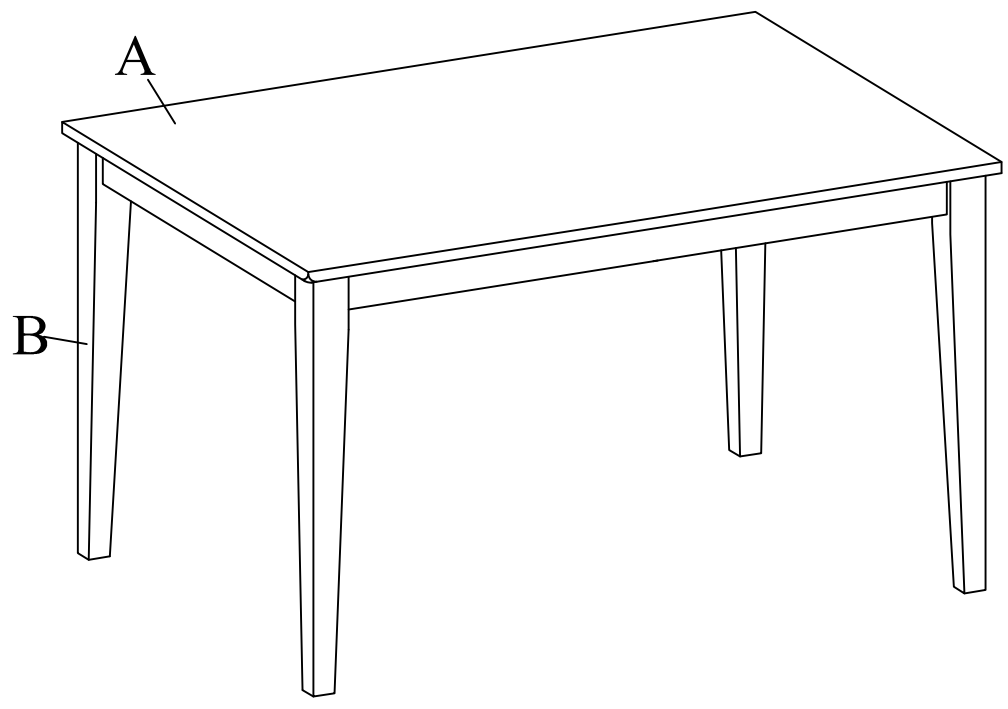

Cleaning & Care :
Treat surface with care. Surface is resistant to scratches but is not scratch resistant. Clean surface with a dry or damp soft cloth. Do not use abrasive cleaners. Hardware may loosen over time. Periodically check that all connections are tight.