

RKCONU1708GB/EU
RKCONU1716GB/EU
RKCONU1908GB/EU
RKCONU1916GB/EU

RACKCONU1708
RACKCONU1716
RACKCONU1908
RACKCONU1916
Instruction Manual

Folding Rackmount Console with KVM Switch

17" LCD Rackmount Console with 8 Port KVM

17" LCD Rackmount Console with 16 Port KVM

19" LCD Rackmount Console with 8 Port KVM

19" LCD Rackmount Console with 16 Port KVM



DURAVIEW

StarTech.com



Making hard-to-find easy!®

FCC Compliance Statement

This equipment has been tested and found to comply with the limits for a Class B digital device, pursuant to part 15 of the FCC Rules. These limits are designed to provide reasonable protection against harmful interference in a residential installation. This equipment generates, uses and can radiate radio frequency energy and, if not installed and used in accordance with the instructions, may cause harmful interference to radio communications. However, there is no guarantee that interference will not occur in a particular installation. If this equipment does cause harmful interference to radio or television reception, which can be determined by turning the equipment off and on, the user is encouraged to try to correct the interference by one or more of the following measures:

- Reorient or relocate the receiving antenna.
- Increase the separation between the equipment and receiver.
- Connect the equipment into an outlet on a circuit different from that to which the receiver is connected.
- Consult the dealer or an experienced radio/TV technician for help.

Use of Trademarks, Registered Trademarks, and other Protected Names and Symbols

This manual may make reference to trademarks, registered trademarks, and other protected names and/or symbols of third-party companies not related in any way to StarTech.com. Where they occur these references are for illustrative purposes only and do not represent an endorsement of a product or service by StarTech.com, or an endorsement of the product(s) to which this manual applies by the third-party company in question. Regardless of any direct acknowledgement elsewhere in the body of this document, StarTech.com hereby acknowledges that all trademarks, registered trademarks, service marks, and other protected names and/or symbols contained in this manual and related documents are the property of their respective holders.

Table of Contents

Introduction	1
Packaging Contents.....	1
Installation	1
Hardware Installation.....	2
Connecting the Console/Module	4
Connecting computers to the module.....	6
Cascade Configuration	6
Turning on the console	7
Configuring display settings.....	7
Testing the console.....	8
Panel controls and OSD functions.....	9
Module operation	12
OSD Selection.....	12
Hot-key commands.....	16
Specifications	19
Technical Support	21
Warranty Information	21

Introduction

Packaging Contents

- 1 x 1U LCD Rack Console Drawer
- 1 x 1U Multi-Platform KVM Switch
- 1 x Mounting Brackets
- 1 x Mounting Rails - Set
- 1 x Power Adapter

Installation

Hardware Kit Contents

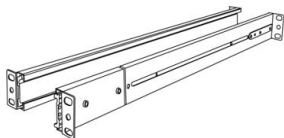

Side Rails with front and rear brackets (2)



Screw kit



Keys (2)

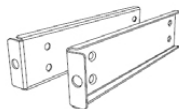

Mounting Brackets

Please note: RACKCONU1708/1716/1908/1916 and RKCONU1708xx/1716xx/1908xx/1916xx (where 'xx' is 'GB' or 'EU') are comprised of two distinct components - a Rackmountable Console and a Rackmountable KVM Module, as illustrated below. The two devices are attached via a Centronics connector on the Rear panel of the Console and similarly the front panel of the Module.

Multi-Port KVM Module

Front Panel



Rear Panel



* 16-port module shown

Console

Front View, Open



Hardware Installation

Mounting the console

1. Loosen the rear screws (pre-installed in side rails) and adjust the length of the rear bracket to fit the depth of your cabinet:

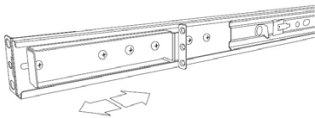
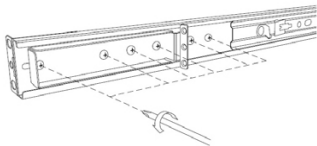

2. Install the rails into the cabinet:

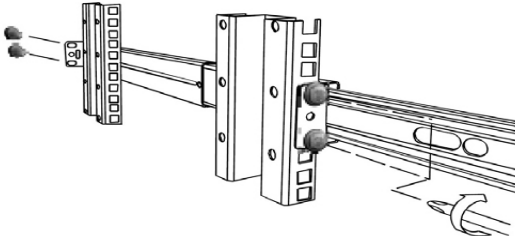

3. Tighten the screws that were loosened in Step 1:

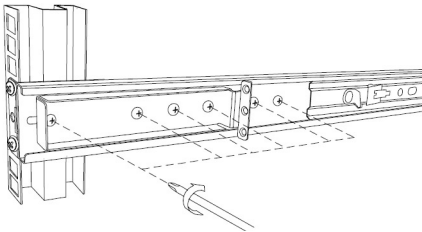

4. Install the remaining rail, repeating Steps 1-3.
5. Slide the Module onto the Console side rails, connecting the Module and Console using the male Centronics connector provided by the Console, and the female Centronics connector provided by the Module. Ensure the connection is secure, and that the module is firmly seated within the Console side rails.
6. Gently, but firmly insert the Console (with Module attached) into the left and right rails:

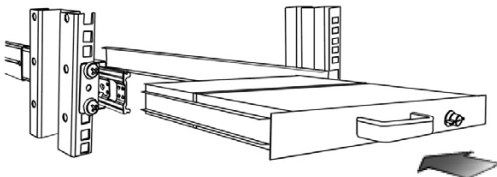

7. Unlock the console, and pull the left and right rail-lock switches towards you simultaneously, and hold them in this position while pushing the console into the cabinet:

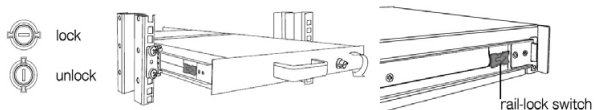

8. Install three screws on each side of the console:

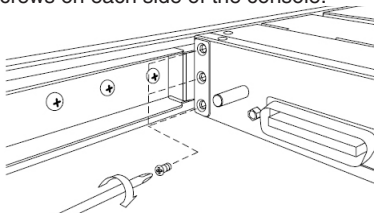

9. Installation is now complete.

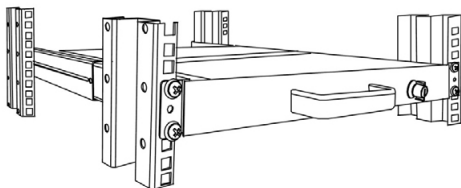

Connecting the Console/Module

To connect the KVM Console/Module to a computer, perform the following steps:

1. Remove the four screws from both sides of the KVM console. Be sure to retain these screws for the next installation step.

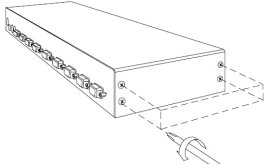

2. Attach the mounting brackets to both sides of the KVM console, using the screws removed in step 1.

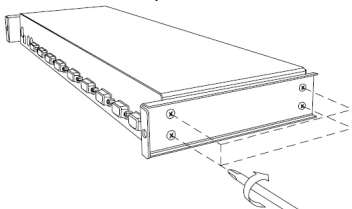

3. From the rear of the cabinet, slide the KVM console onto the mounting rails.

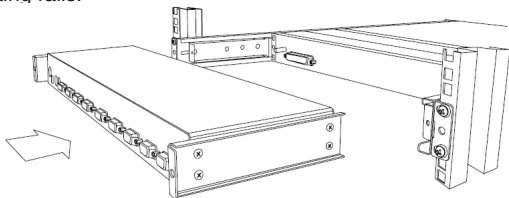

4. Install one screw on each side of the console (as depicted below).

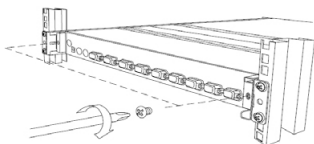

Connecting computers to the module

Attach each of your managed computers to your StarView KVM console's PC ports using StarTech.com KVM cables only. Use the KVM cables to connect one of the PC ports on the back of the switch to the computer's keyboard, mouse, and video ports. **Note:** These instructions are for a single KVM switch only.

Following this, plug the 12V DC power adapter into the power port on the KVM module, and turn on the computers that will be controlled by the console.

- * **Note:** After the initial power up, you can hot-plug additional computers or slave KVM switches without having to power down your KVM.

Cascade Configuration

You can connect a second level of KVMs to one or more of your Master KVM console's PC ports. The KVM switches connected to the Master console are known as Slaves. Once connected, the KVM switches will automatically configure themselves as either Masters or Slaves. You can only connect an equal or "smaller" KVM to the Master KVM. For example, a 16-port Master KVM switch can have both 16-port and 8-port slaves. An 8-port Master KVM switch can only have 8-port (or fewer) KVM slaves.

The 8-port KVM can support 64 PCs, with 8 x 8-port Slave KVMs, each connected to 8 PCs. The 16-port KVM can support 136 computers, with 8 16-port Slave KVMs, each connected to 16 computers. The Slave KVM's must be connected to the 1~8 ports, not the A~H ports.

To cascade your KVMs, use a StarTech.com KVM cable to connect one of your Master switch's PC ports to the Slave switch's console ports. When turning on your cascaded switches, turn on the Master switch before turning on any of the others.

Turning on the console

Make sure all cables and the power cord are connected properly. Using two hands, grasp the rear of the drawer, lift the tab and pull the panel up and forward. This will disengage the momentary on/off switch and the unit should power on.

The LED located to the left of the monitor panel should turn from orange to green, verifying that the unit is operational.

Configuring display settings

After connecting the drawer and turning on your computer, you may need to configure one or more of the following display settings to allow the computer to display at the console's native resolution. See Specifications on page 9 for the correct resolution mode for your model.

- Display mode (also called desktop area or video resolution)
- Refresh rate (also called vertical scan rate or vertical sync)
- Color depth (also called color palette or number of colors)

Each video card has several controls that allow you to adjust the display settings, however, the software and driver for each video card is unique. In most cases, you can adjust these settings using a program or utility provided by the manufacturer of the video card. Most video cards use the Windows Display Properties control panel to configure the display. To open the Windows Display Properties, click the right mouse button in a blank area of the Windows desktop and then select Properties. The Settings tab usually lets you change the Color Palette and the Desktop Area (X by Y pixel resolution).

Some video cards integrate additional features into the Windows Display Properties control panel giving you an extra setup options that are flexible and easy to use. For example, the control panel may include an Advanced Properties button, an Adjustment tab, or a Refresh tab for changing other settings. Other video cards have a separate utility for setting display properties.

Whenever you change the resolution, color, or refresh rate, the image size, position, or shape may change. This behavior is normal. You can readjust the image using the monitor on-screen controls. For more information on the monitor on-screen controls, refer to Panel controls and OSD functions. For more information on configuring the display settings, please refer to the manual that accompanied your video card.

Testing the console

To test that the console is working properly, perform the following steps:

1. Power up the LCD Rack Drawer, and then turn on your computer.
 2. Make sure the video image is centered within the screen area. Use the OSD controls to adjust the image (see Panel controls and OSD functions) or press the Auto button on the right hand side of the monitor.
- * **Note:** If the unit does not power up when the panel is pulled up, try pushing the soft power on/off button on the left side of the monitor panel to power up the unit.
 - * **Note:** You can adjust the horizontal and vertical position, contrast, and brightness to better suit your video card and your personal preference.

Before you begin, make sure that power to all of the devices you will be connecting to the console have been turned off. To prevent damage to your installation due to ground potential difference, make sure that all of the devices being installed are properly grounded. Once all peripherals have been connected, please power them on.

Panel controls and OSD functions

The following controls are located on the left side of the console monitor:

Controls	Descriptions
	Soft power on/off. Adjacent LED is lit when on.
Auto	Auto-synchronize and scale down display to any valid factory preset timings.
Up	Press to scroll to the function you want to adjust.
Down	Press to scroll to the function you want to adjust.
Menu	To access the main menu. This button also acts as the Enter button.

Auto tune

Press the “Auto tune” button. The panel will adjust the display size automatically and also tune the panel to its optimized state.

Input Source

1. Press the Menu button.
2. Use the Down and Up buttons to scroll.
3. Press the Menu button to enter, and you will see: VGA/DVI.
4. Use the Down and Up buttons to select the input signal source.
5. Press the Menu button to save your selection.

Brightness

1. Press the Menu button.
2. Use the Down and Up buttons to scroll to Brightness.
3. Press the Menu button to enter.
4. Use the Down and Up buttons to adjust the brightness of the display.
5. Press the Menu button to save your selection.

Contrast

1. Press the Menu button.
2. Use the Down and Up buttons to scroll to Contrast.
3. Press the Menu button to enter.
4. Use the Down and Up buttons to adjust the contrast of the display.
5. Press the Menu button to save your selection.

Color

1. Press the Menu button.
2. Use the Down and Up button to scroll.
3. Highlight Color, and press the Menu button to enter, which will launch the following screen:

Icon	Description
9300°K	To set CIE coordinates at 9300°K color
7500°K	To set CIE coordinates at 7500°K color
6500°K	To set CIE coordinates at 6500°K color
User	To set user defined CIE
Auto color	To auto adjust color
Return	To exit and return to the previous page

4. Use the Down and Up buttons to adjust the contrast of the display.
5. Press the Menu button to save your selection.

Position

1. Press the Menu button.
2. Use the Down and Up buttons to scroll.
3. Highlight Position and press the Menu button to enter, which will launch the following screen:

Icon	Description
Image Pos	To adjust the position of the image
OSD Pos	To adjust the position of the OSD
Return	To exit and return to the previous page

4. Use the Down and Up buttons to scroll.
5. Press the Menu button to save your selection.

Language

1. Press the Menu button.
2. Use the Down and Up buttons to scroll.
3. Highlight Language, and press the Menu button to select, which will launch the following screen:

English	←
German	
French	
Italian	
Spanish	

4. Use the Down and Up buttons to scroll, and highlight the preferred language.
5. Press the Menu button to save your selection.

Recall

1. Press the Menu button.
2. Use the Down and Up buttons to scroll to Recall. Press the Menu button to enter, where you will be able to select Yes/No using the Down and Up buttons. Once you have done so, press the Menu button. Note: selecting Yes will return your settings to the factory default state. Select No if you do not wish to make this change.

Exit

To exit the menu, scroll to Exit and press the Menu button.

Power Indicator

Light Color	Status
Green	ON
RED	Standby
RED	Suspend
RED	OFF

Module operation

OSD Selection

A computer may be selected by issuing hot-key commands or by activating the OSD window. The **Auto-Scan** function automatically scrolls through your connected computers.

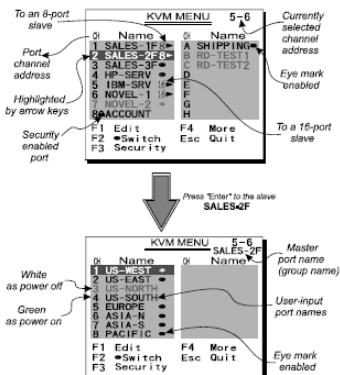

By hitting the left **<CTRL>** key twice within two seconds, you may see the Hotkey Menu (if it is enabled as an OSD option). Or, by hitting the left **<CTRL>** key three times within two seconds, you will see a KVM MENU screen (below) showing a list of the computers with corresponding channel addresses, names and status.

The port number of the currently selected computer is displayed in red, at the right corner of the OSD menu.

The color of a device name is green if it has power and is ready for operation, or the color is white if it has no power. The OSD menu updates the color when it is activated.

Use the **<↑>** and **<↓>** arrow keys to highlight a computer and the **<ENTER>** key to select it. Or, you may press **<ESCAPE>** to exit the OSD and remove the OSD menu from the display; the status window returns to the display and indicates the currently selected computer or operating status.

A triangle mark to the right of a name indicates the port is cascaded to a Slave; the number at the left of the triangle mark shows the number of ports the Slave has, i.e. 8 for an 8-port switch. The **<ENTER>** key brings you one level down and another screen pops up listing the names of the computers on that Slave. The name of the Slave will be shown at the upper right corner of the OSD menu. It is useful to group computers and still be able to see the group name.

An eye mark (👁) to the right of a name indicates the computer is selected to be monitored in Scan mode. In OSD, this mark can be switched on or off by function key **<F2>**. Press the **<ESCAPE>** key to exit OSD and to return to the selected computer; the computer name is also shown on the screen.

Editing Computer Name Assignments

Function key <F1> - To edit the name entry of a computer or a Slave, first use the **<↑>** and **<↓>** arrow keys to highlight a port then press **<F1>** followed by name entry. Valid characters are 'A'~'Z', '0'~'9' and the dash (-) character. Lowercase letters are converted to uppercase ones. Press **<BACKSPACE>** to delete one letter at a time. Non-volatile memory stores all name entries until you change, even if the unit is powered down.

Selecting Computers for Autoscan

Function key <F2> - Use this key to switch the eye mark (👁) of a computer on or off. First, use the <↑> and <↓> arrow keys to highlight it, then press <F2> to switch its eye mark on or off. If Scan Type reads 'Ready PC + 👁', only the power-on and eye mark selected computers will be displayed sequentially in Scan mode.

Locking Devices (Slave or computer

Function key <F3> - To lock a device (a computer or a Slave) from unauthorized access, use Security. Security is effective for only one device (a computer or a Slave). To lock a device, use the <↑> and <↓> arrow keys to highlight it, then press <F3>. Now, enter up to 4 characters ('A'~'Z', '0'~'9', '-') followed by <ENTER> as new password. A Security enabled device is marked with a lock (🔒) following its port number. To permanently disable the security function from a locked device, highlight it, press <F3> then enter the password.

If you want to access the locked device temporarily, simply highlight it and press <ENTER>. The OSD will prompt for the password. After entering the correct password, you are allowed to use the device. This device is automatically re-locked once you switch to another one. During Scan mode, OSD skips the security-enabled device. Note: Only one device (a computer or a Slave) can be locked by this function at a time.

Please note: If you forget the password, the only way to permanently disable the security function is to remove all possible power sources from the Console. You will need to turn off all computers and unplug all power adapters, then restart everything.

Advanced Functions

Function key <F4> - More functions are available by hitting <F4>. A new screen pops up displaying more functions as described below. Most of them are marked with a triangle (<▲>) indicating there are options to choose from. Using the <↑> and <↓> arrow keys, select the functions and press <ENTER>. Available options will be shown in the middle of the screen. Again, using the <↑> and <↓> arrow keys to view options, then press <ENTER> to select it. You can press <ESCAPE> to exit at any time.

Auto Scan

In this mode, the Console automatically switches from one powered computer to the next, sequentially in a fixed interval. During Auto Scan mode, the OSD displays the name of the selected computer. When Auto Scan detects any keyboard or mouse activity, it suspends the scanning until activity stops; it then resumes with the next computer in sequence. To abort Auto Scan mode, press the left <CTRL> twice, or, press any front button. Scan Type and Scan Rate set the scan pattern. Scan Type (<F4>:More\Scan Type) determines if scanned computers must also be eye mark selected. Scan Rate (<F4>:More\Scan Rate) sets the display interval when a computer is selected before selecting the next one.

Manual Scan

Scan through power-on computers one by one by keyboard control. Scan Type (<F4>:More\Scan Type) determines if scanned computers must also be eye mark selected. Press the <↑> key to select the previous computer and the down arrow key to select the next computer. Press any other key to abort Manual Scan mode.

Audio Stick

An optional multimedia module can be linked to the back of each KVM Module for selecting microphone and stereo speaker signals. There are two options for Audio Stick: On and Off. When set to On, audio selection follows computer selection. When set to Off, audio selection stops following computer selection. It is useful if you want to listen to a particular computer's audio signal while operating other computers. The non-volatile memory stores the Audio Stick setting.

Scan Type

Ready PC + : In Scan mode, scan through power-on and eye mark selected computers. Ready PC: In Scan mode, scan through power-on computers. The non-volatile memory stores the Scan Type setting.

Scan Rate

Sets the duration of a computer displayed in Auto Scan mode. The options are 3 seconds, 8 seconds, 15 seconds and 30 seconds. The non-volatile memory stores the Scan Rate setting.

Keyboard Speed

The Console offers keyboard typematic settings that override similar settings in the BIOS and in Windows. Available speed options are Low, Middle, Fast and Faster as 10, 15, 20 and 30 characters/sec respectively. The non-volatile memory stores the Keyboard Speed setting.

Hotkey Menu

When you hit the left <CTRL> key twice within two seconds, the Hotkey Menu appears displaying a list of hot-key commands if the option is On. The Hotkey Menu can be turned Off if you prefer not to see it when the left <CTRL> key is hit twice. The non-volatile memory stores the Hotkey Menu setting.

CH Display

Auto Off: After you select a computer, the port number and name of the computer will appear on the screen for 3 seconds then disappear automatically. Always On: The port number and name of a selected computer and/or OSD status are displayed on the screen all the time. The non-volatile memory stores the CH Display setting.

Position

The position of the selected computer name and/or OSD status displayed on screen during operation. The actual display position shifts due to different VGA resolution, the higher the resolution the higher the display position. The nonvolatile memory stores the Position setting. UL as Upper Left, UR as Upper Right, LL as Lower Left, LR as Lower Right. MI as Middle.

Hot-key commands

A Hot-key command is a short keyboard sequence used to select a computer, to activate computer scan, etc. The Console constantly interprets keystrokes for hot-keys. A hot-key sequence starts with two left <CTRL> keystrokes followed by one or two more keystrokes. A built-in alarm generates a high-pitch beep for correct hot-key command; otherwise, one low-pitch beep for error and the bad key

sequence will not be forwarded to the selected computer.

The short form hot-key menu can be turned on as an OSD function (<F4>: more\Hotkey Menu) every time the left <CTRL> key is pressed twice.

L-CTRL: is the <CTRL> key located at the left side of the keyboard.

1~8/A~H: are the number keys '1' ~ '8' at the upper row of the keyboard and character keys 'A' ~ 'H' case insensitive. Do not use the keypad at the right of the keyboard.

To select a computer by hot-key command, you must know its port number, which is determined by the KVM Module connection. For a computer connected to a Master, its port is represented by the PC port label (1~8 or A~H). For a computer connected to a Slave, two characters represent its port. The first character is the port number of the Master unit (1~8) and the second one is the port number of the Slave (1~8 or A~H). Please note that only Master's 'PC 1' ~ 'PC 8' ports can be connected to a Slave.

Left Ctrl + left Ctrl + 7

Selects a computer connected to port 7 of the Master.

Left Ctrl + left Ctrl + 6 + C

Selects a computer connected to port C of a Slave connected to port 6 of the Master.

To start Auto Scan, automatically scan power-on computers one by one at a fixed interval:

Left Ctrl + left Ctrl + F 1

When Auto Scan detects any keyboard or mouse activity, it suspends the scanning till activity stops; it then resumes with the next computer in sequence. The length of the Auto Scan interval (Scan Rate) is adjustable, see below. To abort the Auto Scan mode, press the left Ctrl key twice.

* Note: Scan Type determines whether an eye-marked computer is to be displayed during Auto Scan.

Manual Scan enables you to manually switch back and forth between power-on computers.

Left Ctrl + left Ctrl + F2

Press <↑> or <↓> to select the previous or the next computer in sequence. Press any other key to abort the Manual Scan.

* Note: Scan Type determines whether an eye-marked computer is to be displayed during Auto Scan.

To adjust Scan Rate which sets the duration before switching to the next computer in Auto Scan:

Left Ctrl + left Ctrl + F3

The Rack Console sends one to four beeps indicating scan interval of 3, 8, 15 and 30 seconds respectively. To adjust keyboard typematic rate (characters/sec), this setting over-rides that of BIOS and any operating system:

Left Ctrl + left Ctrl + F4

The Rack Console will generate 1 to 4 beeps corresponding to 10, 15, 20 and 30 characters/sec respectively.

Change Configuration while Running

A device (a computer or a KVM switch) at any 'PC x' port can be changed at any time after initial power-up. If you change any one of the PC 1 to PC 8 ports connection from a computer to a Slave or vice versa, or replace the devices of a port, the OSD will update this change the next time it is activated.

* Note: Any new device must be turned off before it is connected to the Master.

Specifications

	RACKCONU1708 RKCONU1708GB/EU RACKCONU1716 RKCONU1716GB/EU	RACKCONU1908 RKCONU1908GB/EU RACKCONU1916 RKCONU1908GB/EU
Display Size	17"	19"
Connectors	8 x DE-15 female input (1708) or 16 x DE-15 female input (1716) 1 x VGA female output inactive: 2 x USB type A (keyboard/mouse)	8 x DE-15 female input (1908) or 16 x DE-15 female input (1916) 1 x VGA female output inactive: 2 x USB type A (keyboard/mouse)
Panel Type	Active Matrix TFT LCD	
Resolution Capabilities	1280 x 1024 (XGA)	
Pixel Pitch	0.264mm x 0.264mm	0.098mm x 0.294mm
Back Light	Four lamps	
Viewing Angle (Typ)	Right-Left view: 60~70 Up-Down View: 45~60	Right-Left view: 140 Up-Down View: 140
Contrast Ratio	450:1	500:1
Brightness	White 250cd/m2 (Center 1 point Typ)	
Supported Colors	16.2M Colors (6-bit with FRC)	
Response Time	Rising Time: 2ms Decay Time: 14ms	Rising Time: 2ms Decay Time: 10ms
Keyboard / Mouse	106 key USB keyboard with touchpad	
Keyboard Language	USA, UK, German, French, Spanish, Italian, Portuguese, Dutch, Swiss, Belgium, Swedish, Norwegian, Danish, Japan, Taiwan, Russian	
Sync	45~80KHz	
Power Source	100-240 VAC input	
Power Adapter	12VDC, 4A	

	RACKCONU1708 RKCONU1708GB/EU RACKCONU1716 RKCONU1716GB/EU	RACKCONU1908 RKCONU1908GB/EU RACKCONU1916 RKCONU1908GB/EU
Power Consumption	19.05W for Panel	21.05W for Panel
Humidity	10% ~ 90% RH	
Dimensions	440 x 470 x 44mm	490 x 470 x 44mm
Net Weight	11.00kg (1708) 12.00kg (1716)	11.00kg (1908) 12.00kg (1916)
Chassis Construction	Heavy duty steel	
Regulatory Certification	CE, FCC, UL, CUL, CE, RoHS	

Technical Support

StarTech.com's lifetime technical support is an integral part of our commitment to provide industry-leading solutions. If you ever need help with your product, visit www.startech.com/support and access our comprehensive selection of online tools, documentation, and downloads.

Warranty Information

This product is backed by a one year warranty.

In addition, StarTech.com warrants its products against defects in materials and workmanship for the periods noted, following the initial date of purchase. During this period, the products may be returned for repair, or replacement with equivalent products at our discretion. The warranty covers parts and labor costs only. StarTech.com does not warrant its products from defects or damages arising from misuse, abuse, alteration, or normal wear and tear.

Limitation of Liability

In no event shall the liability of StarTech.com Ltd. and StarTech.com USA LLP (or their officers, directors, employees or agents) for any damages (whether direct or indirect, special, punitive, incidental, consequential, or otherwise), loss of profits, loss of business, or any pecuniary loss, arising out of or related to the use of the product exceed the actual price paid for the product. Some states do not allow the exclusion or limitation of incidental or consequential damages. If such laws apply, the limitations or exclusions contained in this statement may not apply to you.



StarTech.com has been making “hard-to-find easy” since 1985, providing high quality solutions to a diverse IT and A/V customer base that spans many channels, including government, education and industrial facilities to name just a few. We offer an unmatched selection of computer parts, cables, A/V products, KVM and Server Management solutions, serving a worldwide market through our locations in the United States, Canada, the United Kingdom and Taiwan.

Visit **www.startech.com** today for complete information about all our products and to access exclusive interactive tools such as the Cable Finder, Parts Finder and the KVM Reference Guide.