

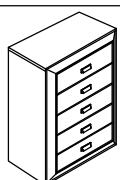

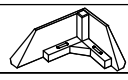

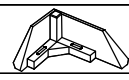

## ASSEMBLY INSTRUCTION / INSTRUCTIONS DE MONTAGE

Thanks you for purchasing this product. Please take time to read and follow the instructions below. Check that you have all parts and hardware before assembly. Parts apparently missing are often found in the packing materials. If you do not have the parts listed, call us and they will be sent to you immediately.

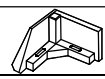
Merci d'avoir acheté ce produit. Veuillez lire et suivre les instructions ci-dessous. Vérifiez avant le montage que vous avez toutes les pièces et fixations. Les pièces qui semblent manquer se trouvent dans les matériaux d'emballage. Si vous n'avez pas toutes les pièces de la liste, appelez-nous et nous vous les enverrons immédiatement.

NO	PARTS LIST / LISTE DE PIÈCES			STEP 1 / ETAPE 1 Take out Assembly Instruction sheet, Hardware Pack and Feet Packaging from the Drawer which marked with the rope.
A	Chest Commode		1	
B	Front Right Feet Pieds Avant Droite		1	
C	Front Left Feet Pieds Avant Gauche		1	
D	Rear Right Feet Pieds Arrière Droite		1	
E	Rear Left Feet Pieds Arrière Gauche		1	
NO	HARDWARE LIST / LISTE DE QUINCAILLERIE			
F	Bolt / Boulon 35mm		8	
G	SpringWasher / Rondelle de ressort		8	
H	Washer / Rondelle Plate Ø4" x 20mm		8	
I	Allen Key / Clé Allen M4		1	

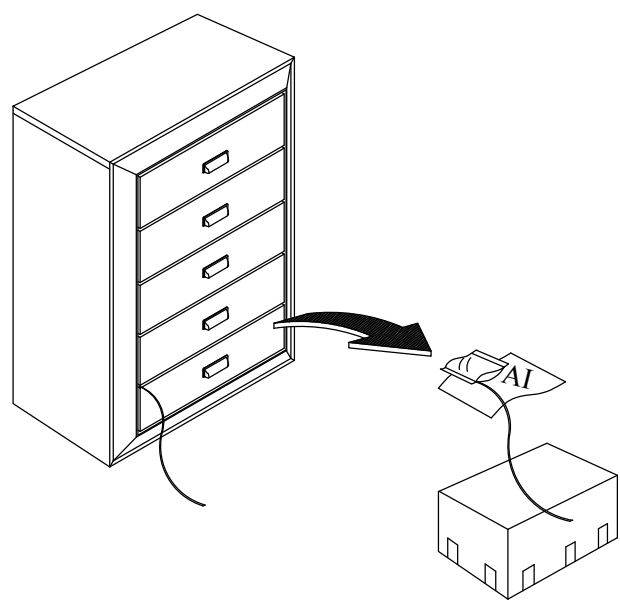

"FR" & "FL" Marking at bottom of the Unit & top of the Leg

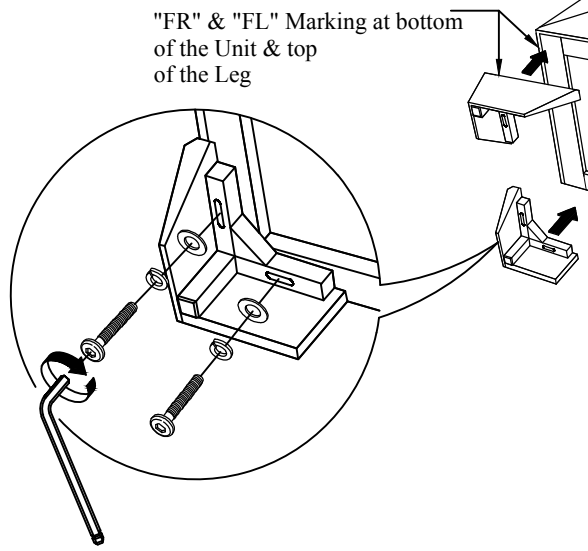



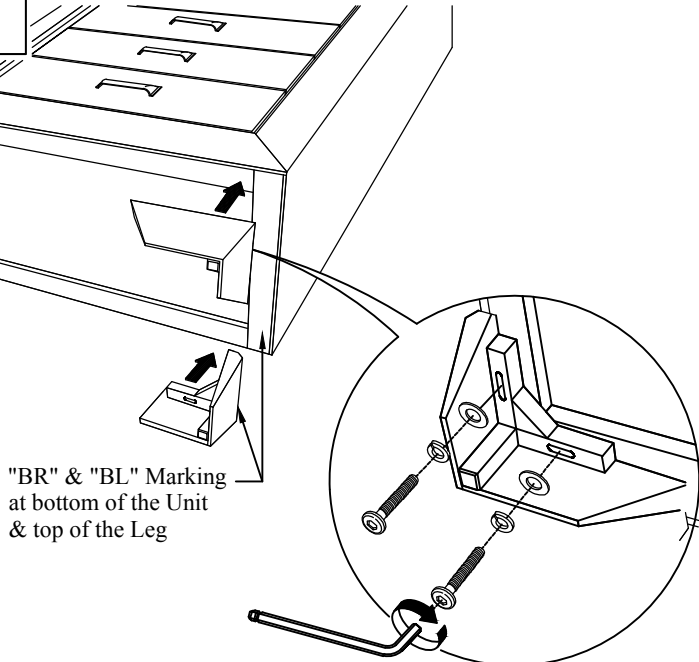

"BR" & "BL" Marking at bottom of the Unit & top of the Leg



**STEP 2 / ETAPE 2**  
Align & tighten feet (B),(C),(D) and (E) to Unit according to the position left and right. follow the label correctly using bolt (F), lock washer (G) and flat washer (H) and fully tighten with Allen Key (I).

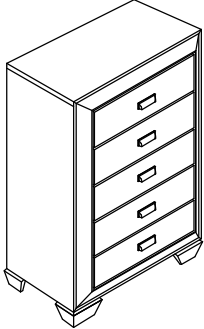

**For items use on wooden floor, hard surfaces or carpets, it is recommended to Install protective pads under all legs and supports to avoid/prevent from damages/scratches and discoloration.**

PARTS IDENTIFICATION IDENTIFICATION DES PIÈCES		HARDWARE IDENTIFICATION IDENTIFICATION DE LA QUINCAILLERIE			
A. CHEST COMMODORE 	1 SET 1 ENSEMBLE	1.		16MM SCREW VIS COURTE	1 PC. 1 PCE.
		2.		50MM SCREW VIS LONGUE	1 PC. 1 PCE.
		3.		TIE STRAP COURROIE	1 PC. 1 PCE.
		4.		L BRACKET ÉQUERRE	2 PCS. 2 PCES.

This tip restraint must be attached to a wall stud using 50mm screw enclosed.

### STEP 1 / Etape 1

Attach the bracket securely to the back top rail of the chest using 16mm screw provided, through the smaller hole.

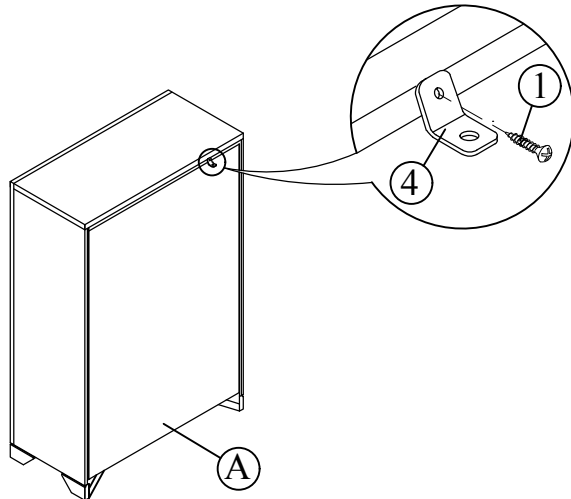

### STEP 2 / Etape 2

Locate the other bracket on the wall over a wall stud and two inches below the mounting bracket secured to the back of chest. Attached to the wall stud using the 50mm screw provided, through the smaller hole.

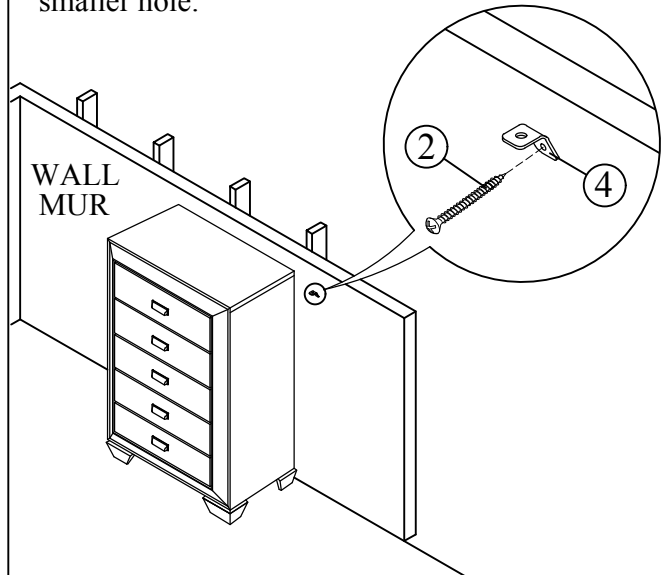

### STEP 3 / Etape 3

Place the chest into position so both mounting brackets are vertically in line. Pull the end of the restraint strap through the larger hole in each mounting bracket. Bring both ends together and slide the flat end through the locking end and draw it through until all slack is removed. Check that the strap is securely laced and locked.

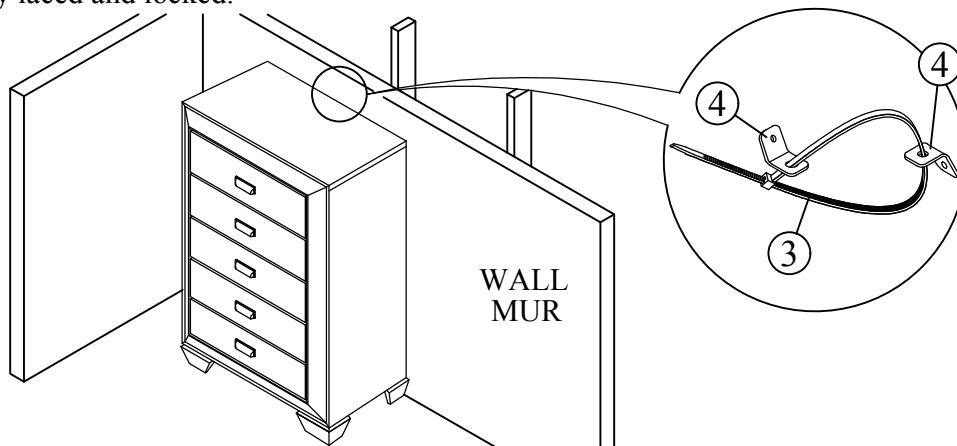

For items use on wooden floor, hard surfaces or carpets, it is recommended to Install protective pads under all legs and supports to avoid/prevent from damages/scratches and discoloration.