

Features

- Includes lever handle, single-function showerhead, shower arm and flange, valve trim, and nondiverter bathtub spout with NPT or slip-fit connection
- Single lever handle allows for both on/off activation and temperature setting
- Rite-Temp® pressure-balancing technology maintains water temperature within +/- 3°F
- Integrated push-button diverter
- Includes single-function 2.5 gpm (9.5 lpm) showerhead with Katalyst® air-induction technology

Material

- Premium material construction for durability and reliability
- KOHLER finishes resist corrosion and tarnishing

Installation

- Trim only; requires K-11748-K or K-11748-KS Rite-Temp pressure-balancing valve (sold separately)

Required Products/Accessories

K-11748 Series Rite-Temp® Valves

Adapters, Rough-in and Extension Kits

1226074-CP

Range: 4-1/2" (115 mm) -
5-13/16" (148 mm)

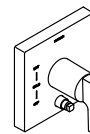
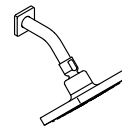

Codes/Standards





ASME A112.18.1/CSA B125.1
DOE - Energy Policy Act 1992
NOM Standards
NOM 008-CONAGUA

KOHLER® Faucet Lifetime Limited Warranty

See website for detailed warranty information.

Available Colors/Finishes

Color tiles intended for reference only.

Color	Code	Description
	CP	Polished Chrome
	BN	Vibrant® Brushed Nickel
	BL	Matte Black
	2MB	Vibrant® Brushed Moderne Brass

Slip-fit Spout:

Extend 5/8" OD Tube
 5-9/16" (141 mm) from finished wall

Threaded Spout:

Extend 5/8" OD Tube
 5-9/16" (141 mm) from finished wall

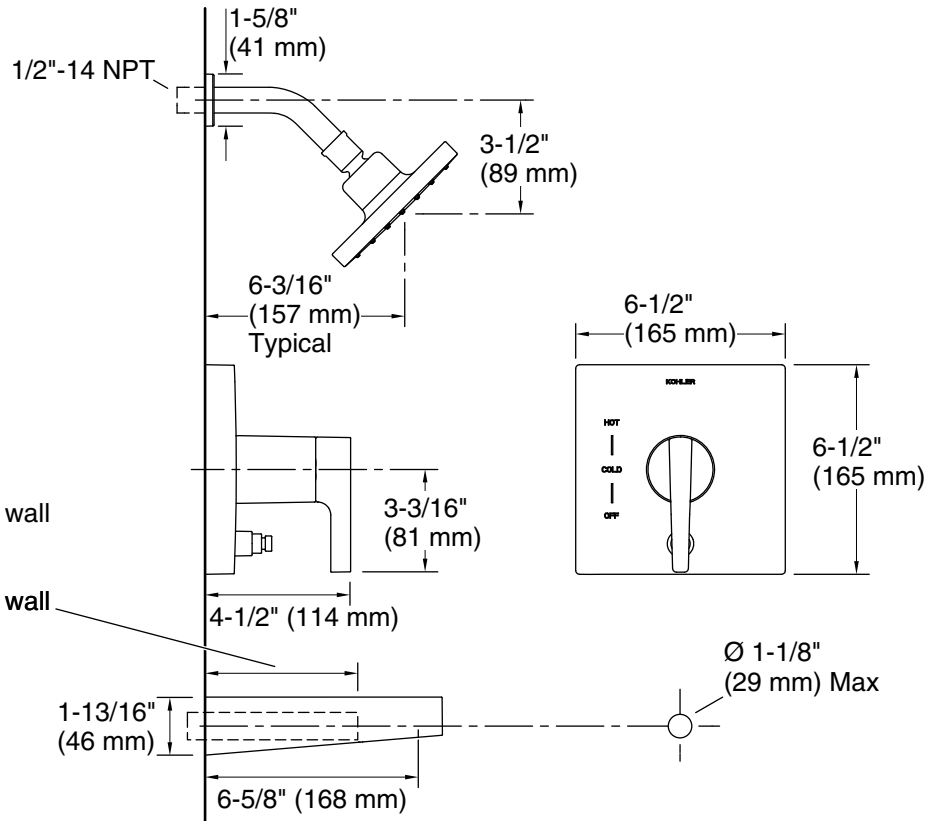

Technical Information

All product dimensions are nominal.

Spout:

Shower/Rainhead rated max flow: 2.5 gal/min (9.5 l/min)

Notes

Install this product according to the installation guide.

Install straight pipe or tube drop of 7" (178 mm) to 18" (457 mm) with single elbow between the valve and the wall-mount spout. Elbow must be a 90 degree drop ell that is secured to rigid framing.