

65411B Tucson Container Loading

(1 set=3 boxes, 180 sets/40HQ, 20 pallets/ 40HQ)

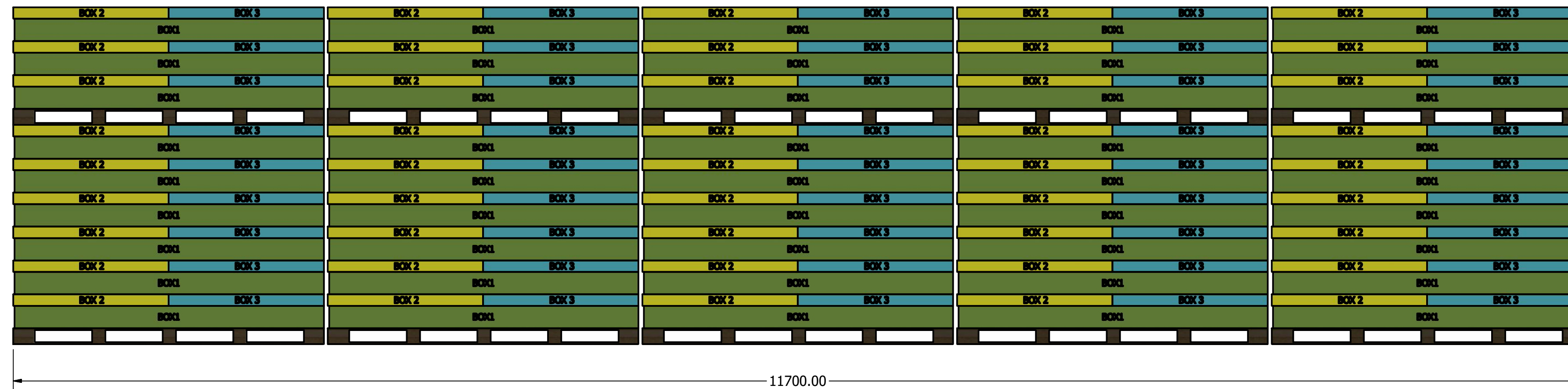
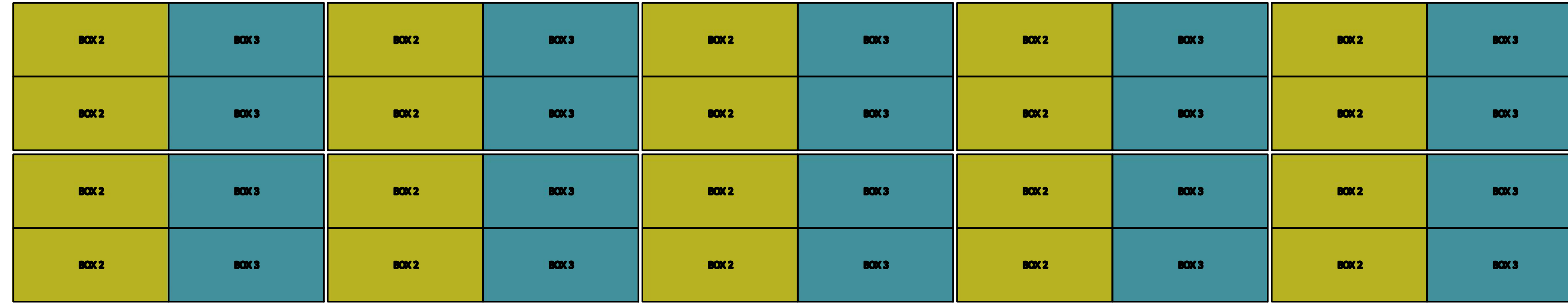
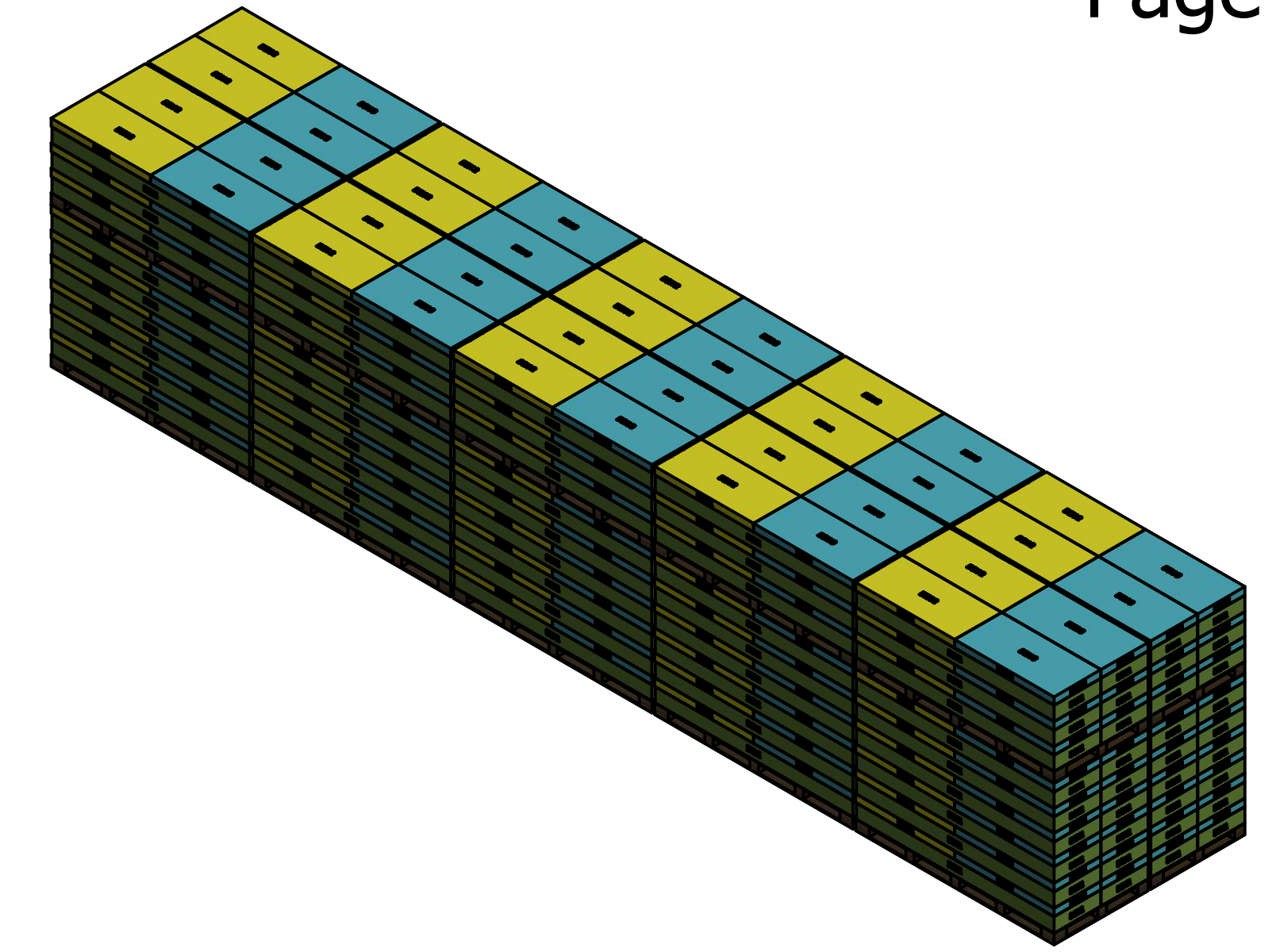

Pallet B * 10

Pallet A * 10

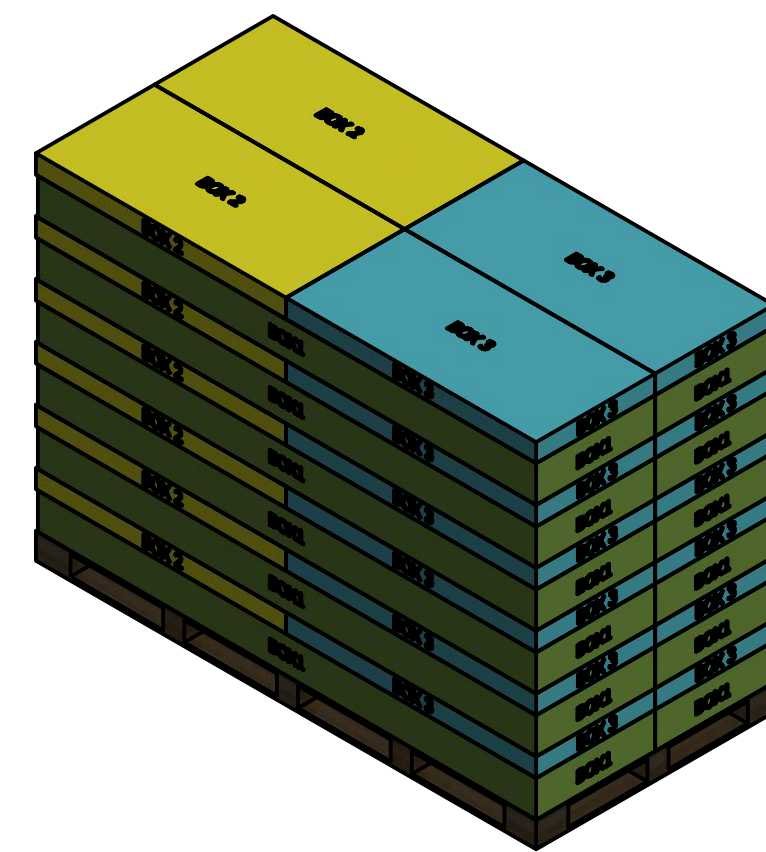
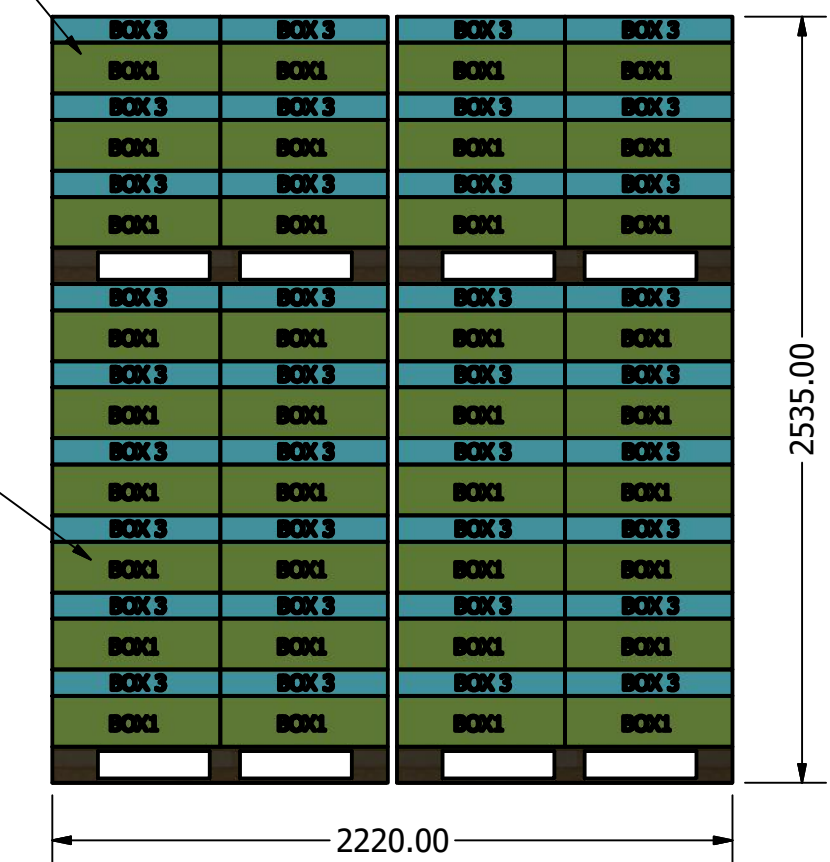

Pallet A (12 sets/Pallet)

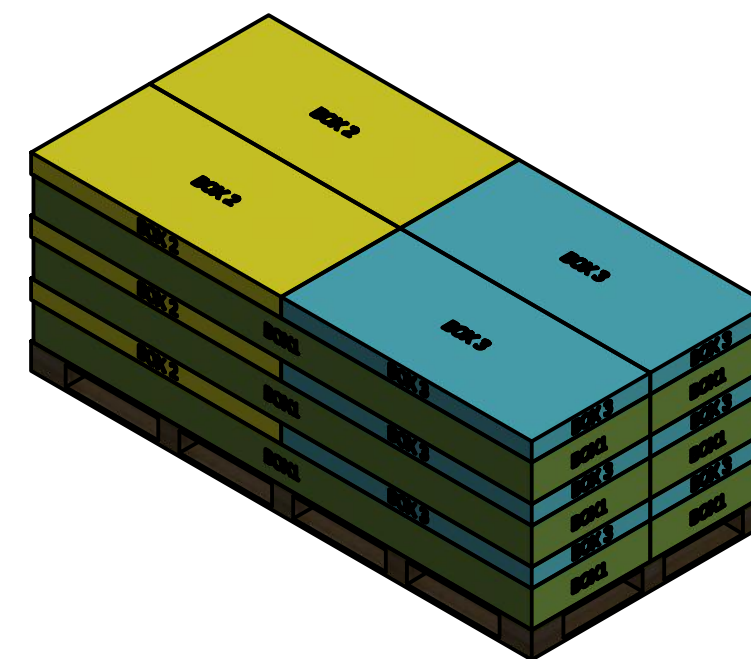

Pallet B (6 sets/Pallet)

DRAWN Rudy		TITLE	
CHECKED			
QA			
MFG			
APPROVED			
		SIZE D	DWG NO 65411B TUCSON
		SCALE 1 / 25	REV
		SHEET 1 OF 1	

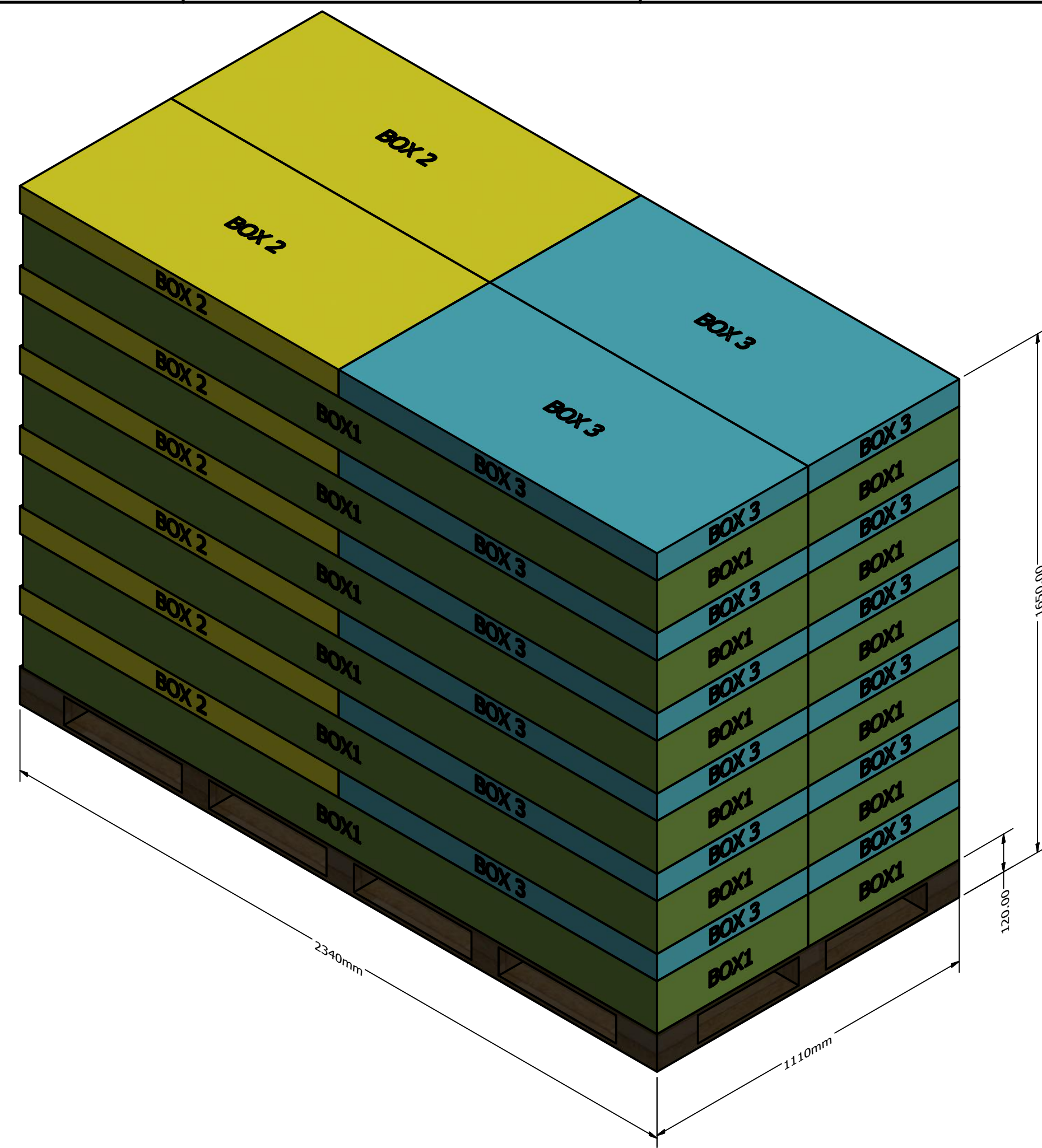

Pallet A detail (12 sets/40HQ)

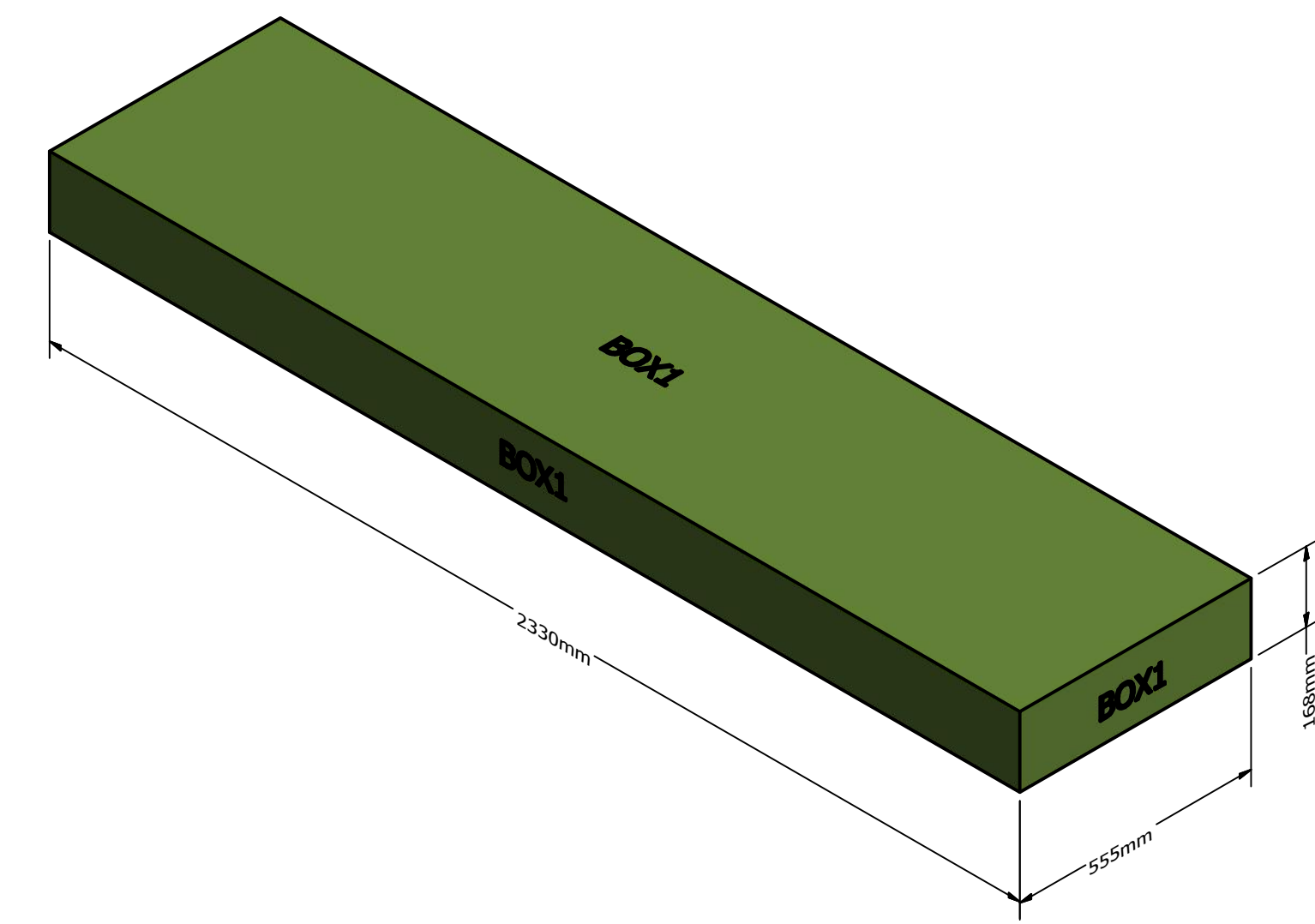

Box1 (61kg)

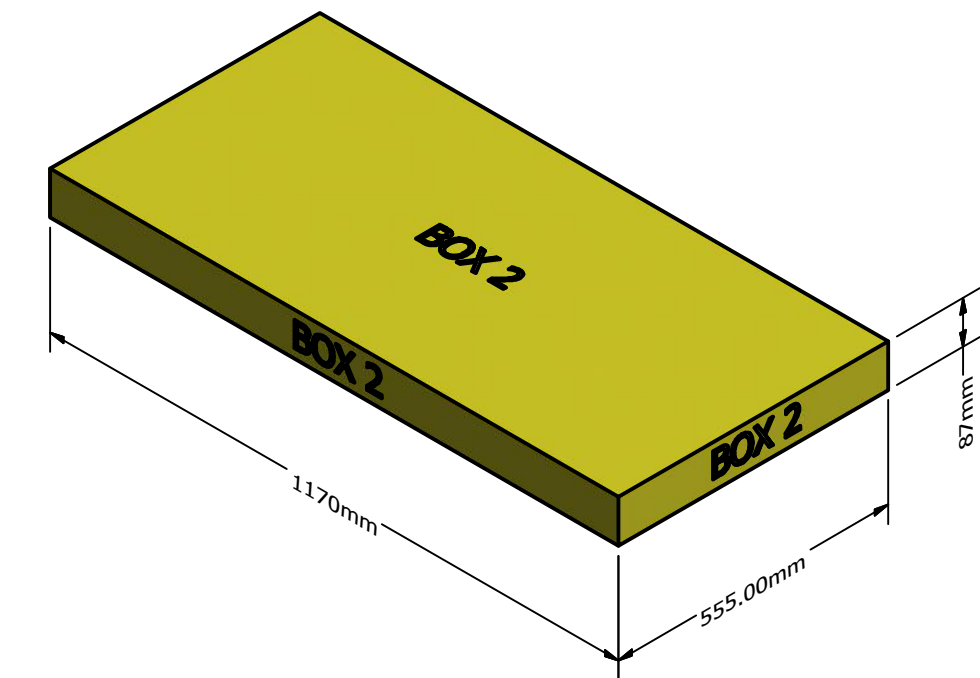

Box2 (17kg)

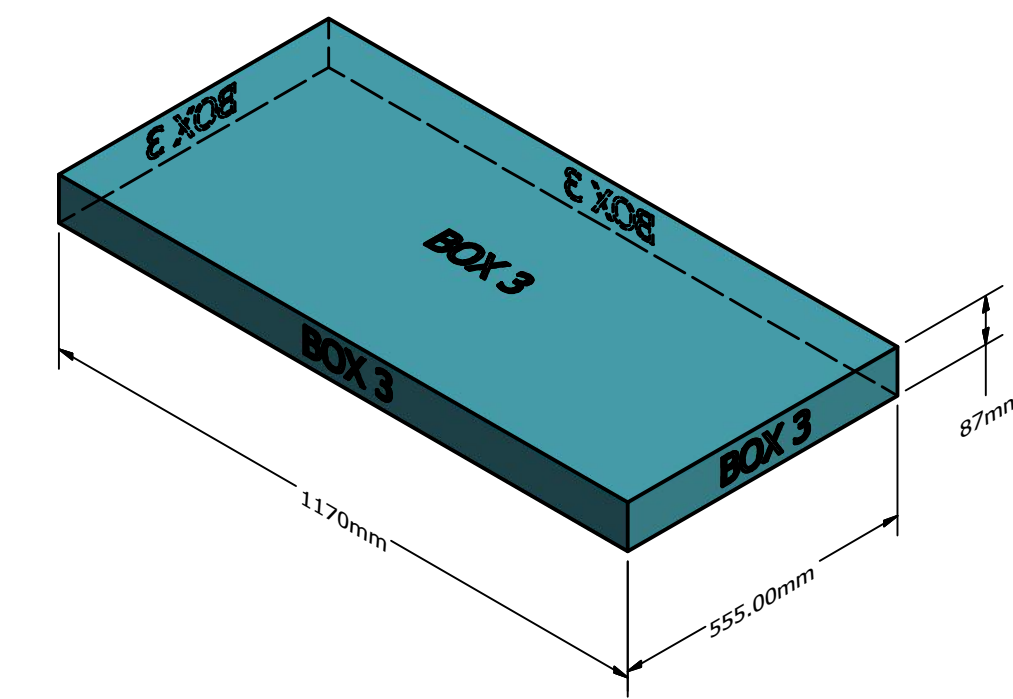

Box3 (19kg)

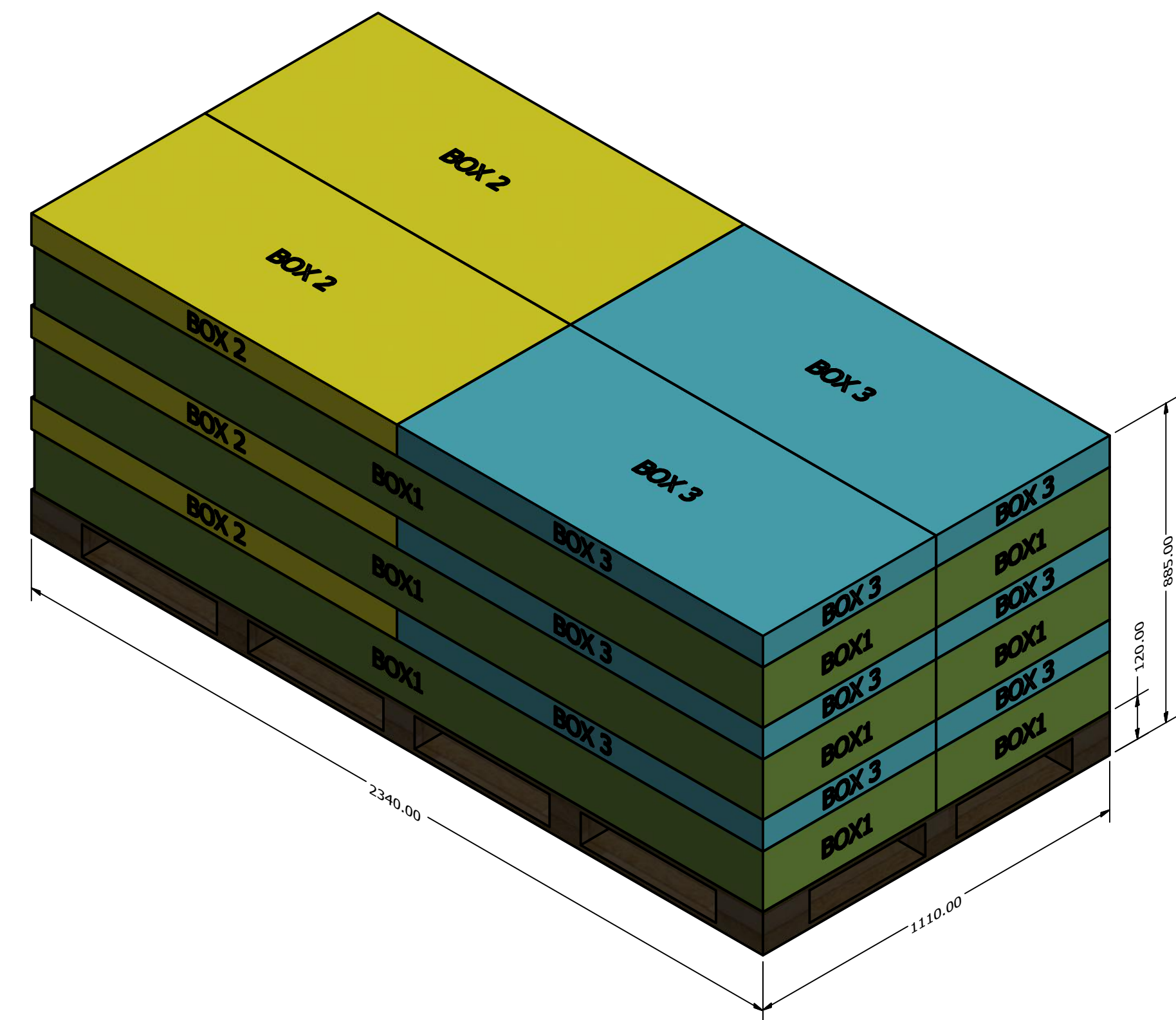

Pallet B detail (6 sets/40HQ)

DRAWN Rudy		TITLE	
CHECKED			
QA			
MFG			
APPROVED			
		SIZE D	DWG NO Pallet A
		SCALE 1:11	REV SHEET 1 OF 1