

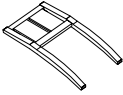

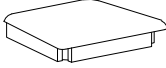









# ASSEMBLY INSTRUCTION

## COUNTER HEIGHT CHAIR

<b>A</b> Chair Back 1 pc 	<b>B</b> Chair Seat 1 pc 	<b>C</b> Left Leg 1 pc 	<b>D</b> Right Leg 1 pc 
<b>E</b> Front Stretcher 1 pc 	<b>F</b> Left Stretcher 1 pc 	<b>G</b> Right Stretcher 1 pc 	<b>H</b> Lock Washer 1/4" 1 pc 
<b>I</b> Flat Washer 1/4" 1 pc 	<b>J</b> Bolt 1/4"*1-1/2" 1 pc 	<b>K</b> Bolt 1/4"*2-3/8" 1 pc 	<b>L</b> Bolt 1/4"*3-1/4" 10 pcs 
<b>M</b> Wood Screw #8*1-1/2" 10 pcs 	<b>N</b> Allen Wrench 4mm 2 pcs 	4 pcs	4 pcs
6 pcs	1 pc		

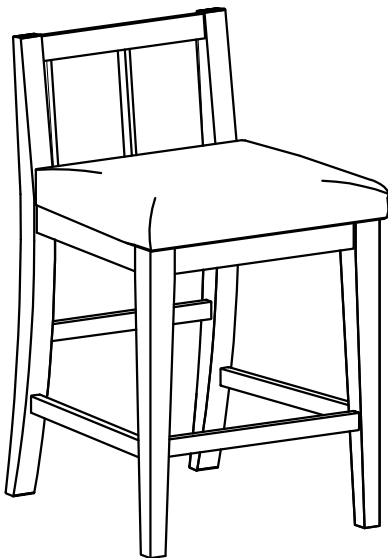

This page lists all the contents included in the box. Please take the time to identify the hardware as well as the individual components to this product. As you unpack and prepare for assembly, place the contents on a carpeted or padded area to protect them from damage.

**1**

Place the Chair Back (A) on the smooth carpeted surface. Attach the Chair Seat (B) to Chair Back (A) by Bolt (L), Bolt (J), Lock Washer (H), Flat Washer (I) with Allen Wrench (N).

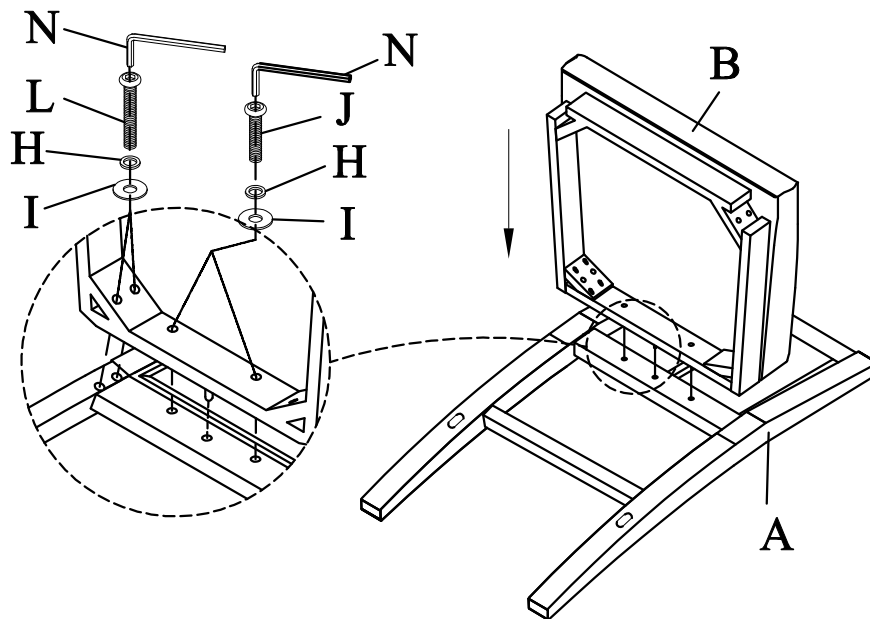
**2**

(1) Attach Left Stretcher (F) & Right Stretcher (G) to Chair Back (A). Then attach Left Leg (C) & Right Leg (D) to Left Stretcher (F) & Right Stretcher (G).

(2) Attach Front Stretcher (E) to Left Leg (C) & Right Leg (D).

(3) Attach Left Leg (C) & Right Leg (D) to Chair Seat (B), secure with Bolt (K), Lock Washer (H), Flat Washer (I) and tighten with Allen Wrench (N).

(4) Insert Wood Screw (M) to the holes at Front Stretcher (E), Left Stretcher (F) & Right Stretcher (G) and tighten all screws using Philips Head Screwdriver (not provide).

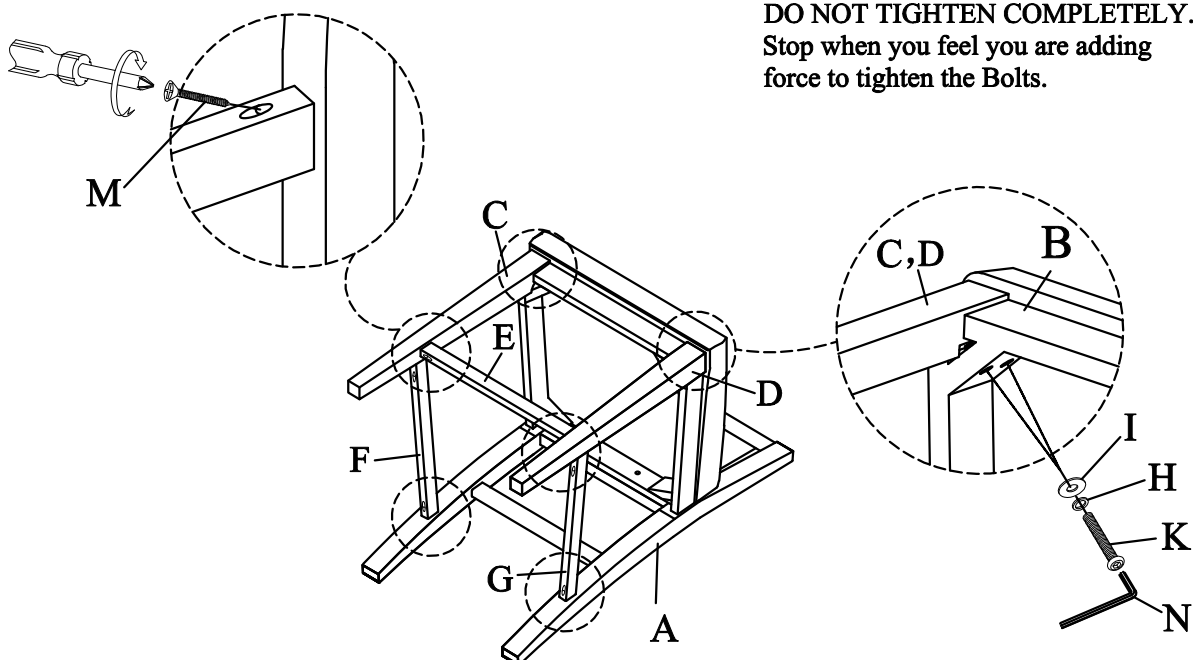

Take the Allen Wrench (N), and turn the Bolts until the legs are secured. **DO NOT TIGHTEN COMPLETELY.** Stop when you feel you are adding force to tighten the Bolts.

---

**3**

Assembly is completed.

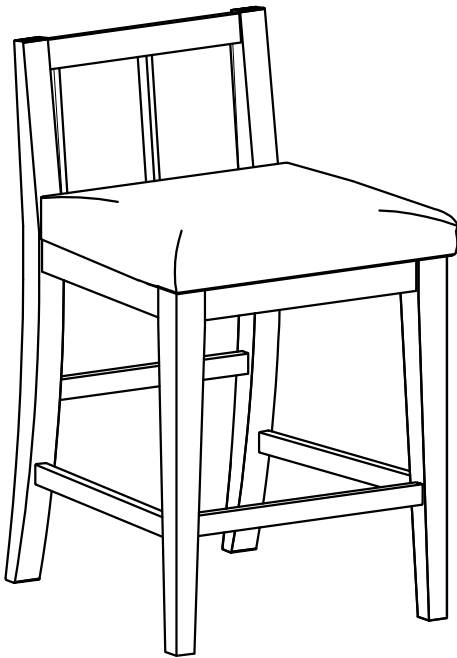

Stand chair up on an even surface and check that it is balanced. If there is a slight wobble, apply downward pressure in the corner where a leg is uneven. Keeping pressure in that corner, tighten all Bolts. If balanced, apply downward pressure evenly in the center and tighten all Bolts. Do not over-tighten beyond hole depth.

**Helpful Tip:**

-Instead of applying downward pressure while reaching under to tighten bolts, have someone sit on the chair while you tighten the Bolts.

---

**Cleaning & Care**

Treat surface with care. Surface is resistant to scratches but is not scratch resistant. Clean surfaces with a dry or damp soft cloth. Do not use abrasive cleaners. Hardware may loosen over time. Periodically check that all connections are tight.