

ASSEMBLY INSTRUCTION

DRESSER

A Dresser

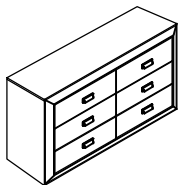

1 pc

B Front Right Feet (FR)

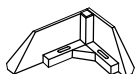

1 pc

C Front Left Feet (FL)

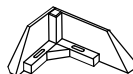

1 pc

D Rear Right Feet (BR)

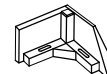

1 pc

E Rear Left Feet (BL)

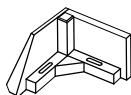

1 pc

F Support Leg

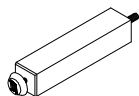

1 pc

G JCBC Bolt M6 x 35mm



8 pcs

H Spring Washer Ø1/4"



8 pcs

I Flat Washer Ø1/4" x 20mm



8 pcs

J Allen Key M4 x 65mm



1 pc

K Anti-Tipping Kit



1 set

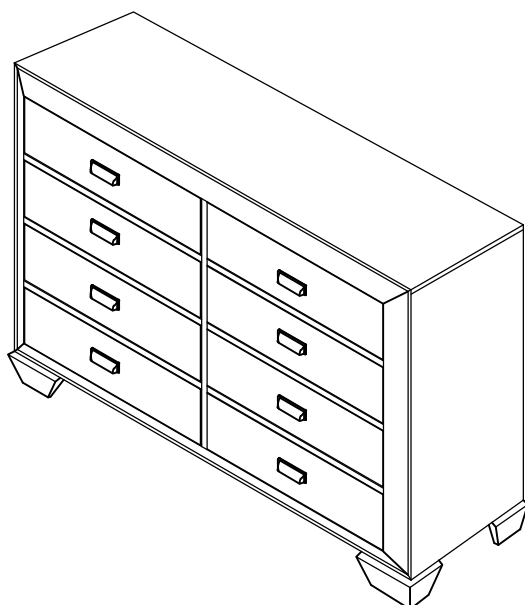

This page lists all the contents included in the box. Please take the time to identify the hardware as well as the individual components to this product. As you unpack and prepare for assembly, place the contents on a carpeted or padded area to protect them from damage.

IMPORTANT NOTE :

1. Do not tighten all screws / bolts until all completely assembled.
2. Keep all hardware parts out reach of children.

1

Take out Hardware Pack with Feet Packaging from the bottom of Dresser which marked with the rope while Assembly Instruction sheet is placed at 1st drawer.

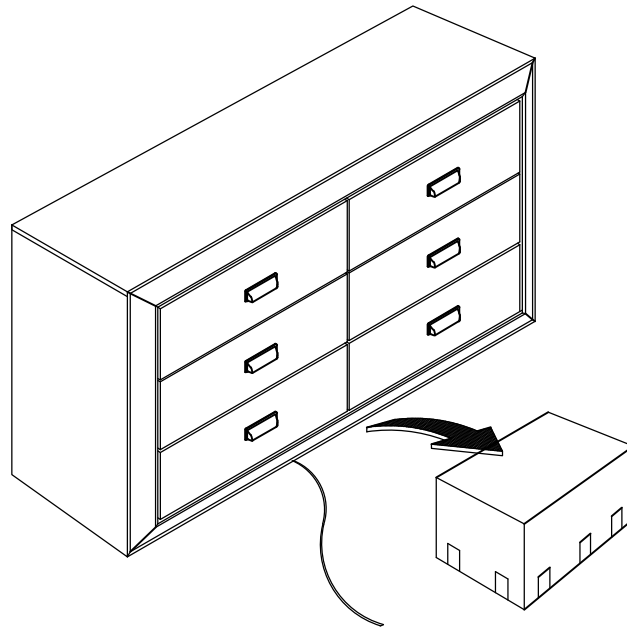
**2**

Align and tighten Front Right Feet (FR) (B), Front Left Feet (FL) (C), Rear Right Feet (BR) (D) and Rear Left Feet (BL) (E) to unit according to the position left and right. Follow the label correctly using JCBC Bolt (G), Spring Washer (H) and Flat Washer (I) and fully tighten with Allen Key (J). Align and tighten Support Leg (F) to bottom panel of Dresser (A) by turning Support Leg (F) clockwise until tight.

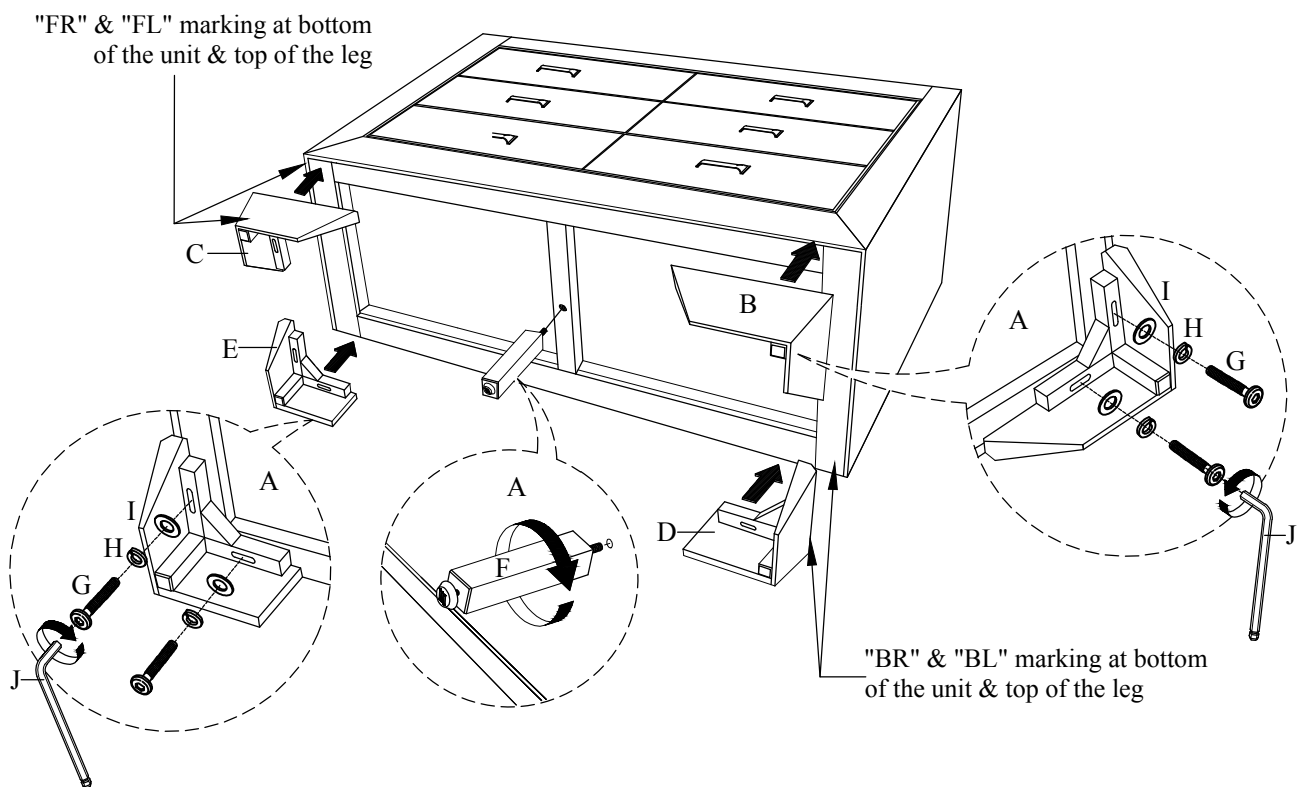

3

Attach Anti-Tipping Kit (K) to wall. Attach bracket (vertically) to wall using the long screw provided. Attach bracket (vertically) to wall with short screw. Place bracket as close to center of furniture back as possible in relation to wall stud and the desired position in the room. Move furniture to its final position. Thread the strap through bracket and pull it tight.

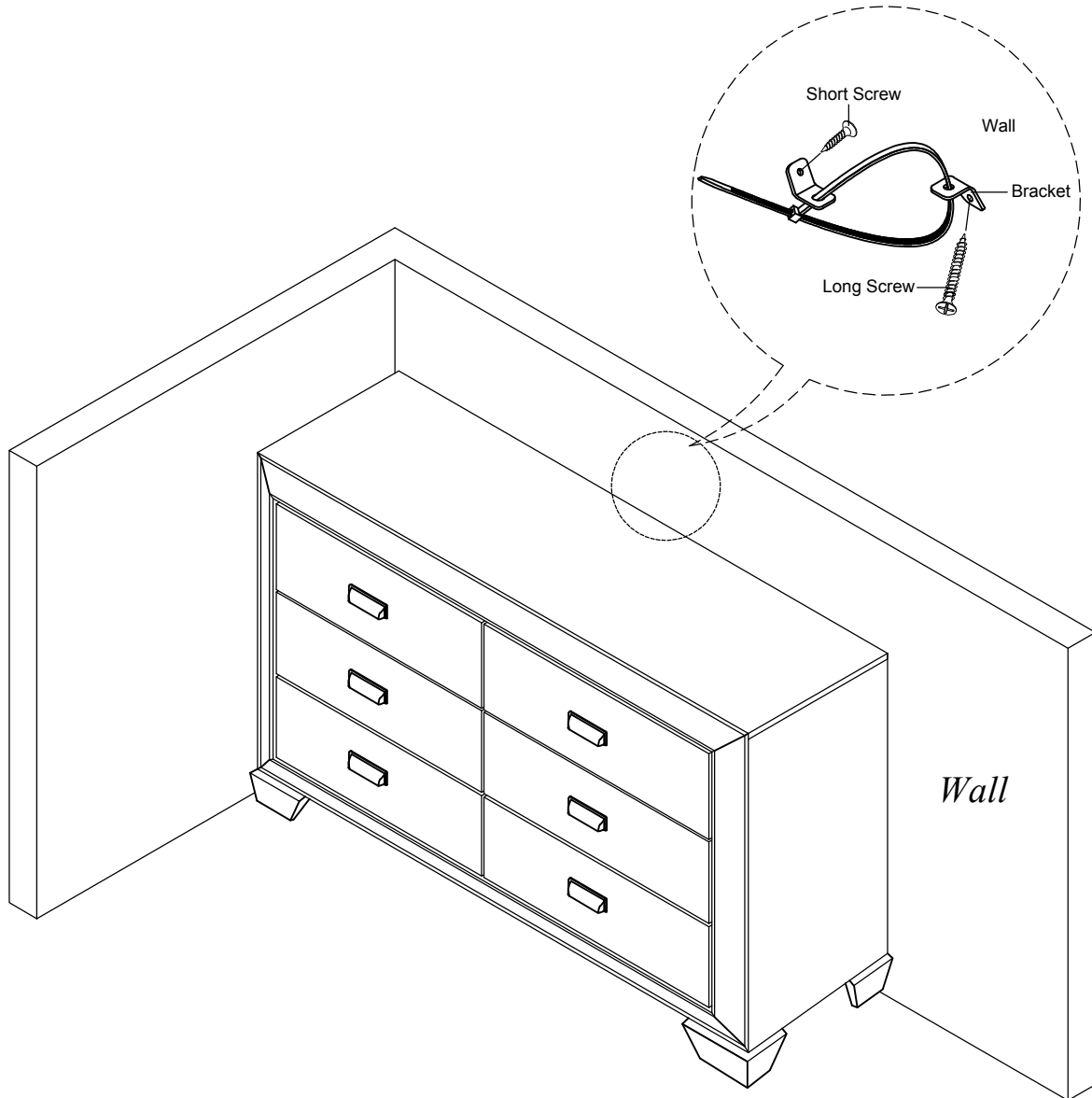
**CLEANING & CARE**

Treat surface with care. Surface is resistant to scratches but is not scratch resistant. Clean surfaces with a dry or damp soft cloth. Do not use abrasive cleaners. Hardware may loosen over time. Periodically check that all connections are tight.