



Text 1-812-652-2525
(US and Canada only, carrier fees may apply)



Visit www.maxicosi.com



Call 1-800-544-1108



Email support@djgusa.com



Learn More

©2024 Dorel Juvenile Group, Inc. (800) 951-4113 www.maxicosi.com. Styles, colors, and labeling may vary. Made in China. Distributed by Dorel Juvenile Group, Inc., 2525 State St., Columbus, IN 47201-7494. Dorel Juvenile Canada, 2233 Argenta Road, Suite 110, Mississauga, ON L5N 2X7. Representante exclusivo en Chile: DOREL JUVENILE CHILE S.A. Av. del Parque 4161, oficina 602 A, Huechuraba, Santiago, Chile - Fono: 56 2 24971500 - www.infanti.cl - www.dorel.cl. Importado y distribuido en Perú por: COMEXA COMERCIALIZADORA EXTRANJERA S.A. SUCURSAL DEL PERÚ - Los Libertadores 455, San Isidro, Lima 27, Lima, Perú RUC 20431062870 - Fono: 4413029 - www.infanti.com.pe. En Centro América, Caribe y Ecuador por: Best Brands Group S.A. - Av. Balboa, Bay Mall Plaza, Planta Baja, local 9, Panamá. - Fono: (507) 300 2884. En Colombia por: Baby Universe S.A.S. - Vía 40 No. 77-29, Barranquilla, Colombia - Fono: (575) 353 1110 Importador: DJGM, S.A. DE C.V. Gabriel Mancera No. 1041 Col. Del Valle, Benito Juárez C.P. 03100 México, Ciudad de México R.F.C. DJG140305GN9 Tel. (55) 67199202 03/24 4358-8508

DOREL



MAXI-COSI[®]
KINDRED COLLECTION

Kiskadee
360° Rotating
High Chair

HC280
Keep these instructions for future reference.



A close-up photograph of a wooden chair leg, likely made of oak, showing a small, rectangular metal plaque with the 'MAXI-COSI' logo embossed on it. The wood grain is clearly visible, and the lighting is warm and soft.

Introducing the Maxi-Cosi Kindred Collection

Our Maxi-Cosi Kindred Collection is inspired by the ancestry, connection, and inseparable bonds of Family. When you choose to invite us into your home, you allow us to become a part of your life.

These pieces are more than furniture or baby products—they're carriers and keepers of cherished memories and family ties. Their exceptional quality and craftsmanship mean that the memories they'll make are countless. Each Maxi-Cosi Kindred Collection piece is thoughtfully created, reflects a timeless design, features special metals and EcoCare premium, recycled fabric made from plastic bottles, and is meant to be loved and shared.

The Maxi-Cosi Kindred Collection
Lineage in design.

Table of Contents

MODES OF USE	5
WARNINGS	7
ASSEMBLY	11
Parts	12
Legs	14
Footrest	16
Seat	17
Trays	17
USE	19
Tray	20
Restraint	20
Recline	22
Seat Rotation	22
Booster Seat	23
CARE AND MAINTENANCE	26
Replaceable Parts	27
Warranty Information	27

See back cover for contact information and support.

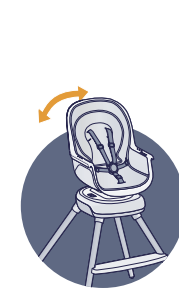

High Chair with Infant Recline

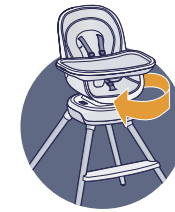

Upright with Tray
(seat can rotate 360°)

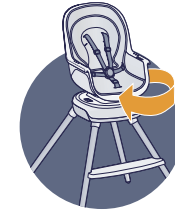

Upright without Tray
(seat can rotate 360°)



Toddler Booster Seat
(no tray)



Infant Booster Seat



2 Kids at Once

Modes of Use

Easily transition through the modes as your little one grows and develops.

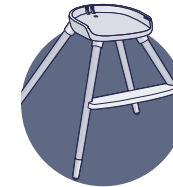

Child Stool

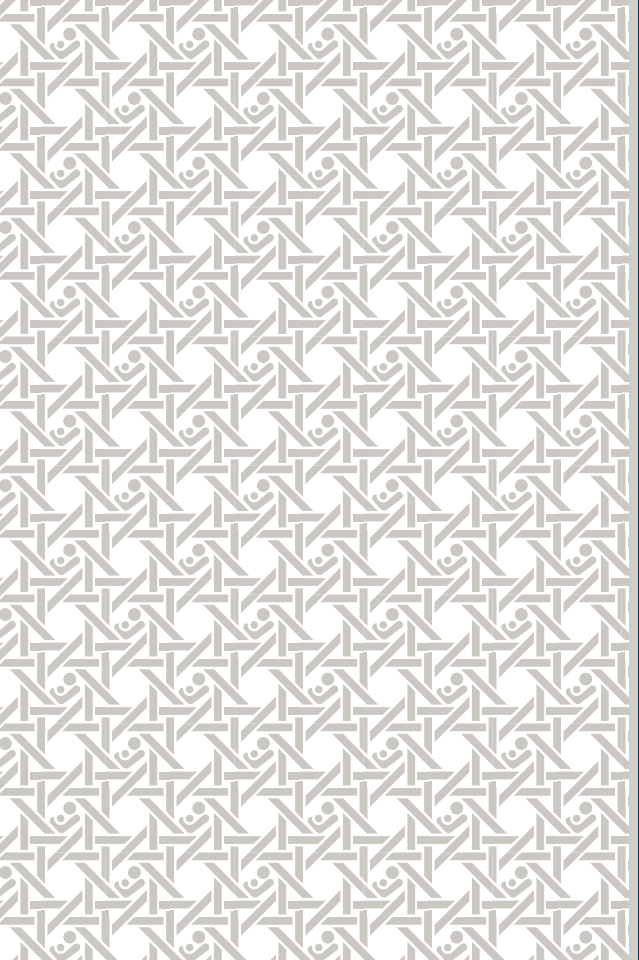

Warnings

Read all instructions before assembly and use of product. Keep instructions for future reference.

Note: Actual fit may vary. Not all children will comfortably fit in the seat for the full weight and height ranges listed.

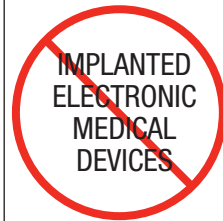

Do not use the magnetic chest clip with children who have an implanted electronic medical device. A magnet is used to help secure the chest clip locking mechanism together which may interfere with proper function of an implanted electronic medical device. Parents or caregivers who have an implanted electronic device should keep their device away from the chest clip and consult their doctor and medical device manufacturer for specific information before using the chest clip. If a parent/caregiver or child has an implanted electronic medical device, please contact Dorel Juvenile (see back cover) for a replacement (non-magnetic) chest clip free of charge.

High Chair Mode

Suitable for children up to 3 years old. Maximum weight 40 lb (18.1 kg).

⚠ WARNING

FALL HAZARD: Children have suffered **severe** head injuries including skull fractures when falling from high chairs. Falls can happen suddenly if child is not restrained properly.

- **ALWAYS** use restraints, and adjust to fit snugly.
- Tray is not designed to hold the child in the chair.
- Stay near and watch child during use.
- Stay near and watch baby during use. This product is not safe for sleep or unsupervised use. If baby falls asleep, remove baby as soon as possible and place baby on a firm, flat sleep surface such as a crib or bassinet.

- **NEVER** use high chair in reclined positions when child is able to sit upright unassisted or weighs more than 20 lb (9.1 kg).
- **DO NOT** lift or move high chair with child in it.
- The child should be secured in the high chair at all times by the restraint system, both in the reclined and upright positions.
- It is recommended that the high chair be used in the upright position only by children capable of sitting upright unassisted.
- **DO NOT** recline seat with child in it.
- Keep small parts away from children when assembling.

Booster Seat Mode

Suitable for children who can sit up unassisted (approximately 6 months) up to 5 years old. Maximum weight 50 lb (22.7 kg). Booster seat fits most kitchen and dining room chairs with a minimum measurement of 12" W x 14.5" D and backrest height of 12.5" H.

⚠ WARNING

Children have suffered **head injuries** including skull fractures, after falling with or from booster seats.

- Check that booster seat is **securely attached** to adult chair before each use.
- **Always use restraints** until child is able to get in and out of booster seat without help. Adjust to **fit snugly**.
- **Never** allow child to **push away from table**.
- **Never lift** and **carry** child in booster seat.
- **Stay near** and **watch** your child during use.
- **ALWAYS** fasten seat and back straps securely to adult chair.
- **ALWAYS** ensure that all chair protector pads are located completely on the adult chair surface.

- This booster seat is only to be used with standard kitchen or dining room chairs. **NEVER** use this product as a bath seat, on a tabletop, stool, swivel chair, or any other seating surface where the straps cannot secure it properly.
- **ALWAYS** remove child before adjusting booster seat.
- Until child is able to get in and out of the booster seat without help (about 2 1/2 years old), the child should be secured in the booster seat at all times by the restraining system. The tray is not designed to hold the child in the chair.
- Use this product only for children capable of sitting upright unassisted.
- **ALWAYS** use booster seat mode in the upright position.
- Prevent death or serious injury. **DO NOT** use in motor vehicle.

Child Stool Mode

Suitable for children 3 years and older, up to 50 lb (22.7 kg).

⚠ WARNING

FALL HAZARDS: Children have suffered severe head injuries including skull fractures when falling.

- Stay near and watch child during use.
- **Never lift** or **move** stool with child on it.

- **NEVER** allow child to stand on stool.
- Only use for a child that is able to get in and out of stool unassisted.
- Recommend for indoor use only.



Assembly

Parts

- A Seat assembly
 - A1 Seat pad
 - A2 Infant insert
 - A3 Restraint belt
 - A4 Chair strap compartment
 - A5 Rotate seat button
 - A6 Recline button
- B Stool seat
 - B1 Remove seat button
- C Tray insert
- D Main tray

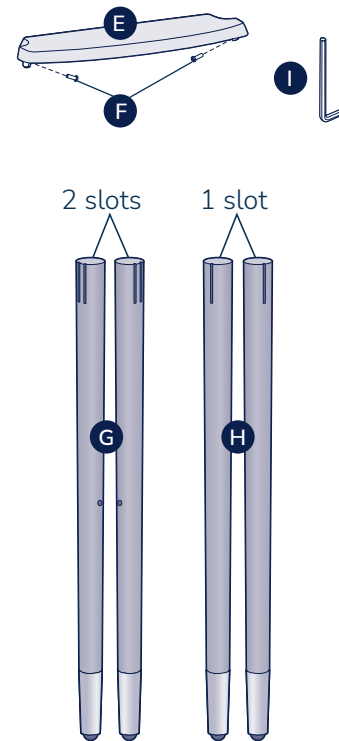
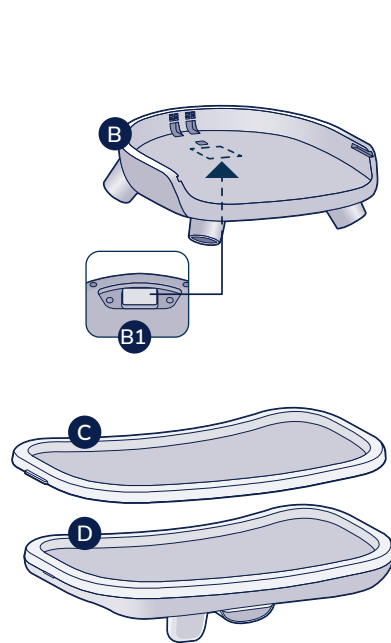
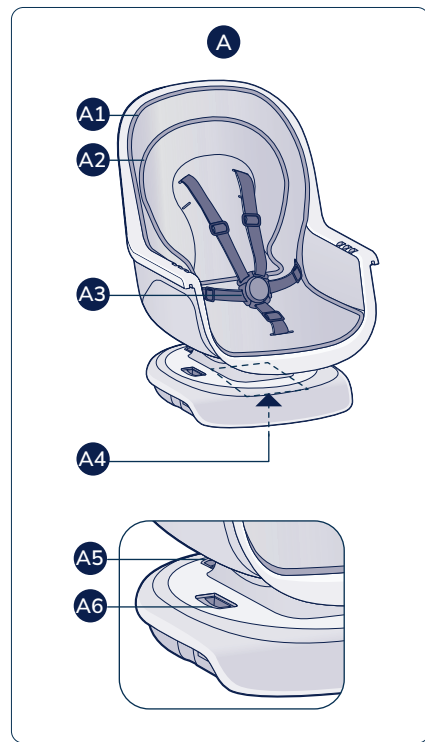

Do Not Use This Way:



SEAT WITHOUT LEGS

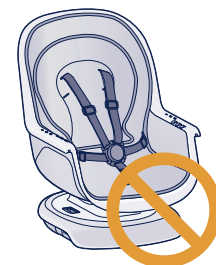

BOOSTER SEAT ON FLOOR

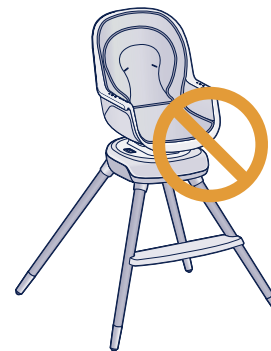

WITHOUT THE RESTRAINT SYSTEM

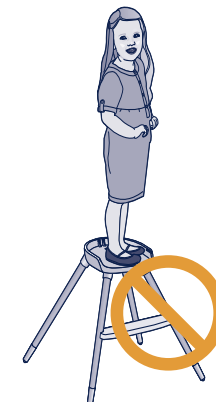

STANDING ON THE STOOL

Parts

- E Footrest with brackets
- F Hex head screws (2)
- G Front legs (2)
- H Rear legs (2)

Tool required

- I Allen wrench (included)

Adult assembly required.

Assembly

Front Legs (right and left)

Turn the seat over (Figure 1a).

Locate the front legs with 2 slots on the top (Figure 1b). Orient the legs so the footrest holes face one another (Figure 1c). Align the slots and tabs (Figure 1c).

Insert the legs into the seat until each pin “clicks” and the pins protrude through the holes.

Tip: Squeeze the buttons while sliding the legs in.

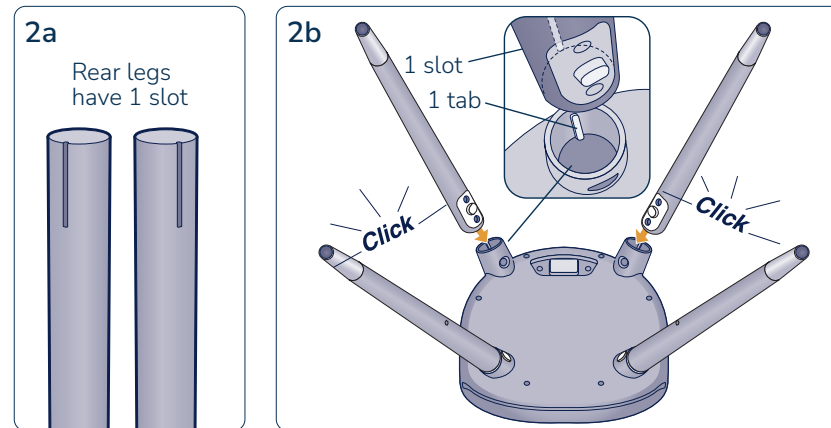
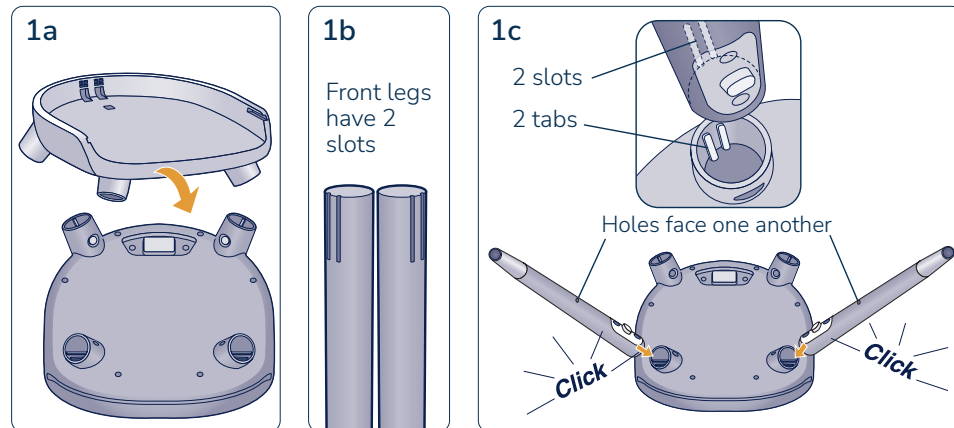

Assembly

Rear Legs (interchangeable)

Arrange the 2 rear legs with the slot aligned with the tab (Figure 2b).

Insert the legs until each button “clicks” and the buttons protrude through the holes (Figure 2b).

Pull on all four legs to ensure that are securely in place.

Assembly

Footrest

Note: Brackets are pre-installed on the footrest.

Align the footrest brackets to the holes on the front legs (Figure 3a).

Use the included Allen wrench to attach the brackets on the footrest to the legs with the 2 provided screws (Figure 3b).

Turn the stool right side up (Figure 3c).

Note: Don't use power tools to install the screws.

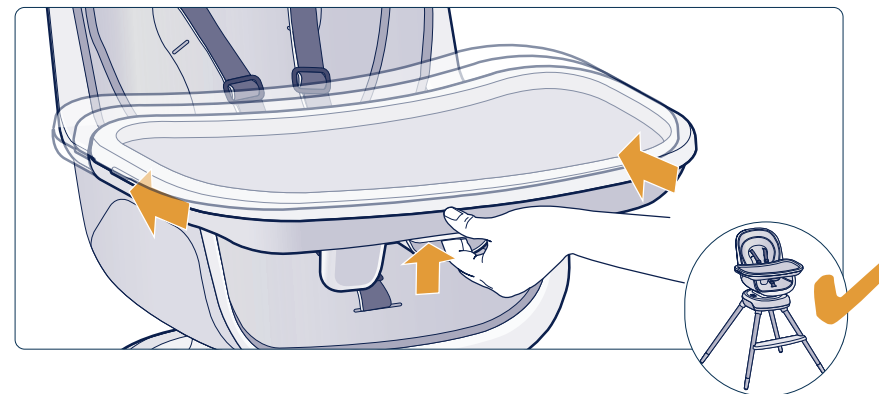
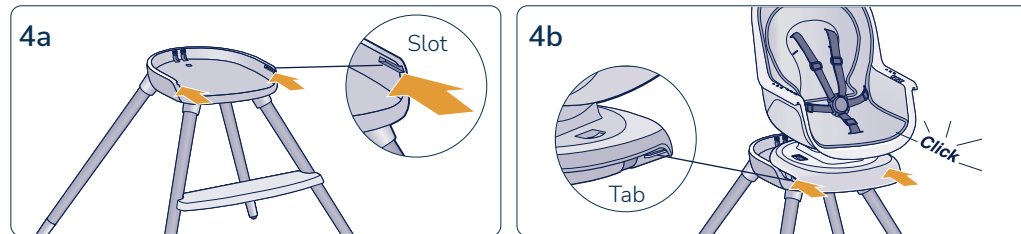
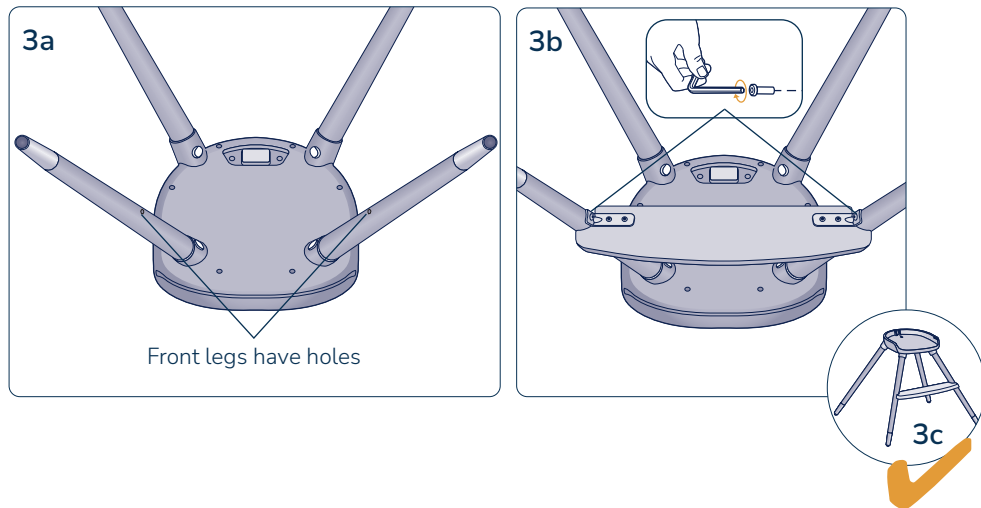

Assembly

Seat

Locate the slots on the front of the stool seat (Figure 4a).

Slide the seat tabs into the slots (Figure 4b) and push the seat back until it clicks into place.

Pull the seat forward to ensure it is securely in place.

Trays

Note: The trays are made without BPA.

Squeeze the button under the front of the tray and slide the tray onto the high chair.

Place the insert tray on top of the main tray and push down to secure.



Use

Use

To adjust the tray:

There are three tray positions. Squeeze the button under the front of the tray and slide the tray forward and backward.

To remove the tray:

Squeeze the button on the front of the tray and pull toward you.

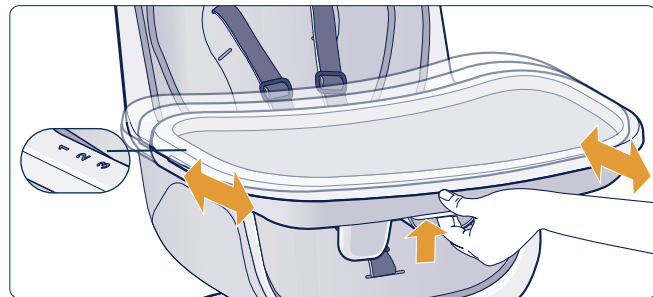

Restraint

Place your child in the seat with the crotch strap between the child's legs. Place shoulder restraints over the child's shoulders and fasten both buckles.

Never use high chair or booster without restraints.

To unbuckle the restraint, press the side buttons.

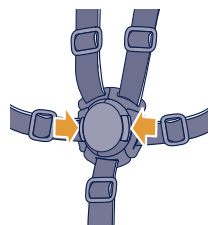

The center cover is removed.

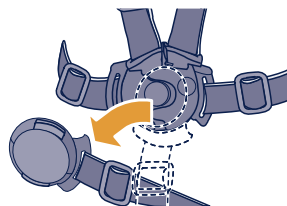

Pull the sides apart.

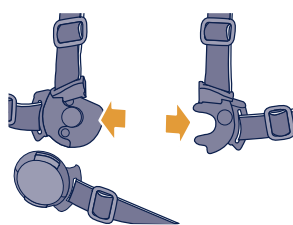

To buckle the restraint: If the shoulder straps detach, slide each buckle tongue onto the tab on top of the buckle.

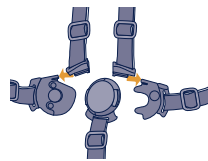

Fit each side together.

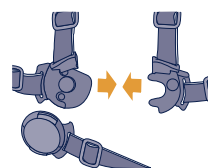

Press the center cover onto the restraint.

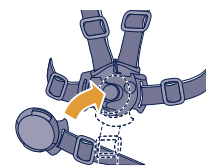

Buckled.

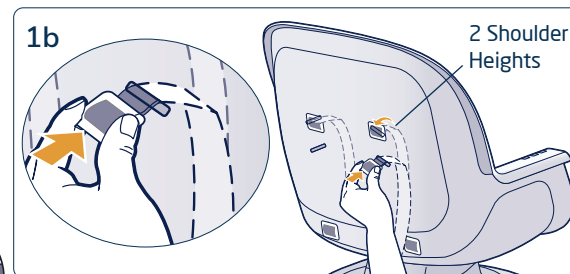
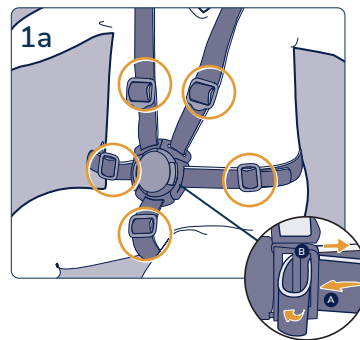
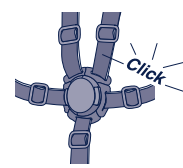

Use

Adjust the Restraint

Adjust straps (at the five buckles) to tighten snugly so that you can comfortably slide your finger between the strap and your child (Figure 1a). To adjust shoulder straps, slide the buckle up to tighten and down to loosen.

To adjust waist straps, loosen the strap at the buckle (see inset). Feed the strap end (A) through the buckle (B) and waist clip towards the back of the chair to tighten (strap end will get longer) or away from the back of the chair to loosen (strap end will get shorter).

As your child grows, you may need to adjust the shoulder strap height. Push the strap anchors through the seat back and seat pad (Figure 1b). Push the strap anchor back through into the upper slot.

Use

Adjust the Recline

Remove the tray. Place one hand on the seatback. With your other hand, press the recline button on the side of the seat base, while pushing the seatback down to recline. There are three positions.

Note: Do not recline the seat with a child in it.

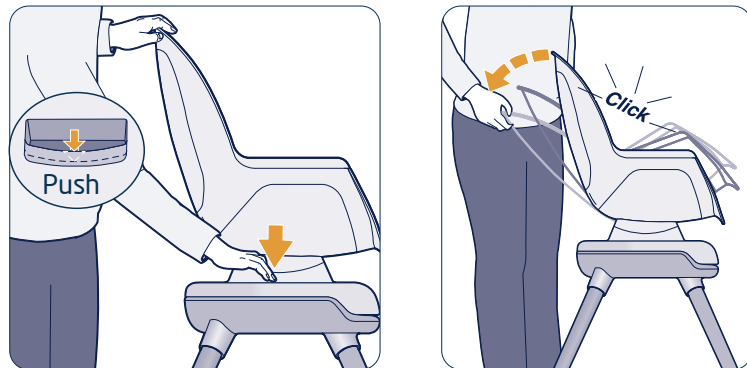

Rotate the Seat

Press the rotate button on the back of the seat base and turn the seat.

The seat will stop rotating every 90° and click into place.

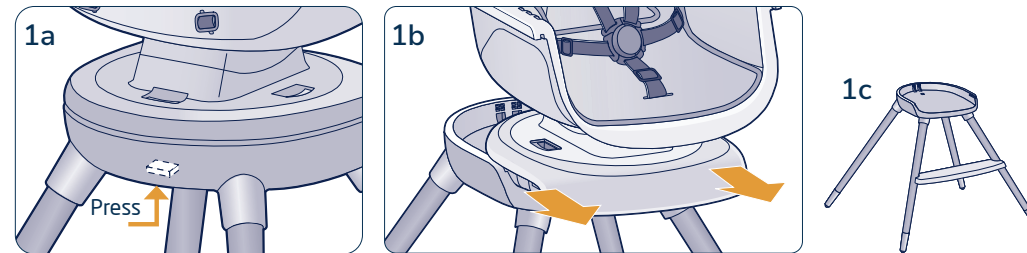
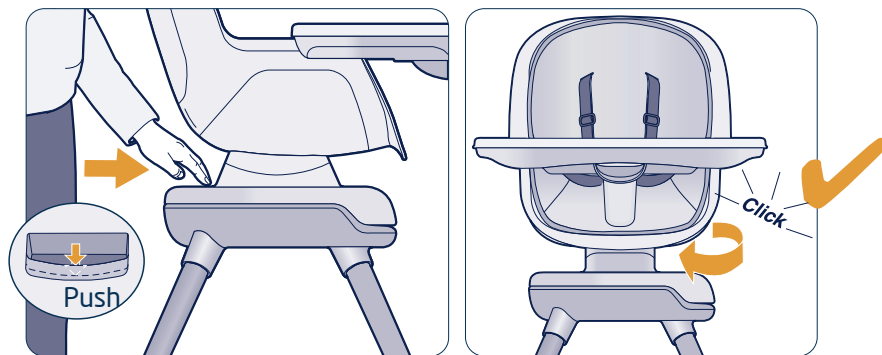

Use

Booster Seat

Remove the Seat:

The release seat button is under the stool, between the rear legs. Press the seat release button (Figure 1a) and slide the seat off (Figure 1b).

Set the stool aside.

Note: This is how you convert from high chair mode to child stool mode.

Chair Straps (2 sets):

Turn the seat upside down to locate the compartment underneath (Figure 2a).

Open the compartment and locate the chair straps (Figure 2b).

Remove the straps and close the compartment (Figure 2c).

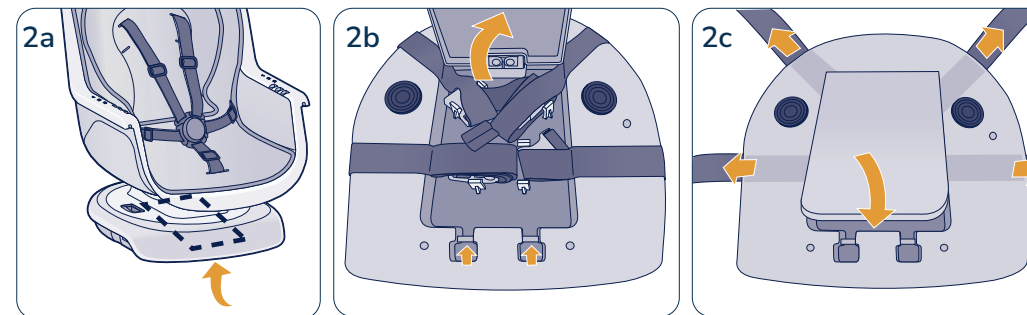

Use

Booster Seat

Orient the chair straps with the loop facing outwards threaded through the buckle (Figure 3a).

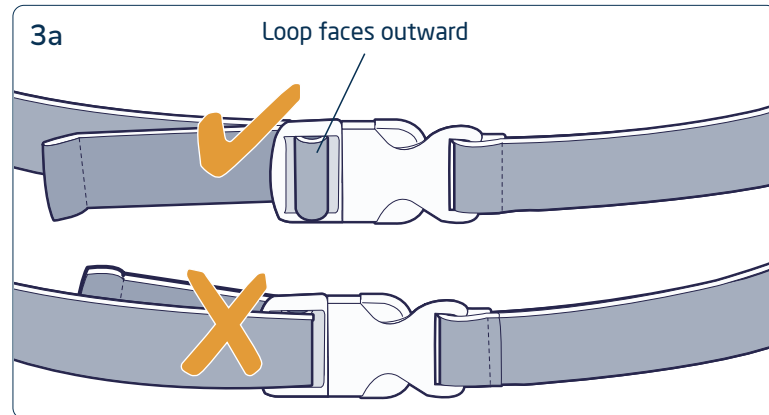

3b

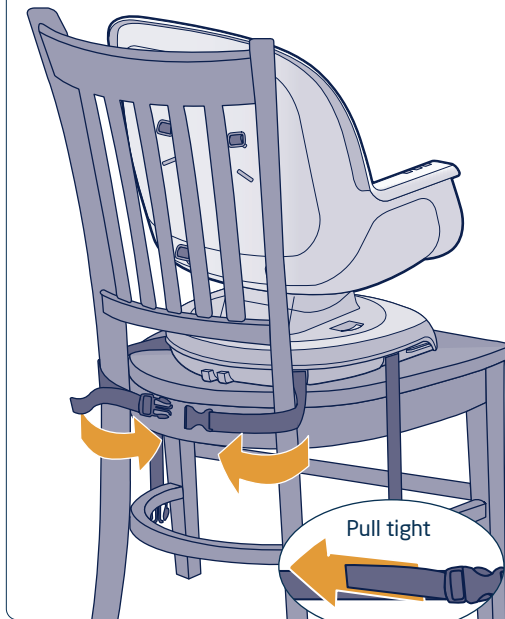

3c

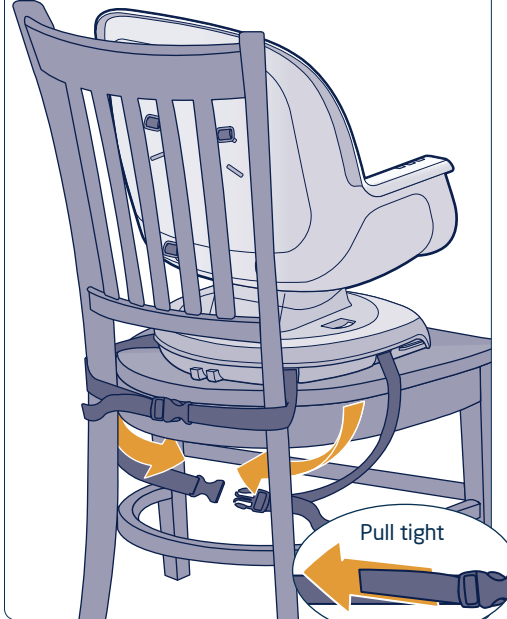

NOTE: Seat must be in upright position for booster seat mode.

Booster seat fits most kitchen and dining room chairs with a minimum measurement of 12" W x 14.5" D and backrest height of 12.5" H.

Use

Booster Seat

Pass the rear strap around the back of the chair and secure the buckle (Figure 3b).

Pass the bottom chair strap under the base of the chair and secure the buckle (Figure 3c).

Pull both strap ends to tighten the chair straps.

Care and Maintenance

Care and Maintenance

High chair and trays:

Wipe with a soft, damp cloth and warm, soapy water and allow to drip-dry. Tray insert is dishwasher-safe.

Restraint system:

Restraint and crotch straps should be surface washed and drip-dried only. Do not place in washing machine or dryer.

Seat pad:

Unbuckle the restraints (Figure 1a). Push all five straps through the slots and uninstall the strap anchors from the seat. Machine wash the seat pad in cold water on gentle cycle. Do not bleach. Drip-dry. Do not iron.

To reassemble the seat pad:

Reinstall all five strap anchors to the seat, choosing the shoulder slots that best fit your child's size. Then thread straps through the seat pads (Figure 1b).

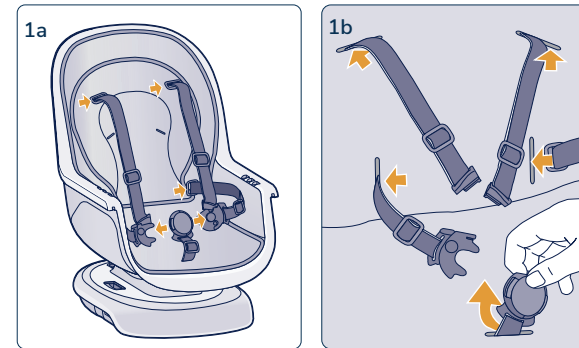

Replaceable Parts

- Tray insert
- Restraint belt
- Seat pad
- Front and rear legs (4)
- To order parts call 1-800-544-1108 or text 1-812-652-2525. Include the model number (HC280), manufacture date (found under the seat), and a brief description of the part.
- Main tray
- Footrest
- Infant insert
- Screws (2)

Two-Year Limited Warranty

Dorel Juvenile Group, Inc. warrants to the original purchaser that this product (Kiskadee) is free from material and workmanship defects when used under normal conditions for a period of two (2) years from the date of purchase. Should the product contain defects in material or workmanship Dorel Juvenile Group, Inc., will repair or replace the product, at our option, free of charge. Purchaser will be responsible for all costs associated with packaging and shipping the product to Dorel Juvenile Group Consumer Care Department at the address noted on the back cover and all other freight or insurance costs associated with the return. Dorel Juvenile Group will bear the cost of shipping the repaired or replaced product to the purchaser. Product should be returned in its original package accompanied by a proof of purchase, either a sales receipt or other proof that the product is within the warranty period. This warranty is void if the owner repairs or modifies the product or the product has been damaged as a result of misuse. This warranty excludes any liability other than that expressly stated previously, including but not limited to, any incidental or consequential damages.

SOME STATES DO NOT ALLOW THE EXCLUSION OR LIMITATION OF INCIDENTAL OR CONSEQUENTIAL DAMAGES, SO THE ABOVE LIMITATION OR EXCLUSION MAY NOT APPLY TO YOU. THIS WARRANTY GIVES YOU SPECIFIC LEGAL RIGHTS, AND YOU MAY ALSO HAVE OTHER RIGHTS THAT MAY VARY FROM STATE TO STATE.