

Installation Instructions

Propane (LP) Gas Conversion Kit WE49X32950

GTD40GBMRWS, GTD45GBMRWS, GTD33GASKWW, GTD42GASJWW, GTD45GASJWS, GTX22GASKWW, GTX33GASKWW, GTX42GASJWW, HTX21GASKWW, HTX24GASKWS, NTX62G8STWW, XTD72G8STWS, PTD60GBSRWS, PTD60GBPRDG, PTD70GBPTDG, PTD70GBSTWS, PTD80GBPTRS, PTD90GBPTRS, GTD58GBSVWS, GTD58GBPVDG, PTD70GBPTRS, PTD90GBPTDG

⚠ WARNING This conversion kit shall be installed by a qualified service agency in accordance with the manufacturer's instructions and all applicable codes and requirements of the authority having jurisdiction. The information in these instructions must be followed to minimize the risk of fire or explosion or to prevent property damage, personal injury or death. The qualified service agency is responsible for the proper installation of this kit. The installation is not proper and complete until the operation of the converted appliance is checked as specified in the manufacturer's instructions supplied with the kit. CANADA: THE CONVERSION SHALL BE CARRIED OUT IN ACCORDANCE WITH THE REQUIREMENTS OF THE PROVINCIAL AUTHORITIES HAVING JURISDICTION AND IN ACCORDANCE WITH THE REQUIREMENTS OF THE CSA B149.1 INSTALLATION CODE.



⚠ WARNING

- Turn the dryer's gas shut-off valve in the supply line to the OFF position.
- Disconnect dryer from electrical supply.
- Wear gloves and arm guards.
- Failure to do so may result in explosion, fire, electrical shock or lacerations.





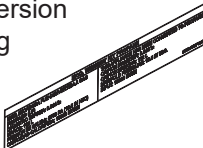

This kit (**located in the dryer's backslash**) is to be used with gas dryers listed above as well as dryers for which **WE49X32950** appears on the rating plate.

This kit was designed to be used with propane (LP) gas equipped with a **nozzle** that provides line pressure between a minimum of 8" (1993 Pa) water column and maximum of 11" (2740 Pa) water column at the connection to the dryer.

CONTENTS



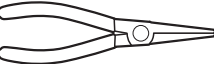

- Orifice (Stamped 132L) 
- Conversion Record Label 
- Responsibility Label 
- Conversion Rating Plate 

TOOLS YOU WILL NEED

- Gloves and arm guards 
- Safety glasses 
- Soap solution for leak detection 
- Phillips screwdriver 
- Flat-blade screwdriver 
- Needle nose pliers 
- 3/8" open end wrench 

TOOLS AND MATERIALS YOU MAY NEED

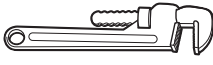
NOTE: Needed only if the dryer has not yet been connected to gas supply - See the **Installation Instructions** shipped with the dryer.

- 10" (25.40 cm) Adjustable wrenches (2) 
- Flexible gas line connector 
- 8" (20.32 cm) Pipe wrench 
- Gas pipe adapters (2), elbow and pipe plug 
- Pipe compound or PTFE tape 



31-3000407 Rev 1

Installation Instructions

1. Remove the two hex head screws from the top rear corners of the control panel.

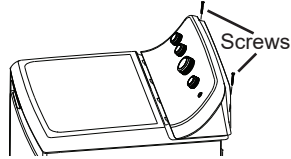

2. Grasp the control panel sides, push it back, and roll it up and off. Carefully lay it on its face on the top cover.

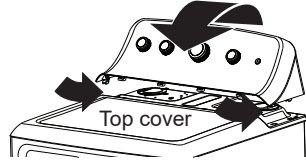

3. Remove the five screws from the control panel back cover. The conversion kit is now accessible.

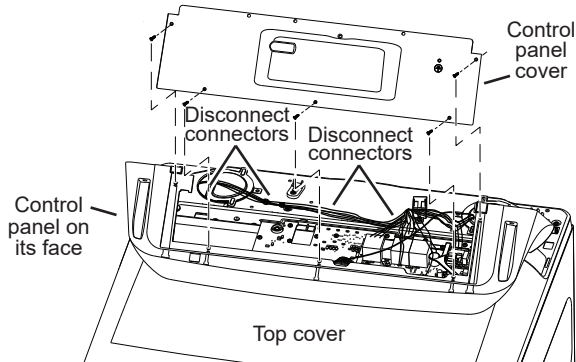

Disconnect the connectors from the control board and set the control panel aside.

4. Remove the screws/rear cover plates from the top cover.

Remove the ground wire screw from the back right corner opening.

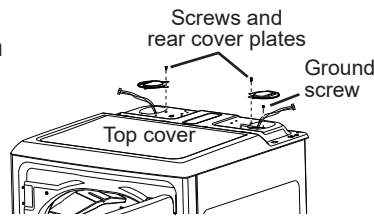

5. Remove the two phillips head screws from the back corners of the top cover.

Open the dryer door and remove the two screws from the front underside of the top cover.

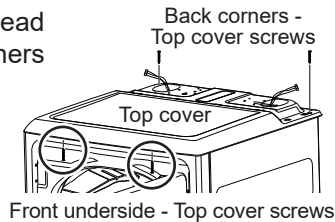

6. Grasp the front corners of the top cover, lift up, slide back and lift up. Hold the top cover with one hand, push the wiring harnesses through the openings and then set the top cover aside.

Remove the front panel by removing the two screws from the top front panel corners, and disconnect all of the connectors and the water line. Set the front panel aside.

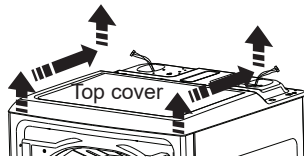

7. Determine which gas valve style is on the dryer - Either **Style A** or **Style B** - and follow its directions:

Style A

If you have **Style A**, order Kit **WE25X217** and follow its instructions. Order on-line at GEApplianceparts.com today, 24 hours a day, or by phone at 877.959.8688 during normal business hours.

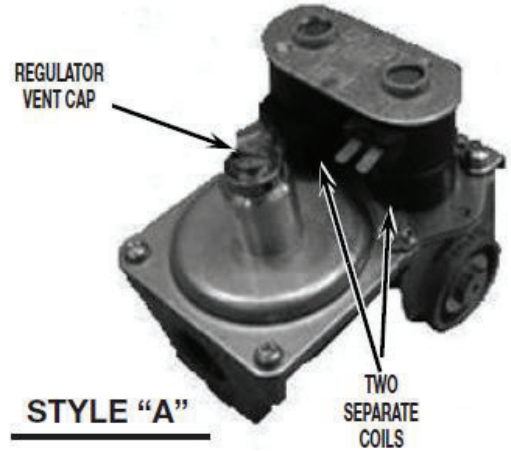

Style B

Observe the cover dial settings indicated as NG (Natural Gas) and LPG (Liquefied Propane gas) along with the gas type setting indicator.

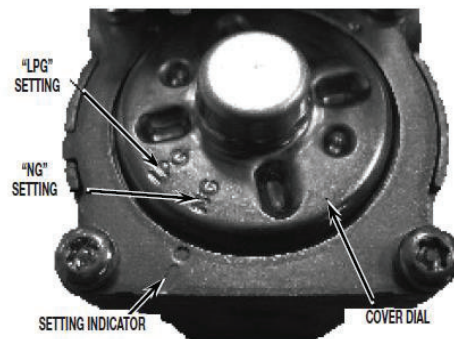
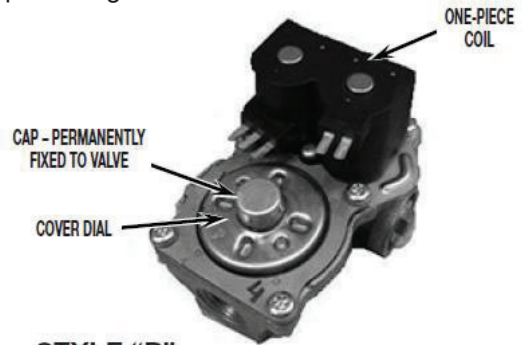

Installation Instructions

Style B (Continued)

Position a pair of needle nose pliers into the slots of the cover dial. **NOTE:** A flat-blade screwdriver may be used if needle nose pliers are not available.

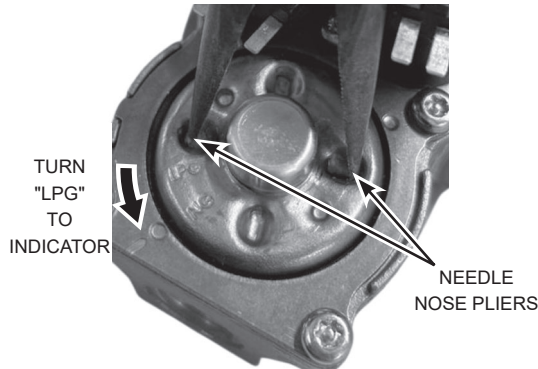

Rotate the dial counterclockwise, lining up "LPG" marking with the indicator on the gas valve.

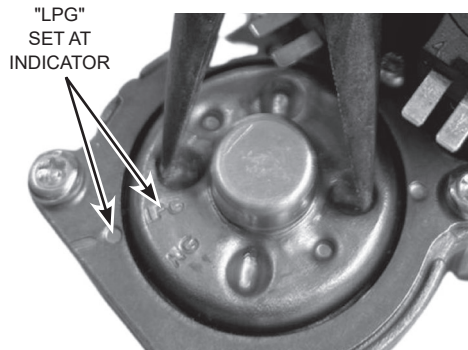

8. Using a 3/8" wrench, remove the NG burner orifice from the gas valve assembly turning it counterclockwise. Install the LP orifice from this kit.

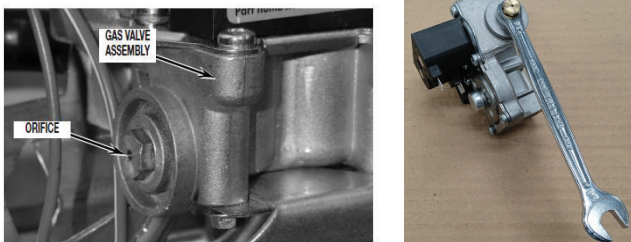

NOTE: Save the original orifice in case it is required to convert the dryer back to natural gas at a later date.

9. Place the Conversion Record Label on the side of the gas valve.



10. Connect the gas inlet pipe to the main gas supply.
11. Before assembling the remainder of the components, open the gas supply valve and check all connections for leaks with a soapy solution or equivalent. The leak test solution must not contain ammonia which could cause damage to the brass fittings. If leaks are found, close the valve, retighten the joint, and repeat the leak test.
12. Reassemble the dryer by following steps 1 through 6 in reverse.
13. Complete responsibility label and affix to outer surface of rear panel near gas inlet pipe.
14. Reconnect electrical power supply.
15. To make sure the dryer is working properly:
 - A. Turn dryer on.
 - B. Run on high heat for 5 minutes to purge gas pipe.
 - C. Verify that the igniter ignites the flame properly.
16. Open the dryer door and apply the conversion rating plate as near as possible to the original rating plate.

NOTES:

- Manifold pressure of converted dryer is 10.5" water column (2613 Pa).
- Required input rating of converted dryer is 19,000 BTU/HR.
- Clothes dryer input ratings are based on sea level operation and need not be changed for operation up to 2000 ft elevation. For operation at elevations above 2000 ft., input ratings should be reduced at the rate of 4 percent for each 1000 ft. above sea level.
- Gas inlet pressure should be measured and adjusted in accordance with regulations and best practices.
- Burner is designed to produce quality flame with correct manifold pressure and orifice. No additional adjustments are necessary.

Installation checklist:

- Orifice (stamped - 132L)
- Conversion Record Label
- Responsibility Label
- Conversion Rating Plate

