



The installation must only be performed by a licensed electrician.

To prevent death, injury or damage to property, this product must be installed in accordance to National Electrical Code (NFPA70) in the US or Canadian Electrical Code (CSA 22.1) in Canada.

Disconnect power before installing the product or servicing it.

Wait until fixture has cooled down before installing or servicing the fixture.

MIN. 90°C SUPPLY CONDUCTORS

What's In The Box

One (1) TPC Select Edgelit LED Troffer

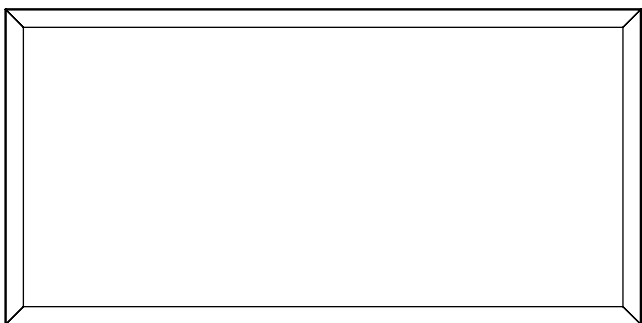

Tools Needed

This Edgelit LED Troffer requires very few tools for installation. A drill or a screwdriver and a pair of wirecutters. Sheet metal screws can be used to attach the fixture to the T-grid or framing.

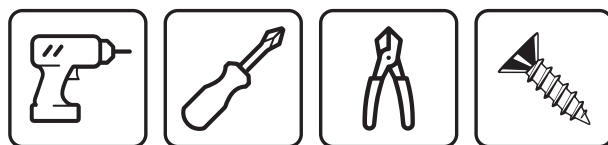

- 1** Carefully unpack the fixture from its packaging. Inspect product for defects due to shipping.

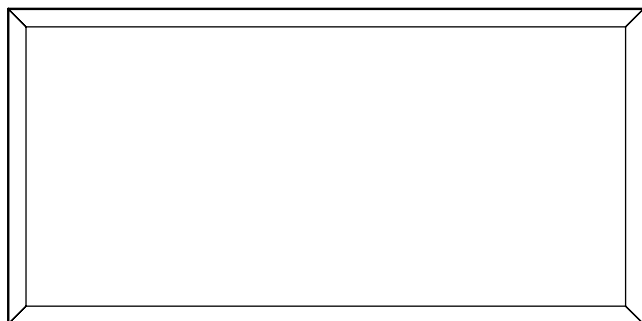

- 2** Locate desired positioning for fixture in ceiling grid. Remove ceiling tiles if necessary.

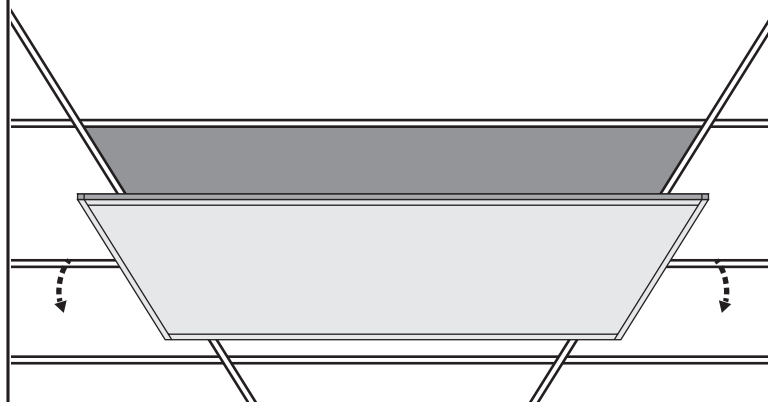

- 3** Turn off power to appropriate circuit at the breaker panel.

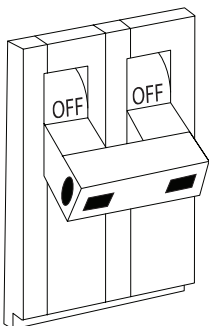

- 4** Bend grid mounting tabs.

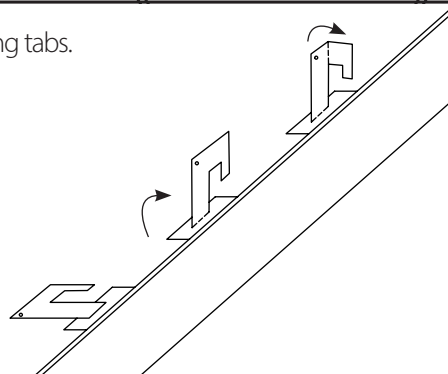

- 4 Place fixture into the T-grid ceiling panel. Secure to structure and/or grid per state and local codes.

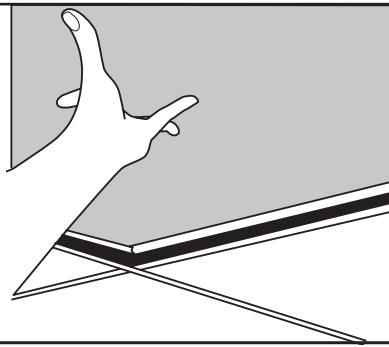

- 5 Remove access plate from junction-box (do not discard) by removing screws.

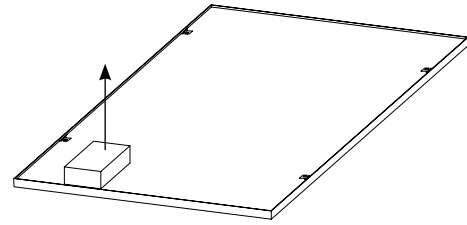

- 6 Connect wiring as shown.

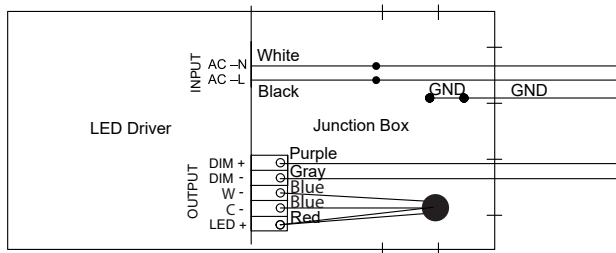

- 7 Reattach cover of junction box and secure with screw. To adjust CCT or Lumen output, set the switch positions on the side of the driver to the desired settings.

Note:

- 1) Power selection switch is a three-position switch that will adjust light output: low/medium/high.
- 2) CCT selection switch is a three-position switch that will adjust Color Temperature between 3500K, 4000K, or 5000K.

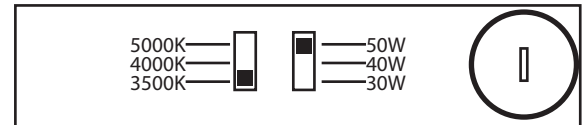

- 8 Turn power on and verify that the panel is lit.

LED EXPRESS LIMITED WARRANTY

Subject to the exclusions below, each NICOR LED product, including the LED electronics and components of a property installed NICOR LED product, will be free from defect in materials and workmanship for a period of five (5) years from the original date of purchase. The product shall be considered defective only if 10% or more of the product's LED components fail. NICOR LED product warranty covers the following performance criteria: LED Light Output will be maintained above 70% of initial output; LED color temperature will not shift more than 200K in CCT; LED driver will operate within NICOR specifications; and the fixture finish, excluding natural aluminum or brass products, will not exhibit cracking, peeling, excessive fading, or corrosion during the warranty period. Exceptions apply as defined in NICOR's product specification sheets, which are incorporated by reference herein.

This limited warranty is provided to you, the purchaser of the product identified on Seller's invoice, as your exclusive remedy and applies only to NICOR products that have been purchased from an authorized NICOR Distributor; the product was new and in an unopened NICOR package at the time of installation; and the NICOR product was installed by a licensed electrician or under the supervision of a licensed electrician and used by consumers in the United States or Canada when accompanied with this warranty. This warranty extends only to the first consumer purchaser and is not transferable. A consumer wishing to invoke the terms of this limited warranty must first obtain a RGA number within 30 days of discovery of the defect, and return the product to NICOR for inspection. Once verified to be covered by this limited warranty, NICOR will, at its sole discretion, repair, replace, or refund the purchase price of any product that does not conform to this limited warranty. If NICOR, at its sole discretion, determines that the product should be repaired or replaced, this warranty is limited to the reasonable, customary, and necessary costs and expenses associated with the repair/replacement. This warranty requires that all repair/replacement estimates and costs, including but not limited to equipment rental (if any), and any other cost or expense to be incurred in the repair/replacement of the product, be approved in advance and in writing by NICOR.

FAILURE TO OBTAIN NICOR'S ADVANCE WRITTEN APPROVAL OF ALL REPAIR/REPLACEMENT COSTS AND EXPENSES IN WRITING SHALL VOID THIS LIMITED WARRANTY.

THIS LIMITED WARRANTY DOES NOT COVER THE FOLLOWING:

- Defects or damages resulting from improper installation, operation, storage, misuse or abuse, accident, or neglect;
- Defects or damages resulting from improper service, testing, adjustment, installation, maintenance, alteration, connection to out-of-specification electrical service, corrosive or damp environments, or connection to incompatible equipment or devices (e.g., connecting non-dimmable lighting products to dimmers);
- Damage which occurs in transit;
- Power surges or overheating due to external conditions
- Acts of nature including but not limited to lightning strikes

ANY IMPLIED WARRANTIES, INCLUDING WITHOUT LIMITATION, THE IMPLIED WARRANTIES OF MERCHANTABILITY AND FITNESS FOR A PARTICULAR PURPOSE SHALL BE LIMITED TO THE DURATION OF THIS LIMITED WARRANTY, OTHERWISE THE REPAIR, REPLACEMENT, OR REFUND AS PROVIDED UNDER THIS EXPRESS LIMITED WARRANTY IS THE EXCLUSIVE REMEDY OF THE CONSUMER, AND IS PROVIDED IN LIEU OF ALL OTHER WARRANTIES, EXPRESS OR IMPLIED. IN NO EVENT SHALL NICOR BE LIABLE, WHETHER IN CONTRACT OR IN TORT (INCLUDING NEGLIGENCE) FOR DAMAGES IN EXCESS OF THE PURCHASE PRICE OF THE PRODUCT, OR FOR ANY INDIRECT, INCIDENTAL, SPECIAL OR CONSEQUENTIAL DAMAGES OF ANY KIND, OR LOSS OF REVENUE OR PROFITS, LOSS OF BUSINESS OR OTHER FINANCIAL LOSS ARISING OUT OF OR IN CONNECTION WITH THE ABILITY OR INABILITY TO USE THE PRODUCT TO THE FULL EXTENT THESE DAMAGES MAY BE DISCLAIMED BY LAW.

This device complies with part 15 of the FCC Rules. Operation is subject to the following two conditions: (1) This device may not cause harmful interference, and (2) this device must accept any interference received, including interference that may cause undesired operation.

NOTE: This equipment has been tested and found to comply with the limits for a Class A digital device, pursuant to part 15 of the FCC Rules. These limits are designed to provide reasonable protection against harmful interference when the equipment is operated in a commercial environment. This equipment generates, uses, and can radiate radio frequency energy and, if not installed and used in accordance with the instruction manual, may cause harmful interference to radio communications. Operation of this equipment in a residential area is likely to cause harmful interference in which case the user will be required to correct the interference at his own expense.

THANK YOU
FOR YOUR PURCHASE

SHARE YOUR EXPERIENCE WITH US

SCAN the QR or visit
www.nicorlighting.com/support/survey

FOLLOW US     YouTube

