

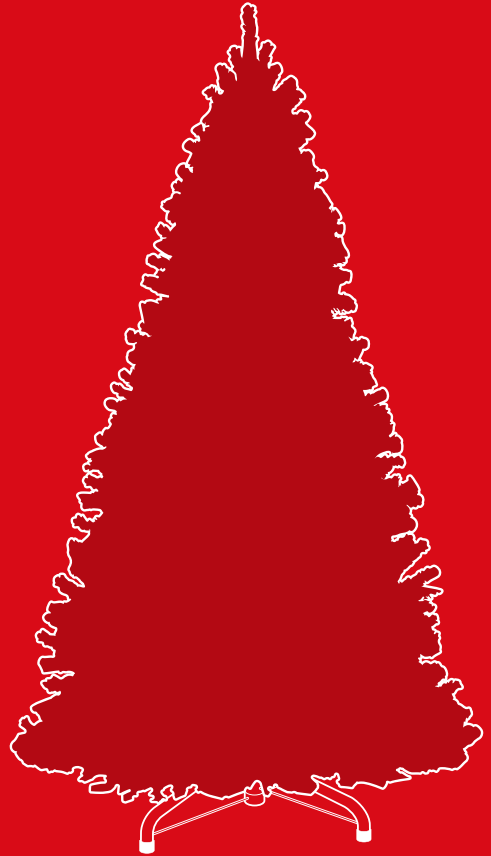

bestchoiceproducts



INSTRUCTION MANUAL

9-Foot Artificial Hinged Christmas Tree



Please remove the circular protector caps on the end of each of the poles before assembling.



bestchoiceproducts.com

HARDWARE

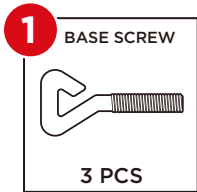

1 PERSON
ASSEMBLY



APPROXIMATELY
15 MIN.
ASSEMBLY

PARTS

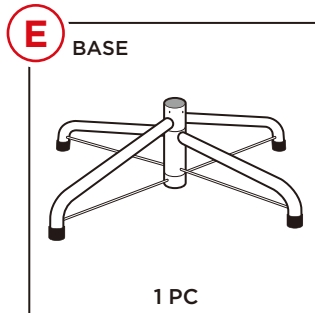
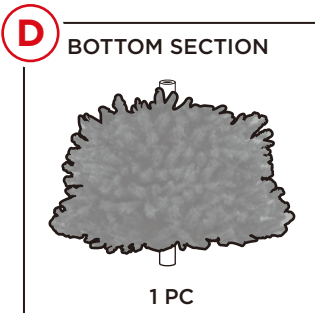
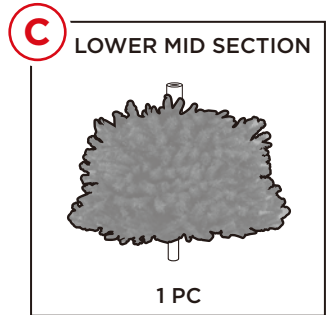
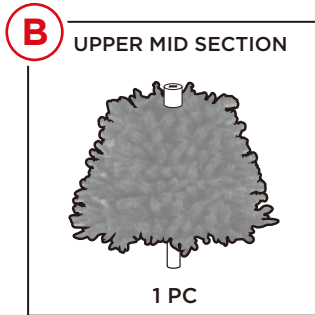
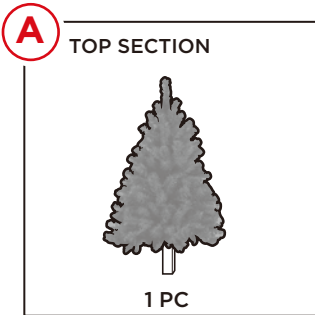

PRODUCT ASSEMBLY

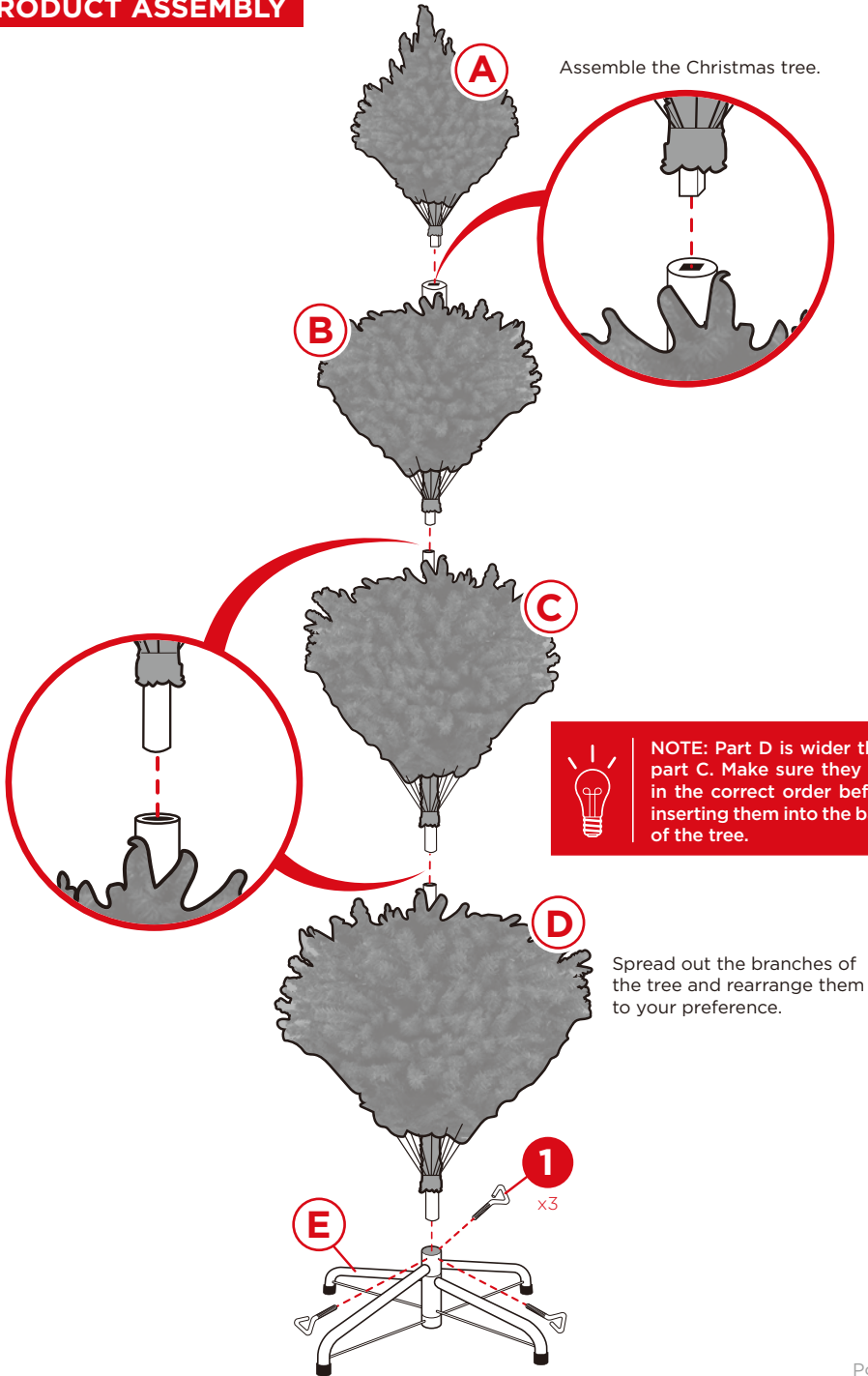

CAUTION



- Firmly secure all screws before use.
- Product is intended for indoor use only.
- Do not place this tree in a wet location.
- This seasonal product is not intended for permanent installation or use.
- Do not use or store this item in the proximity of open flame, flammable/combustible chemicals, or other strong heat sources.
- If any parts are missing, broken, damaged, or worn, stop using this item until repairs are made and/or factory replacement parts are installed.
- Do not use this item in a way that is inconsistent with the manufacturer's instructions as this could void the product warranty.

CLEANING & STORAGE

- Store this tree in a cool and dry place away from heat and moisture.
- Before putting this tree in storage, do the following:
 - Completely remove all decorations.
 - Clean the tree with a slightly damp cloth and let it dry naturally.
 - Raise all branches to original upright position; make sure not to damage any branches in the process.

PRODUCT WARRANTY INFORMATION

All items can be returned for any reason within 60 days of the receipt and will receive a full refund as long as the item is returned in its original product packaging and all accessories from its original shipment are included. All returned items will receive a full refund back to the original payment method. All returned items will not be charged a re-stocking fee.

All returned items require an RA (Return Authorization) number, which can only be provided by a Best Choice Products Customer Service Representative when the return request is submitted. Items received without an RA may not be accepted or may increase your return processing time. Once an item has been received by Best Choice Products, refunds or replacements will be processed within 5 business days.

All returns must be shipped back to the Best Choice Products Return Center at the customer's expense. If the reason for return is a result of an error by Best Choice Products then Best Choice Products will provide a pre-paid shipping label via email. Boxes for return shipping will not be provided by Best Choice Products, and is the customer's responsibility to either use the original shipping boxes or purchase new boxes.

Pictures may be required for some returns to ensure an item is not damaged prior to its return. Items returned are not considered undamaged until they are received by Best Choice Products and verified as such. All damages to items are the customer's responsibility until the item has been received by and acknowledge by Best Choice Products as undamaged.

CONTACT US; WE'RE HERE 7 DAYS A WEEK TO HELP YOU!



bestchoiceproducts.com



customerservice@bestchoiceproducts.com



844.948.8400



LEARN MORE!

WARNING

Manufacturer and seller expressly disclaim any and all liability for personal injury, property damage or loss, whether direct, indirect, or incidental, resulting from the incorrect attachment, improper use, inadequate maintenance, or neglect of this product.