

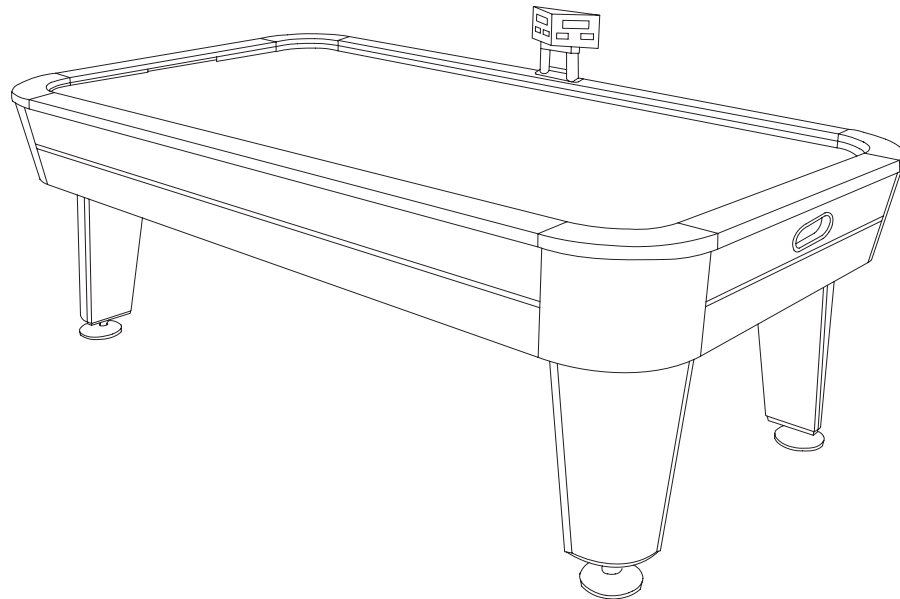

VANCOUVER 7.5 FOOT AIR POWERED HOCKEY TABLE



Replacement Parts

Order direct at www.gldproducts.com
or call our Customer Service department at
(800) 225-7593
8 am to 4:30 pm Central Standard Time

GLD Products

**Vancouver Air Powered
Hockey Table**

Item 64-3008

Staple your receipt here.

Important: A copy of your receipt will be needed to activate your warranty (see page 7).

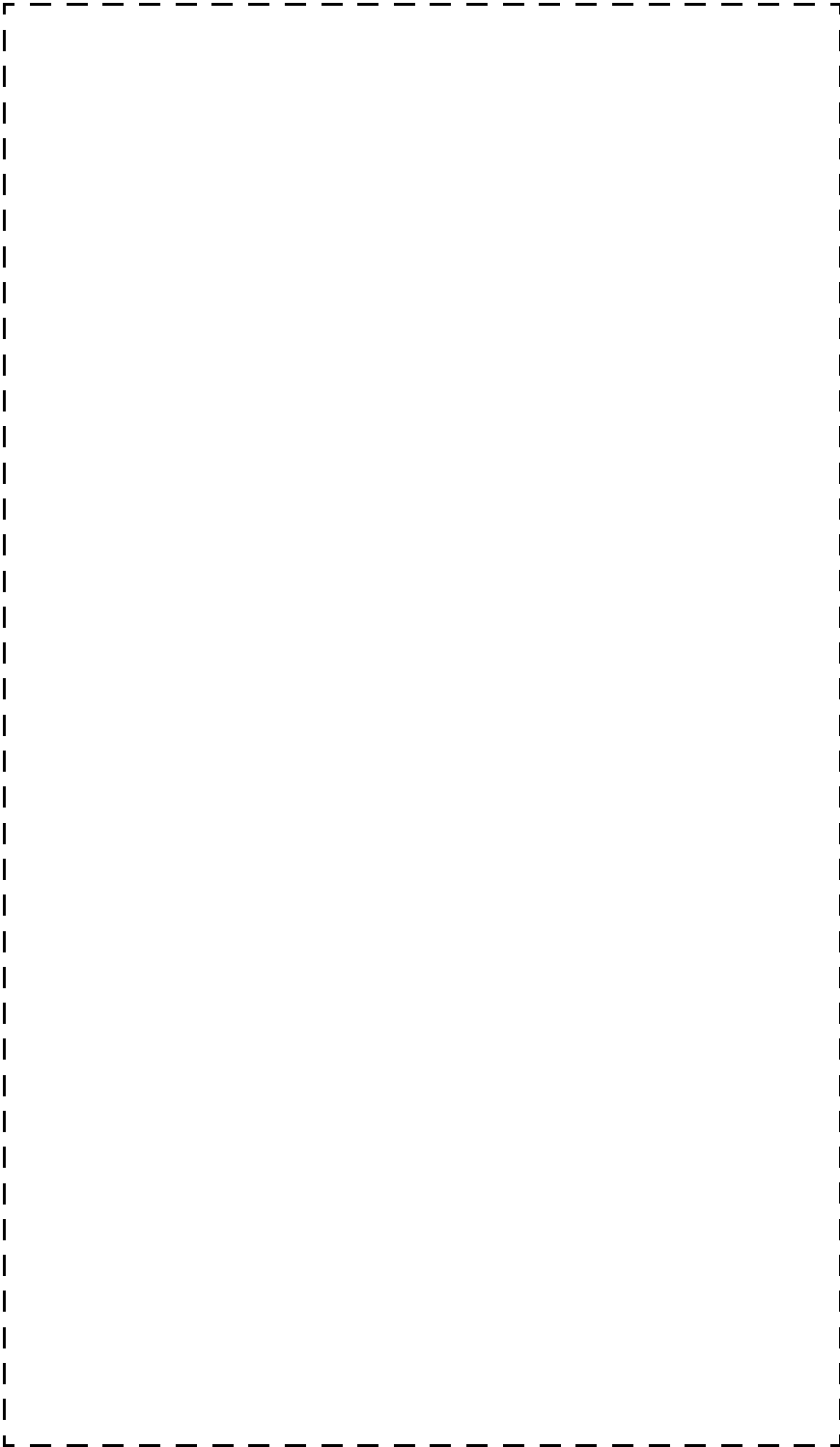



Congratulations and THANK YOU for purchasing the Vancouver Air Powered Hockey Table. You have chosen a product that should provide years of entertainment. To assist you with customer service and warranty claims, staple your receipt to the inside cover, then keep this manual in a safe place for future reference.











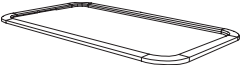
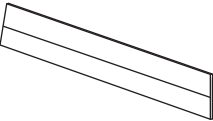
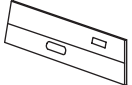
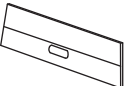

GLD Products

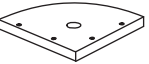
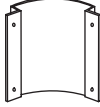

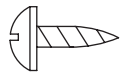
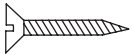

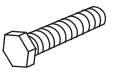

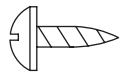
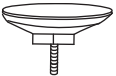
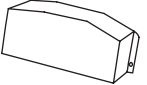
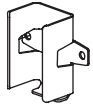
S84 W19093 Enterprise Drive
Muskego, WI 53150 USA
1-800-225-7593
Fax: 1-800-841-6944
Email: gld@gldmfg.com
Web: www.gldproducts.com

This manual may have been updated. For the latest manual visit the GLD Products website.

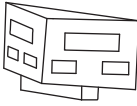
	<p>Place your package near the location where it will be used. Carefully unpack all components and verify you have all the correct pieces.</p> <p>If you notice missing or defective parts, please call us at: 1-800-225-7593.</p>
---	---

	<p>Please read and understand all instructions before beginning assembly.</p> <p>This assembly will require 2 adults.</p> <p>This product is not for use by children without adult supervision.</p>
---	--

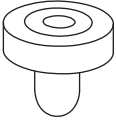
Part No./ Qty	Illustration/ Order Number	Part No./ Qty	Illustration/ Order Number	Part No./ Qty	Illustration/ Order Number
1 Qty. 1	 TableTop Order No. 64-3008-30	2 Qty. 2	 Side Apron Order No. 64-3008-1	3 Qty. 1	 End Apron - A Order No. 64-3008-2
4 Qty. 1	 End Apron - B Order No. 64-3008-3	5 Qty. 4	 Leg Panel - A (notched) Order No. 64-3008-4	6 Qty. 4	 Leg Panel - B Order No. 64-3008-5
7 Qty. 4	 Rounded Leg Panel - C Order No. 64-3008-6	8 Qty. 4	 Leg Base Order No. 64-3008-7	9 Qty. 4	 Apron Corner Order No. 64-3008-8
10 Qty. 12	 Wing Bolt 1/4" x 3/4" Order No. 64-3008-9	11 Qty. 26	 T4 x 12 mm Pan Head Screw Order No. 2-31	12 Qty. 32	 F4 x 1-3/4" Countersunk Screw Order No. 64-3008-11
13 Qty. 24	 F4 x 1-1/4" Countersunk Screw Order No. 2-60	14 Qty. 16	 5/16" x 2-1/2" Hex Bolt Order No. 64-3008-13	15 Qty. 32	 5/16" x 19 mm Flat Washer Order No. 1-90
16 Qty. 16	 5/16" Hex Nut Order No. 2-139	17 Qty. 4	 T4 x 15 mm Pan Head Screw Order No. 2-174	18 Qty. 4	 5/16" Leg Leveler Order No. 64-3008-17
19 Qty. 2	 Puck Return Box Order No. 64-3008-18	20 Qty. 1	 "U" Bracket Order No. 64-3008-19	21 Qty. 1	 Control Box Order No. 4-104

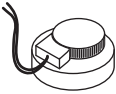
<p>22</p> <p>Qty. 1</p>  <p>Adapter Order No. 4-101</p>	<p>23</p> <p>Qty. 1</p>  <p>Electronic Scoreboard Order No. 64-3008-22</p>	<p>24</p> <p>Qty. 2</p>  <p>Short Pole Order No. 64-3008-23</p>
<p>25</p> <p>Qty. 1</p>  <p>Plastic Scoreboard Base Order No. 64-3008-24</p>	<p>26</p> <p>Qty. 4</p>  <p>Felt Pad Order No. 2-19</p>	<p>27</p> <p>Qty. 4</p>  <p>Goalie Order No. 4-102 (2 - Blue) 4-103 (2 - Black)</p>
<p>28</p> <p>Qty. 4</p>  <p>Round Puck Order No. 4-83</p>	<p>29</p> <p>Qty. 1</p>  <p>Wrench Order No. 1-17</p>	<p>30</p> <p>Qty. 1</p>  <p>Fan Order No. 4-107</p>

IF YOU HAVE A WARRANTY CLAIM, CALL US FIRST

Please see page 19.

GLD Products

Available 8 am to 4:30 pm Central Standard Time

S84 W19093 Enterprise Drive
Muskego, WI 53150 USA
1-800-225-7593
Fax: 1-800-841-6944
Email: gld@gldmfg.com
Web: www.gldproducts.com

For all claims, please have your receipt and item number when you call. The product item number can be found on the front cover.

If you are instructed to return the product for service, you are responsible for shipping the unit at your expense.

PRODUCT REGISTRATION

Important: The product registration form on page 21 and a copy of your receipt must be completed and returned within 10 days of purchase to validate your warranty.

Online registration is also available. Go to <http://gldproducts.com/warranty-information> or click on this link. Follow the online instructions.

Preparing for Assembly

- Be sure to unpack all of the parts included in this package. Check inside any tubes or sleeves. Save all packing material until the product is fully assembled and functional.
- Compare the parts in your package with the Parts Identifier description on page 5.
- After unpacking large products, some disassembly may be required prior to beginning the assembly.

Tools Required

- Open end wrench (#29) - included with table
- Phillips screwdriver (not included)
- Level (not included)
- Electric screwdriver may be helpful. **CAUTION:** You must set at LOW TORQUE and use extreme caution because you could overtighten the hardware, strip the screws, or damage the table.

Assembly Tips

Make sure you understand the following before you begin to assemble your game table.

1. READ THIS MANUAL all the way through before beginning assembly.
2. When installing parts that have more than one bolt, start ALL bolts in that part by hand before tightening anything.
3. Some drawings or images in this manual may not look exactly like your product.
4. You may need a second adult to assist with this assembly.

Note: Save all packing materials until the parts have been inspected and the table is assembled.

Unpack the Pieces

- Lay the box on a flat surface (floor). You may want this near your area of assembly.
- Unpack the boxes and part bags. Inspect and count the parts. The Parts Identifier page can be used to record your results.
- If any parts are damaged or missing, contact GLD Customer Service.
- Missing fasteners may be purchased at a hardware store using the descriptions on the Parts Identifier page.

Games

This game table includes the equipment and game pieces for Air Powered Hockey. The rules for this game are not discussed in this manual.

STEP 1 - ASSEMBLE APRON SIDES

1. The electronic scoreboard (#23) and base (#25) mount on one of the long sides of the table top (#1). Locate the mounting holes.
2. Position the table top (#1) bottom side up on the floor (flat surface). Make note of where the scoreboard mounting holes are.
3. Hold the end apron piece (#3) in place. This is the apron with the hole for mounting the controls (#21). Use wing bolts (#10) to secure the end apron to the table top.
4. Repeat for the remaining three sides.

CAUTION: End apron (#3) must be mounted with the opening for the controls close to the scoreboard or the control wires will not be long enough.

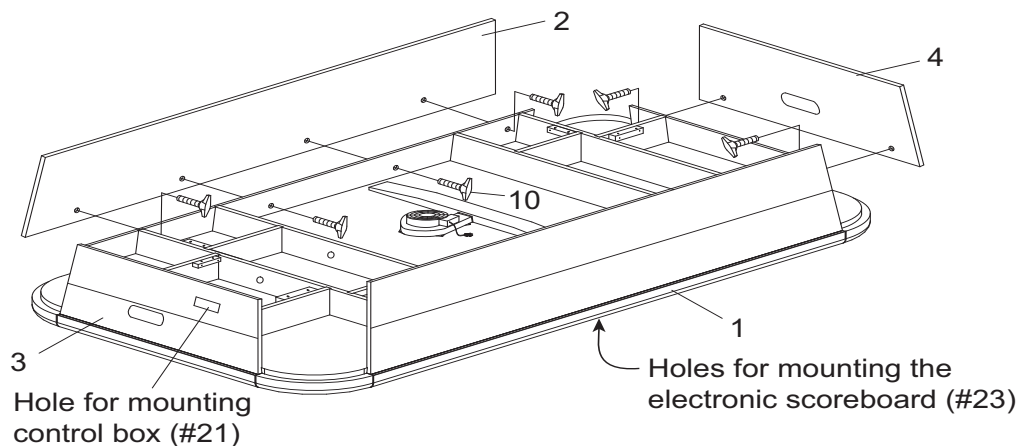

STEP 2 - ASSEMBLE THE CORNERS

1. Position one of the apron corners (#9) with the flanges on the inside of the apron piece.
2. Use four screws (#11) to secure the corner (#9). While tightening the screws hold the corner (#9) to line-up with the apron piece.
3. Repeat for the remaining three sides.
4. Attach the puck return box (#19) by inserting two screws (#11), one in each and tightening. Do not pinch the wires.

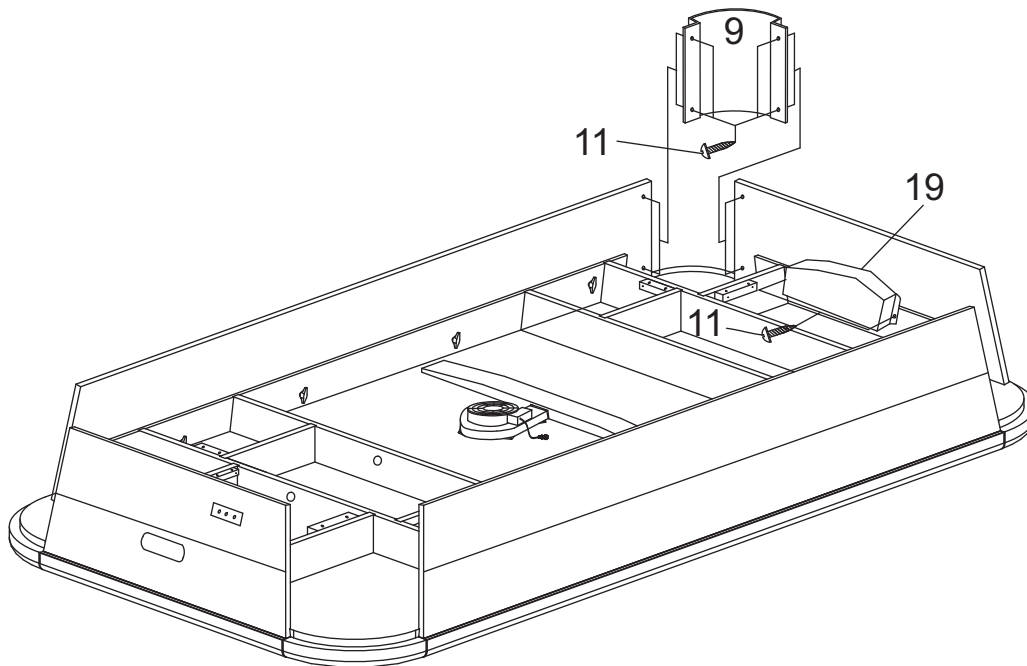

STEP 3 - ASSEMBLE THE LEGS

Each leg has four main pieces. The two leg panels (#5 & #6) are not the same. Leg panel #5 has a notch that leg panel #6 will fit into.

1. Position leg panel (#6) to fit into the notch on leg panel (#5). Use four screws (#12) to hold the two panels together.
2. Hold the rounded leg panel (#7) in place. Use six screws (#13) to secure the leg pieces together.
3. Turn the leg assembly so the bottom (small end) is up. Position the leg base (#8) and use four screws (#12) to secure it to the leg assembly.

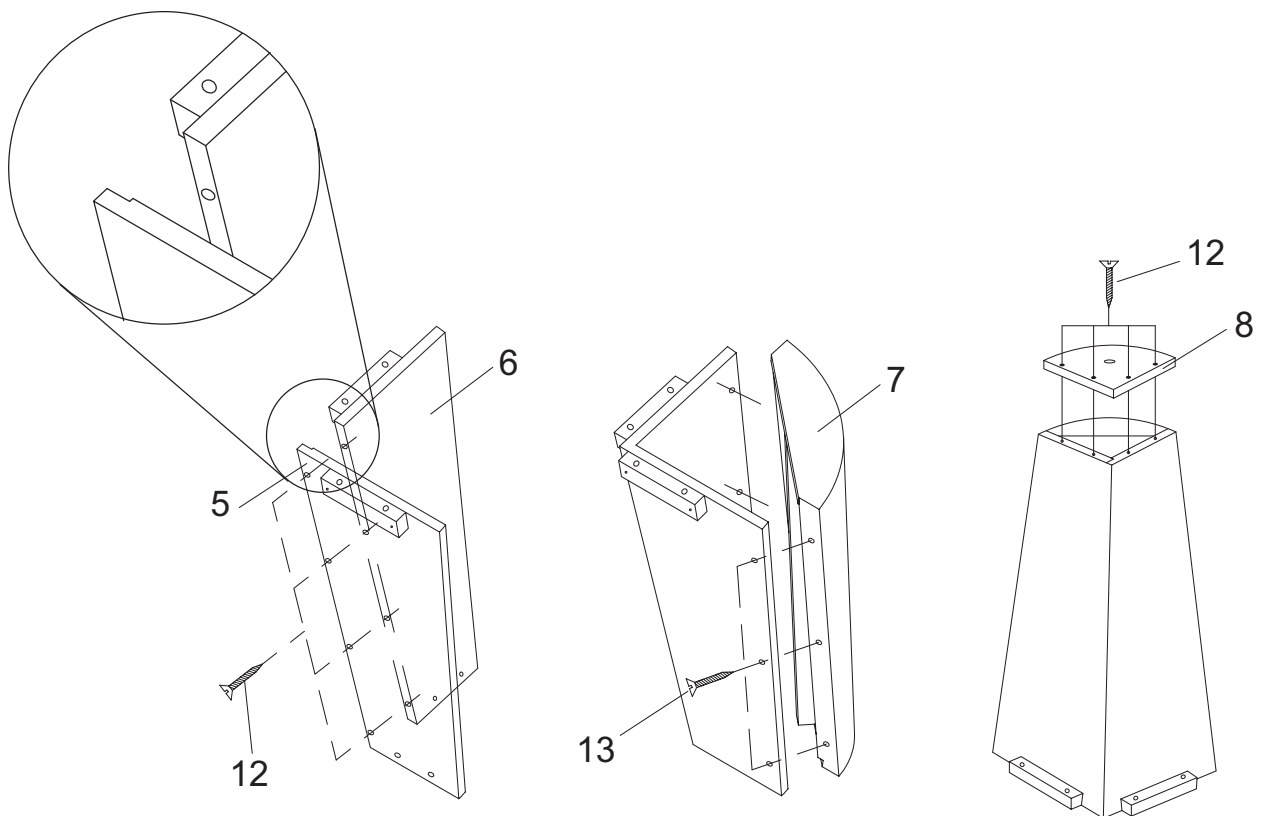

STEP 4 - ATTACH THE LEGS

All of the leg assemblies are the same.

1. Position a leg assembly so the two wooden blocks are matched up.
2. Insert two bolts (#14) and washers (#15) into both blocks. Hold a washer (#15) and a nut (#16) below the bottom block while tightening the bolt (#14).

NOTE: Some tables may use a metal flange in place of a nut (#16). These tables will have the flange already attached. The bolts (#14) and washers (#15) are then inserted and tightened. A nut is not used.

3. Screw a leg leveler (#18) into the center hole of the leg base (#8). The leveler (#18) is screwed half-way in.
4. Repeat for the remaining three legs.

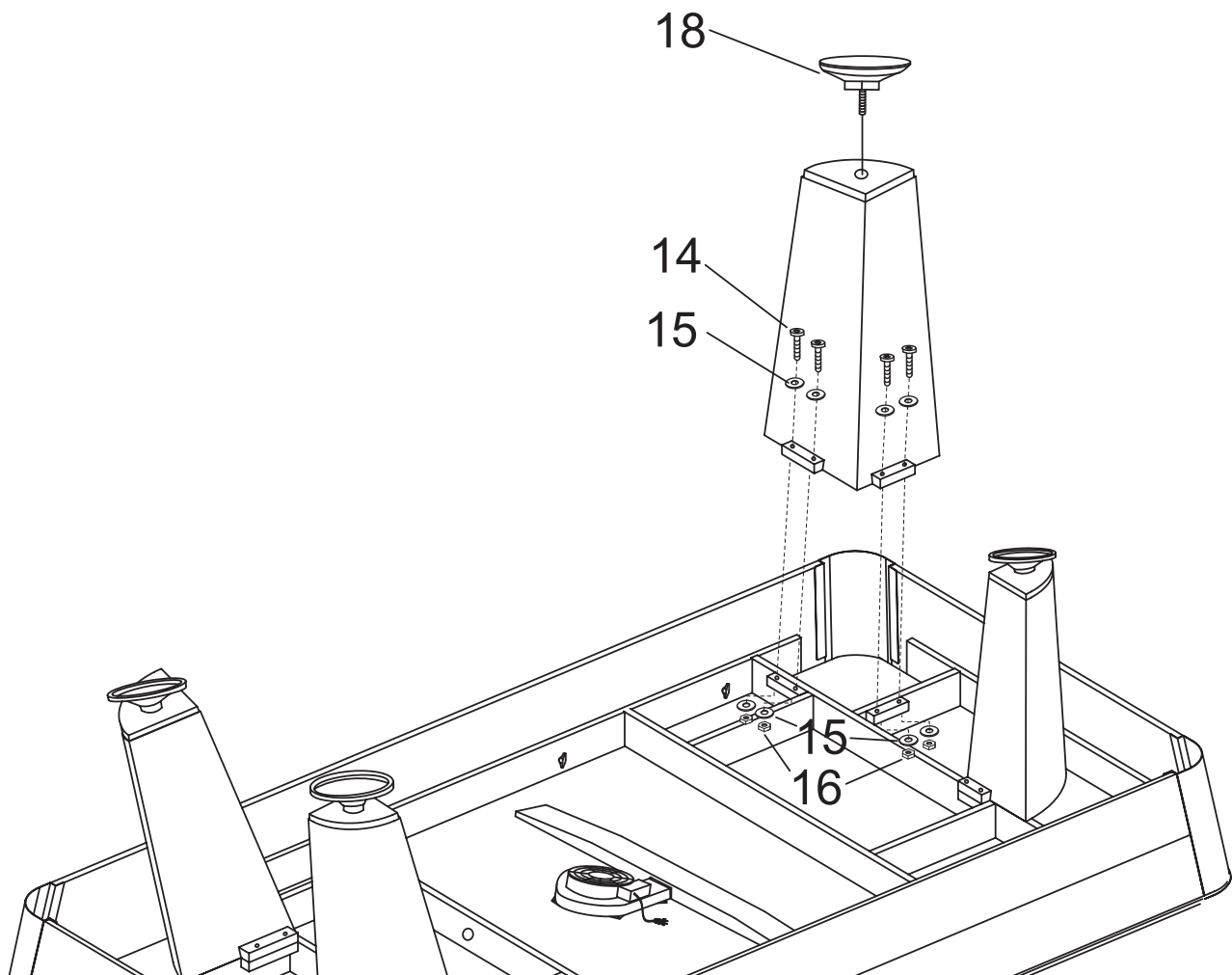

STEP 5 - INSTALL ELECTRIC COMPONENTS

1. Lay the control box (#21) next to the opening.
2. Route the puck return box (#19) wires through the openings in the table cross braces and through the opening for the control box. Plug them into the control box (#21). See illustration for correct locations.
3. The table outlet is connected to the control box (#21). A "U" bracket (#20) is supplied to hold the table outlet. Mount the "U" bracket (#20) from the underside of the table next to the opening for the control box (#21). Note that the "U" bracket (#20) has a top and bottom. Hold the "U" bracket (#20) with the leg on the end toward the bottom side of the apron (remember that the table will be turned over). Use two screws (#11) to secure the "U" bracket.
4. Insert the table outlet into the "U" bracket (#20).
5. Route the fan wire to the table outlet and plug in. Do not screw the control box (#21) to the apron at this time.
6. When the table outlet is secure, plug the power adapter into it. The output wire can be routed through the opening and plugged into the control box.

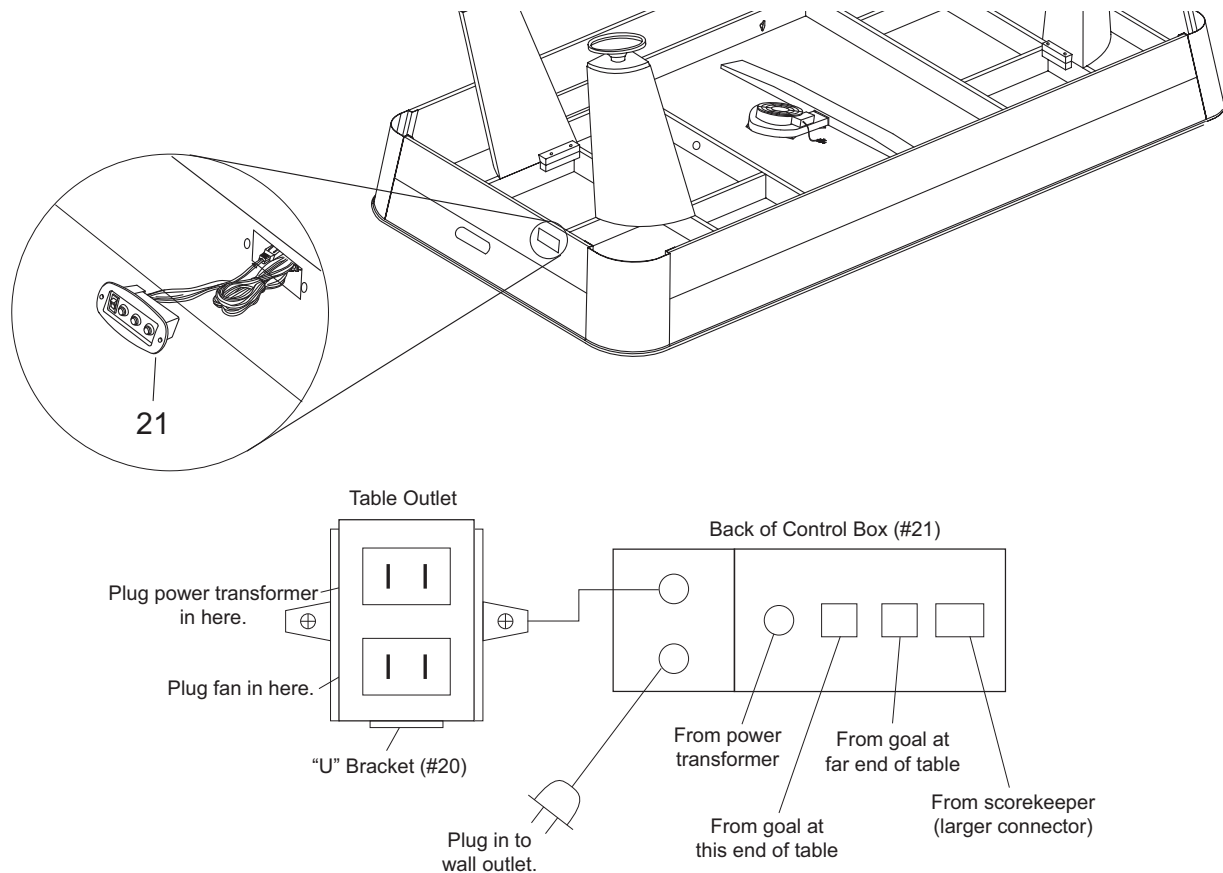

STEP 6 - TURN THE TABLE OVER

The table is ready to be turned over.

USE AT LEAST TWO PEOPLE TO LIFT THE TABLE ASSEMBLY AND TURN IT OVER TO REST ON THE LEGS.

DO NOT ROLL THE TABLE OVER. This will place a sideways force on the legs. The legs should be off the floor until the table assembly is rotated completely. Set the table down.

DO THIS

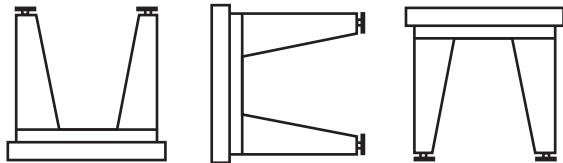

NOT THIS

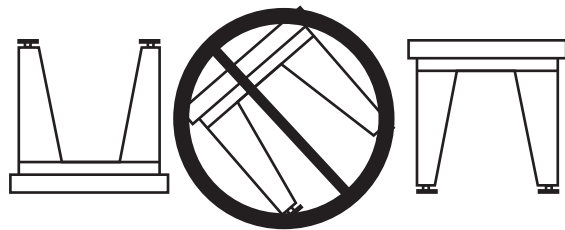

STEP 7 - MOUNT THE SCOREBOARD

1. Insert the two short poles (#24) into the scoreboard base (#25). Rotate to line up the screw holes and use a screw (#11) to secure each one.
2. Feed the control wire for the scoreboard (#23) through one of the assembled short poles. Pull the additional wire through until the two poles (#24) are pushed into the scoreboard (#23). Use two screws (#11) to secure the pole (#24) into the scoreboard (#23).
3. Feed the control wire into the hole on the table edge. Pull the extra wire through and position the scoreboard assembly. The scoreboard (#23) should face the table.
4. Use two screws (#17) and secure the scoreboard assembly to the table top. Under the table, route the scoreboard control wire to the control box opening. Plug the wire into the control box (#21).
5. Move all of the wires from the control box (#21) through the hole in the apron. Position the control box in the hole with the text right-side up.
6. Use two screws (#17) to mount the control box (#21).

CAUTION: When pushing the wires through the hole be careful to position them away from the leg behind the control box. If wires bunch up and prevent the control box from entering the opening, connections may be damaged.

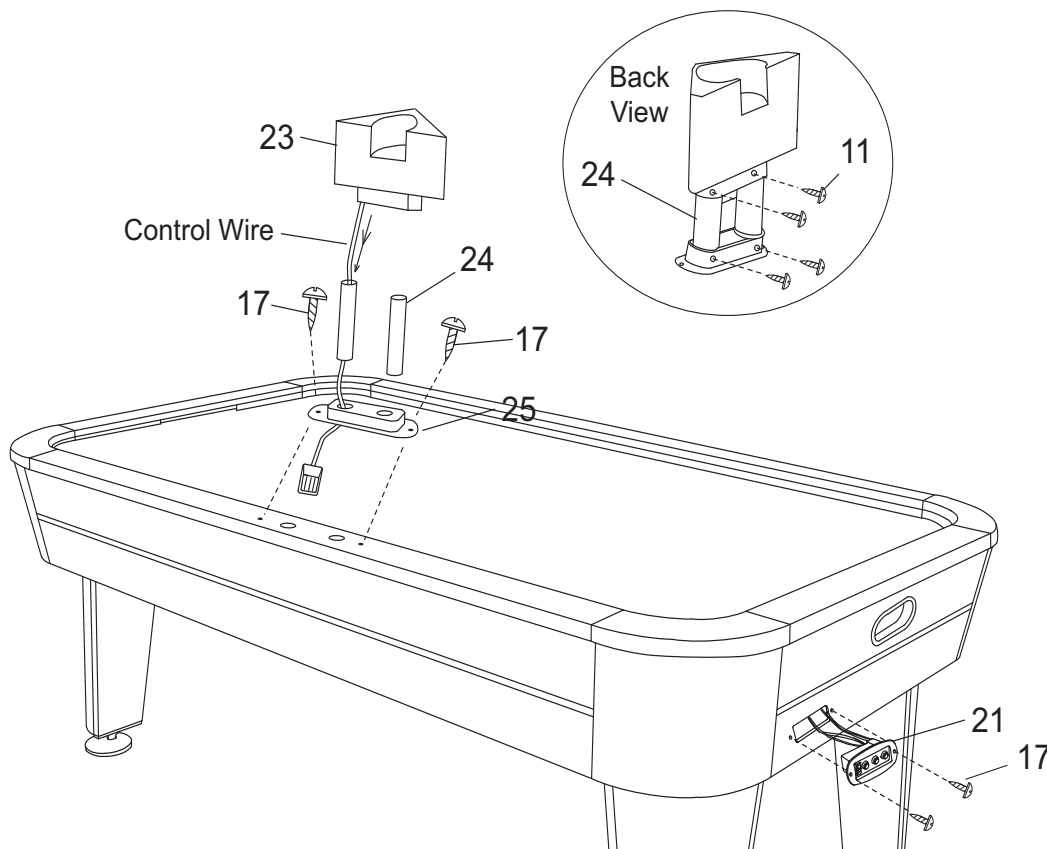

STEP 8 - OPERATION

1. Test the score keeping system by pressing the main power switch and the scoreboard switch ON. The scoreboard and fan will turn on. One window displays the time remaining the other window displays both the home and visitor scores.
2. Push a puck (#28) into a goal with the scoreboard turned ON. The score will display as either home or visitor. The two wires from the goals can be switched at the control box under the table top. Switching these wires will reverse which goal scores for the home and visitor teams. Turn the game off by pressing the two power buttons to OFF.
3. Press the minutes button to change the length of a game.

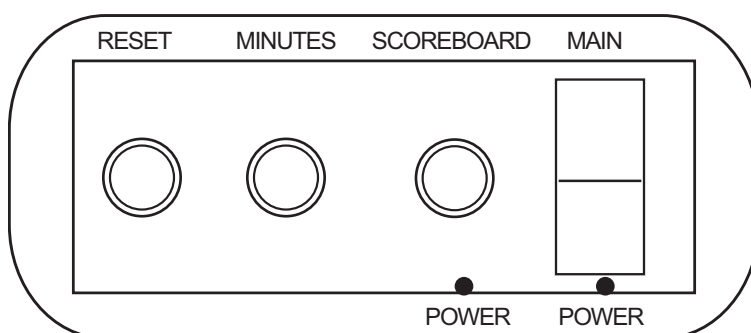
**STEP 9 - LEVEL THE TABLE**

1. Place the table in position.
2. Use a carpenter's level to find the low side of the table.
3. Raise or lower the leg levelers as needed to level the table.
4. Level the table side-to-side and end-to-end. When the game is turned on, the puck will float to a low side. Final leveling can be performed if needed.

STEP 10 - ASSEMBLE GOALIE

1. Peel paper from one of the hockey felt pieces (#26).
2. Attach the felt to the bottom of the goalie (#27).

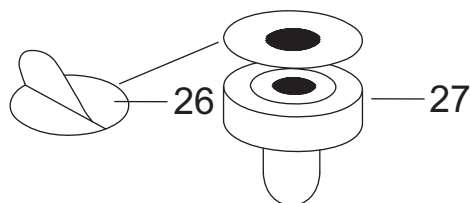

Care and Use of your Table

- This product is intended for INDOOR use only.
- DO NOT sit, climb, or lean on the table.
- DO NOT drag the table when moving it. This will damage the legs.
- Keep your table covered.
- To clean the hard surfaces spray a cloth with a mild cleaner and wipe.
- Pucks that fly off the table may have chipped edges. Inspect the puck and replace if needed.
- The air holes may become plugged, causing the puck to drag. A small drill bit can be used to re-open the holes. DO NOT use a power drill. Instead, hold the drill bit in your fingers and clear the holes.

90-DAY LIMITED WARRANTY

The Manufacturer warrants to the original retail purchaser that this product is free from defects in material and workmanship under normal use and conditions for a period of ninety (90) days from the date of original purchase. The Manufacturer's liability is limited to the repair or replacement, at its option, of any defective product and shall not include any liability for indirect, incidental or consequential damages of any kind. Should this product become defective due to material or workmanship within the warranty period, contact our Customer Service Department. This warranty is not transferable and does not cover normal wear and tear or damage caused by improper usage, negligence, misuse, abuse, transportation damage, acts of nature, or accident (including failure to follow the instructions in this manual). It does not cover expendable items such as batteries, light bulbs, fuses, accessories, cosmetic parts and other items that wear out due to normal usage, including felt covered areas of the playing surface. This warranty is also void if the product is disassembled and reassembled, damaged, modified from its original state, or used for other than indoor personal residential use (no commercial or rental applications).

This warranty gives you specific legal rights, and you may have other rights which vary from state to state.

IF YOU HAVE A WARRANTY CLAIM, CALL US FIRST (8 - 4:30 CST)

Please have your receipt and item number (found on the front cover) when you call.

GLD Products

S84 W19093 Enterprise Drive
Muskego, WI 53150 USA
1-800-225-7593
Fax: 1-800-841-6944
Email: gld@gldmfg.com
Web: www.gldproducts.com

If you are instructed to return the product for service, you are responsible for shipping the unit at your expense to the above address in packaging that will protect against further damage. All warranty or repair requests require a Return Authorization Number prior to returning the item.

PRODUCT REGISTRATION

Important: The product registration form on page 21 must be completed and returned along with a copy of your receipt within 10 days of purchase to validate your warranty.

Online registration is also available. Go to <http://gldproducts.com/warranty-information> or click on this link. Follow the online instructions.

REGISTER YOUR PRODUCT

Place postage here

Complete this form, include a copy of your receipt, fold, tape (do not staple) and return within 10 days of purchase. This protects your warranty and will help us develop new products!

Cut here.

GLD Products
 Warranty Department
 S84 W19093 Enterprise Drive
 Muskego, WI 53150 USA

Fold here second.



P R O D U C T S

www.gldproducts.com

- | | |
|-----------------------|----------------------------|
| GAME TABLES | HOME CASINO |
| GAMES AND ACCESSORIES | BILLIARD CUES |
| BILLIARD ACCESSORIES | DARTBOARDS |
| SOFT-TIP DARTS | STEEL-TIP DARTS |
| FLIGHTS AND SHAFTS | DART CASES AND ACCESSORIES |

Fold here first.

Name	Date of Purchase
Address	Phone-Day
City	Phone-Evening
State Zip	Email
Purchase Price:	Item: 64-3008 Vancouver Air Powered Hockey Table
Store Name:	

1. What are the top two reasons that influenced the purchase of this product? Select two.

- | | | | |
|--------------------------|-------------------------|--------------------------|---|
| <input type="checkbox"/> | Brand reputation | <input type="checkbox"/> | Prior experience with another GLD product |
| <input type="checkbox"/> | Saw in an advertisement | <input type="checkbox"/> | Color/appearance |
| <input type="checkbox"/> | Quality/durability | <input type="checkbox"/> | Other |
| <input type="checkbox"/> | Value for price | | |

2. How did you become aware of this product? Select two.

<input type="checkbox"/>	Saw in an advertisement	<input type="checkbox"/>	Saw it in the store
<input type="checkbox"/>	Saw or used a friend's or relative's	<input type="checkbox"/>	Recommended by another person
<input type="checkbox"/>	Received as a gift	<input type="checkbox"/>	Other

3. Rate your satisfaction with each of the following?

	Excellent	Good	Fair	Poor
Assembly instructions				
Ease of assembly				
Packaging				
Overall product satisfaction				

4. Were there any parts missing?

Yes No If so, which ones? Order No. _____

5. Based on your experience, would you buy another GLD product?

Yes No

6. Is this the first GLD product that you've owned? If No, what other product have you owned?:

Yes No _____

7. Have you owned products from:

Sportcraft Harvard Classic Sport Other

8. When did you decide to purchase this product?

Before entering the store. While in the store/impulse purchase

9. How many times per month will you use it?

1 to 3 4 to 8 9 to 15 16 +

10. Are you the intended user of this product?

Yes No, indicate who: _____

11. Where will you use this product?

Home Other: _____

12. Please tell us your gender?

Male Female

13. And your marital status?

Married Single

14. Age?

Under 25 25 - 40 40 - 60 Over 60

15. Which best describes your family income?

<input type="checkbox"/>	Under \$25,000	<input type="checkbox"/>	\$25,000 - \$49,999	<input type="checkbox"/>	\$50,000 - \$99,999
<input type="checkbox"/>	\$100,000 - 149,999	<input type="checkbox"/>	\$150,000 - \$199,999	<input type="checkbox"/>	Over \$200,000

16. Education:

<input type="checkbox"/>	Some high school	<input type="checkbox"/>	College degree
<input type="checkbox"/>	Completed high school	<input type="checkbox"/>	Graduate degree

Remember to attach a copy of your receipt.

Mail To: GLD Products
 S84 W19093 Enterprise Drive
 Muskego, WI 53150 USA
 1-800-225-7593 • FAX 800-841-6944
 Email: gld@gldmfg.com
 Web Site: www.gldproducts.com

Vancouver Air Powered Hockey Table

Item 64-3008

Parts Re-Order Form

Name		Date
Address		Phone-Day
City		Phone-Evening
State	Zip	Email

Order No.	Description	Unit Price (each)	Qty.	Total Amount
64-3008-30	Table Top	350.00		
64-3008-1	Side Apron	30.00		
64-3008-2	End Apron - A	20.00		
64-3008-3	End Apron - B	20.00		
64-3008-4	Leg Panel - A (notched)	15.00		
64-3008-5	Leg Panel - B	15.00		
64-3008-6	Rounded Leg Panel - C	15.00		
64-3008-7	Leg Base	5.00		
64-3008-8	Apron Corner	10.00		
64-3008-9	Wing Bolt 1/4" x 3/4"	1.00		
2-31	T4 x 12 mm Pan Head Screw	0.20		
64-3008-11	F4 x 1-3/4" Countersunk Screw	0.20		
2-60	F4 x 1-1/4" Countersunk Screw	0.20		
64-3008-13	5/16" x 2-1/2" Hex Bolt	2.00		
1-90	5/16" x 19 mm Flat Washer	0.20		
2-139	5/16" Hex Nut	0.20		
2-174	T4 x 15 mm Pan Head Screw	0.20		
64-3008-17	5/16" Leg Leveler	10.00		
64-3008-18	Puck Return Box	15.00		
64-3008-19	"U" Bracket	5.00		
4-104	Control Box	15.00		
4-101	Adapter	15.00		
64-3008-22	Electronic Scoreboard	25.00		
64-3008-23	Short Pole	4.00		
64-3008-24	Plastic Scoreboard Base	5.00		
2-19	Felt Pad	1.00		
4-102	Goalie Blue	6.00		
4-103	Goalie Black	6.00		
4-83	Round Puck	1.50		
1-17	Wrench	1.50		
4-107	Fan	25.00		
		Subtotal		
Shipping will be added. If paid by Check or Money Order, call for quote.		S/H		
5.1% Waukesha Wisconsin tax will apply (subject to change).		Tax		
		Total		

Method of Payment

_____ Check or Money Order
_____ Credit Card

_____ Visa _____ MasterCard _____ Discover _____ American Express

Card # _____

Security Code # _____ Billing Address Zip code _____

Signature _____ Exp. Date _____

Shipping Address

Name _____

Address _____ Phone _____

City _____ State _____ Zip _____

GLD[®]

P R O D U C T S

www.gldproducts.com

GAME TABLES

HOME CASINO

GAMES AND ACCESSORIES

BILLIARD CUES

BILLIARD ACCESSORIES

DARTBOARDS

SOFT-TIP DARTS

STEEL-TIP DARTS

FLIGHTS AND SHAFTS

DART CASES AND ACCESSORIES



PROUD MANUFACTURER OF



S84 W19093 Enterprise Drive • Muskego, WI 53150 USA
262.679.8730 or 1.800.225.7593 tele
262.679.8738 or 1.800.841.6944 fax
262.679.8739 international fax
Email: gld@gldmfg.com
www.gldproducts.com