

Features

- Designed in collaboration with Studio McGee
- A single handle controls both on/off activation and temperature setting
- Includes shower arm and flange
- Requires valve (sold separately)
- Coordinates with other products in the Castia collection

Material

- Premium material construction with metal handle ensures reliability and durability
- KOHLER finishes resist corrosion and tarnishing

Required Products/Accessories

K-8304 Series Rite-Temp® Valve & Cartridge Kits

or

K-8300 Series Rite-Temp® Valve Body Rough-ins

K-8305 Series Rite-Temp® Cartridges

Optional Products/Accessories

K-10350 Deep rough-in kit

K-10351 Test cap for K-8300 Series valve bodies

1307346 Retro mixer cap for K-304 Rite-Temp valve

1362395 Retro mixer cap for K-2971 HiFlow Rite-Temp valve

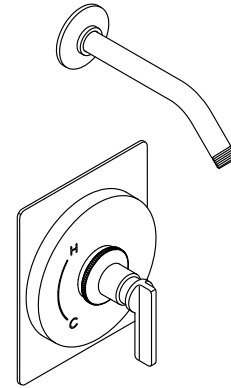

Codes/Standards





ASME A112.18.1/CSA B125.1

KOHLER® Faucet Lifetime Limited Warranty

See website for detailed warranty information.

Available Colors/Finishes

Color tiles intended for reference only.

| Color | Code | Description |
|---|------|--------------------------------|
|  | CP | Polished Chrome |
|  | SN | Vibrant® Polished Nickel |
|  | BN | Vibrant® Brushed Nickel |
|  | BL | Matte Black |
|  | 2MB | Vibrant® Brushed Moderne Brass |

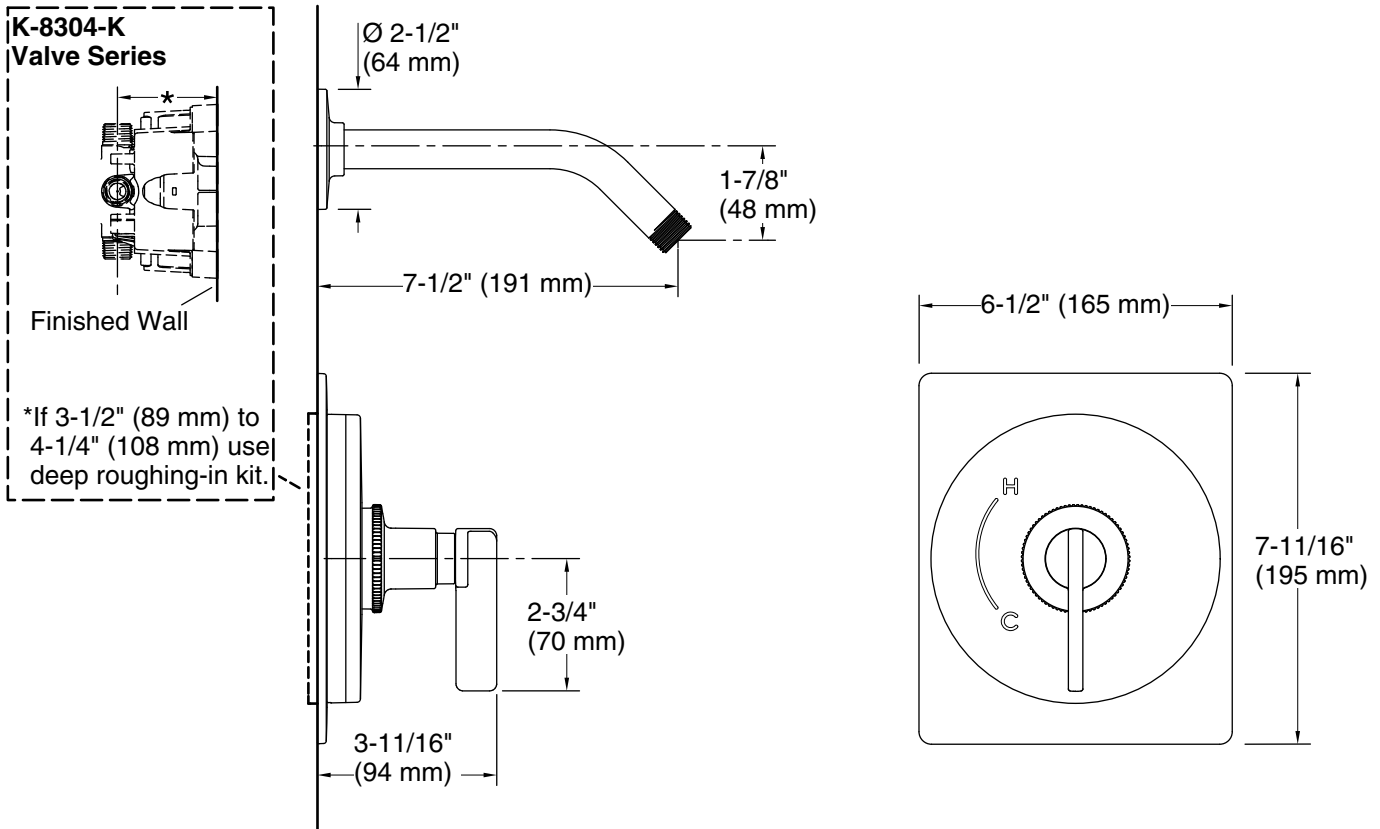

Technical Information

All product dimensions are nominal.

Spout:

Spout reach: 7-1/2" (191 mm)

Notes

Install this product according to the installation instructions.