

Features

- A single handle controls both on/off activation and temperature setting
- Trim includes push button diverter
- Includes single-function 2.5 gpm (9.5 lpm) showerhead with Katalyst® air-induction technology
- MasterClean™ sprayface features an easy-to-clean surface that withstands mineral buildup and maximizes spray performance
- Complements Purist faucets and accessories
- Rite-Temp® pressure-balancing technology maintains water temperature within +/- 3°F

Material

- Premium material construction for durability and reliability
- KOHLER finishes resist corrosion and tarnishing

Installation

- Trim only; requires valve to complete installation (sold separately)

Required Products/Accessories

K-11748 Series Rite-Temp® Valves

Optional Products/Accessories

1016154 Rite-Temp® Deep Rough-In
88526 Thin Wall Trim Kit



Codes/Standards









ASME A112.18.1/CSA B125.1
DOE - Energy Policy Act 1992
NOM Standards
NOM 012-CONAGUA

KOHLER® Faucet Lifetime Limited Warranty

See website for detailed warranty information.

Available Colors/Finishes

Color tiles intended for reference only.

Color	Code	Description
	CP	Polished Chrome
	SN	Vibrant® Polished Nickel
	BN	Vibrant® Brushed Nickel
	BV	Vibrant® Brushed Bronze
	BL	Matte Black
	2MB	Vibrant® Brushed Moderne Brass
	BGP	Vibrant Brushed Graphite
	TT	Vibrant Titanium

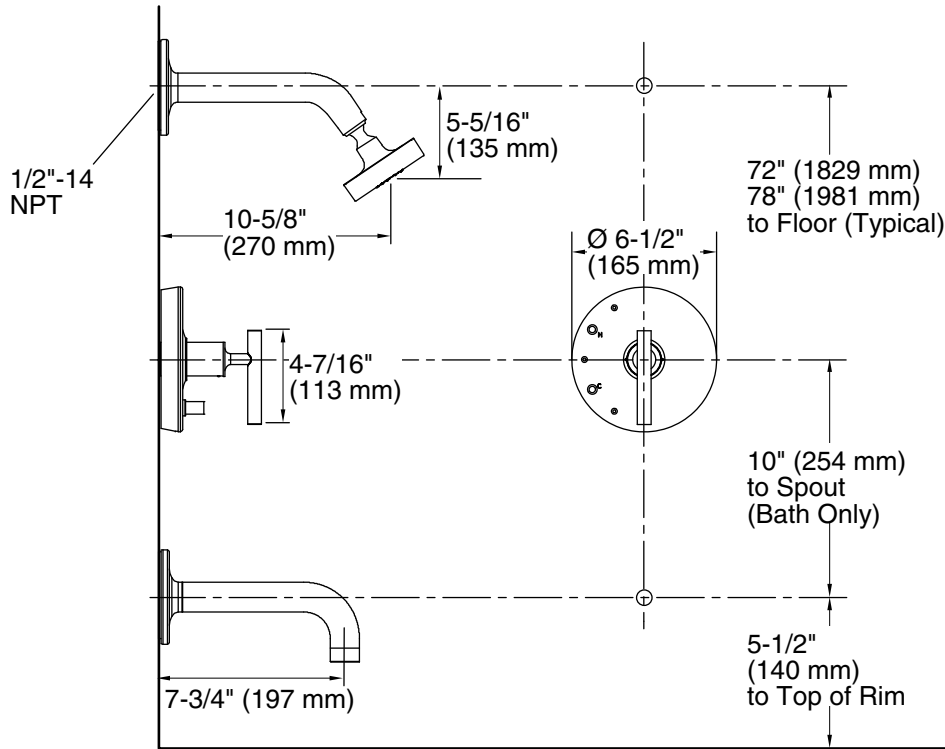

Technical Information

All product dimensions are nominal.

Spout:

Spout reach: 7-3/4" (198 mm)

Handshower rated max flow: 2.5 gal/min (9.5 l/min)

Shower/Rainhead rated max flow: 2.5 gal/min (9.5 l/min)

Notes

Install this product according to the installation guide.

Avoid cross-flow conditions. Do not install shut-off device on either valve outlet.

Cap the shower outlet if deck-mount spout, diverter, or handshower is connected to the spout outlet.