

PRODUCT SPECIFICATIONS

Circuit Chef® Workstation Stainless Steel 32-1/2" x 20-1/2" x 10" Single Bowl Undermount Sink Kit w/ Cherry Wood Boards. Sink is manufactured from 16 gauge 304 Stainless Steel with a Stainless Steel (S) finish, Rear Right drain placement, and Sides and Bottom pads.

Installation Type:	Undermount, Sink Kits
Material:	304 Stainless Steel
Special Features:	Workstation
Finish:	Stainless Steel (S)
Gauge:	16
Sound Deadening:	Sides and Bottom pads
Number of Bowls:	1
Sink Dimensions:	32-1/2" x 20-1/2" x 10"
Bowl 1 Dimensions:	30" x 18" x 10"
Drain Size:	3-1/2" (89mm)
Drain Location:	Rear Right
Minimum Cabinet Size:	36"
Mounting Hardware:	No
Template Included:	Yes
Cutout Template #:	1000005503

Template is available for download at elkay.com. CAD software will be required to open the template.

Special Note: Reserve Selection products are sold exclusively, in-store and online, through authorized wholesalers. This model requires a custom, deeper cabinet for installation. A minimum of 23 1/2" of space is required for the width of the sink to account for the 1/2" edge reveal, faucet, and backsplash.

Installation Profile:

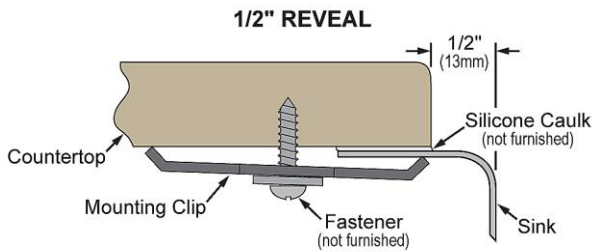

Designed to affix to the underside of any solid surface countertop.



Included with Product: CSSCCW Small Colander, CS30BG Bottom Grid, CS30CW Cherry Wood Cutting Boards, CSLPCW Low Profile Colander, LKDR1718RU Roll Up Drying Rack, LKDD

▼ Ships in multiple boxes.

A Century of Tradition and Quality. For more than 100 years, Elkay has been making innovative products and providing exceptional customer care. We take pride in offering plumbing products that make life easier, inspire change and leave the world a better place.

Product Compliance: ASME A112.19.3/CSA B45.4







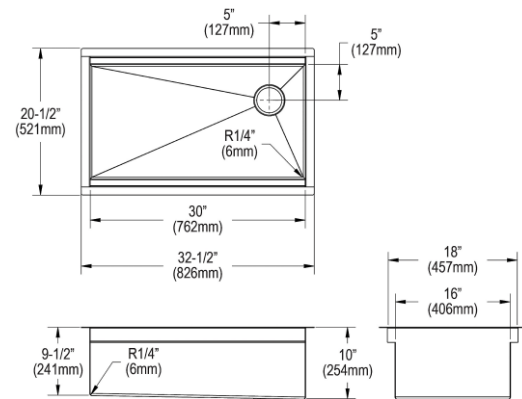

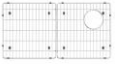

Sinks are listed by IAPMO® as meeting the applicable requirements of the Uniform Plumbing Code®, International Plumbing Code®, and National Plumbing Code of Canada.

[Clean and Care Manual \(PDF\)](#)
[Installation Instructions \(PDF\) - 2000000328](#)
[Warranty \(PDF\)](#)



PART: _____ QTY: _____
 PROJECT: _____
 CONTACT: _____
 DATE: _____
 NOTES: _____
 APPROVAL: _____

In keeping with our policy of continuing product improvement, Elkay reserves the right to change product specifications without notice. Please visit elkay.com for the most current version of Elkay product specification sheets. This specification describes an Elkay product with design, quality, and functional benefits to the user. When making a comparison of other producers' offerings, be certain these features are not overlooked.

Included Accessories		
CS30BG	Circuit Chef® Stainless Steel 29-1/2" x 15-3/8" x 1-3/16" Bottom Grid Spec Sheet (PDF)	
CS30CW	Circuit Chef® Cherry Wood 30-3/4" x 18-3/4" x 3/4" Cutting Boards Spec Sheet (PDF)	
CSLPCW	Circuit Chef® Stainless Steel 17-3/4" x 18-3/4" x 1-1/2" Low Profile Colander with Cherry Wood Handles Spec Sheet (PDF)	
LKDR1718RU	Circuit Chef® Gray Silicone 17-3/4" x 17-5/16" x 3/8" Roll Up Drying Rack Spec Sheet (PDF)	
CSSCCW	Circuit Chef® Stainless Steel 17-3/4" x 8" x 4-1/2" Colander with Cherry Wood Handles Spec Sheet (PDF)	
LKDD	3-1/2" Drain Fitting Deep Strainer Basket Spec Sheet (PDF)	
Optional Accessories		
CSLCCW	Circuit Chef® Stainless Steel 17-3/4" x 11" x 4-1/2" Colander with Cherry Wood Handles Spec Sheet (PDF)	
CSLCCW	Circuit Chef® Stainless Steel 17-3/4" x 11" x 4-1/2" Colander with Cherry Wood Handles Spec Sheet (PDF)	

In keeping with our policy of continuing product improvement, Elkay reserves the right to change product specifications without notice. Please visit elkay.com for the most current version of Elkay product specification sheets. This specification describes an Elkay product with design, quality, and functional benefits to the user. When making a comparison of other producers' offerings, be certain these features are not overlooked.