

2600041 ANIMAL ENCLOSURE XL - TWO DOG Container Loading Diagram

(1 set=5 boxes 46 sets/40HQ, 22 pallets/ 40HQ, Gross Weight: 16548kg)

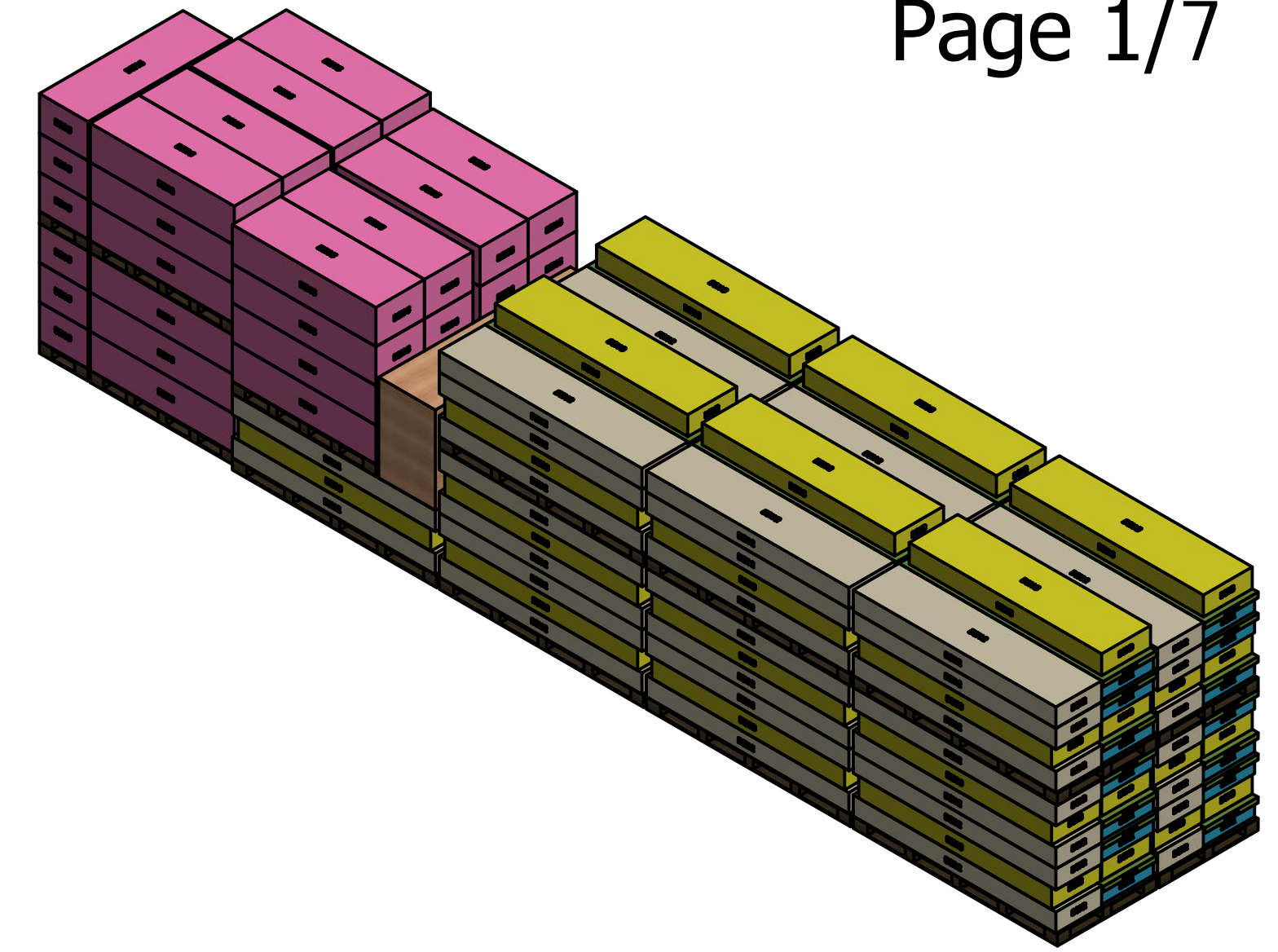

柜子尾部使用塑钢带打交叉带进行固定。

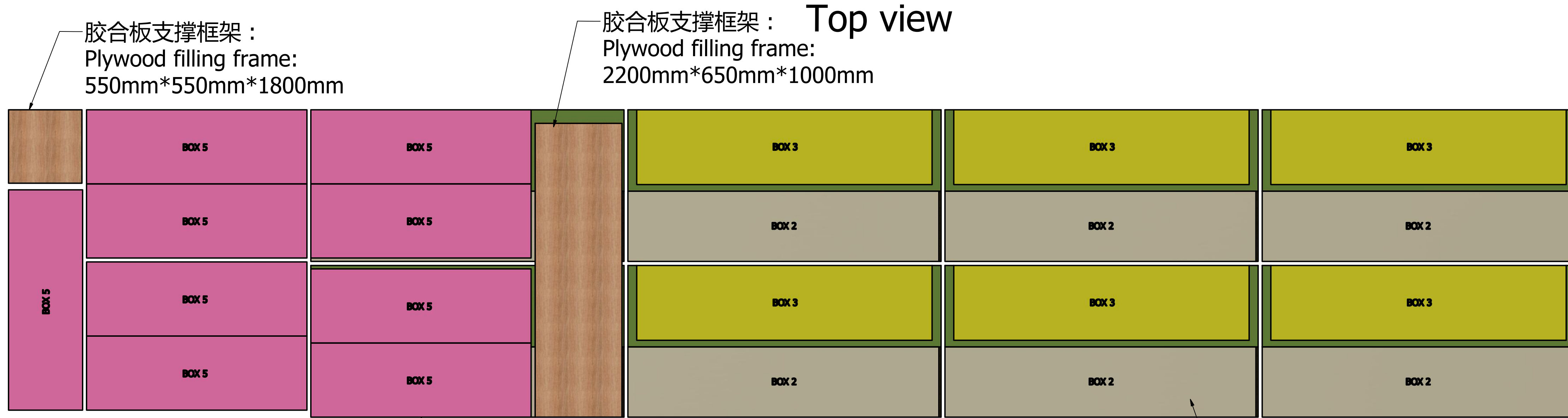

Side view

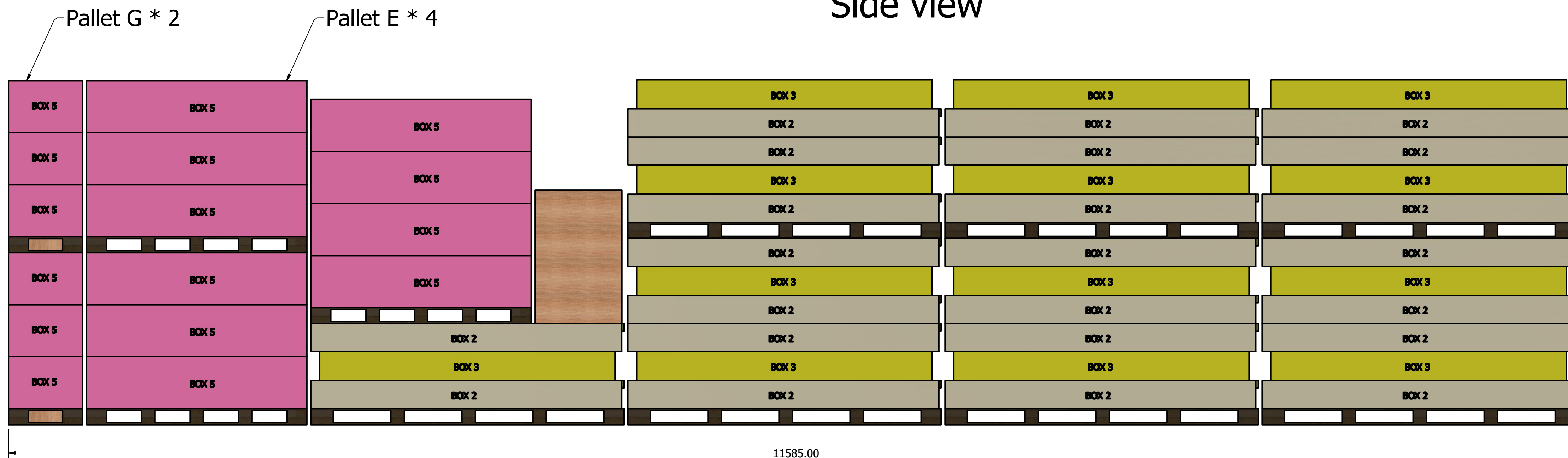

End view

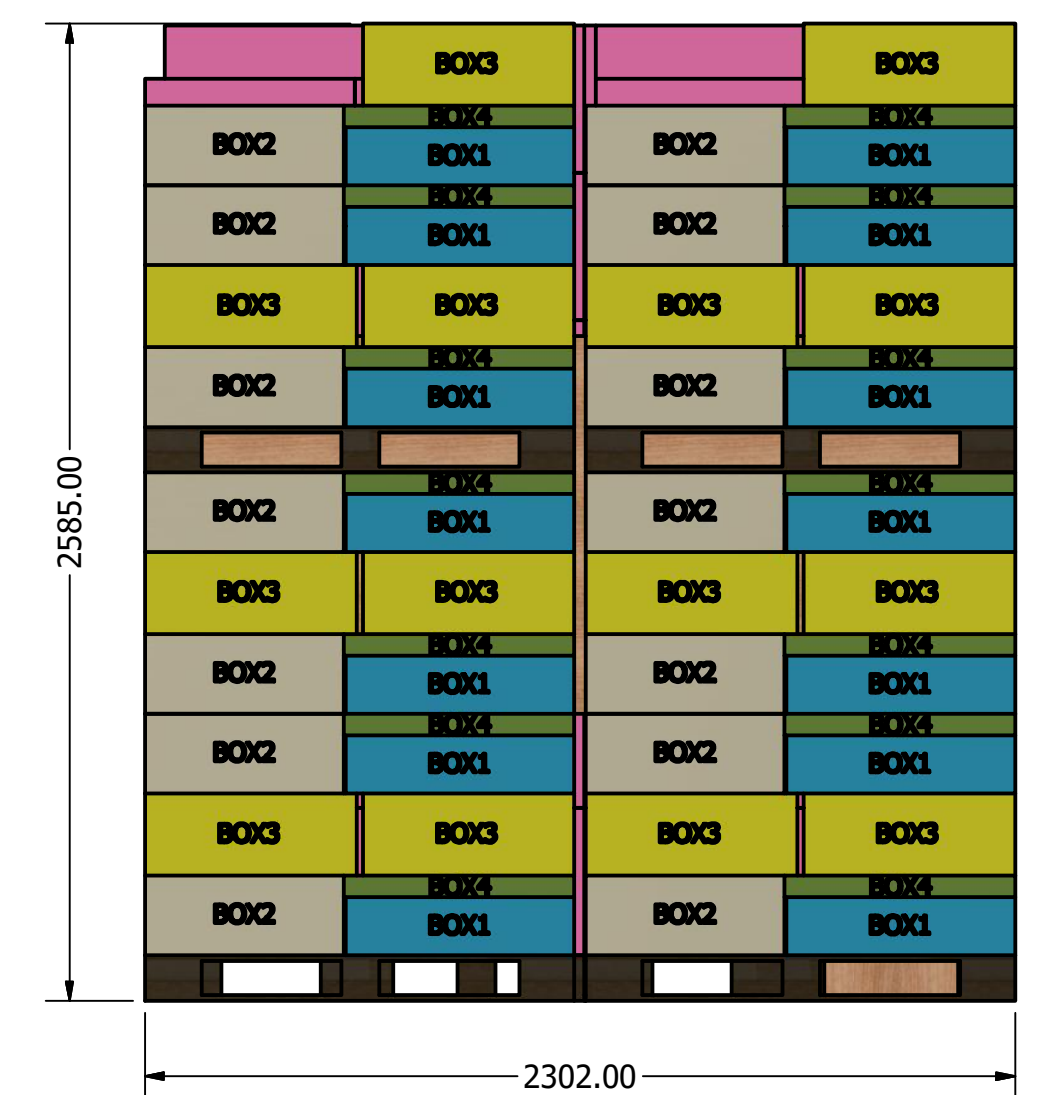

Total : Pallet A * 6, Pallet B * 6, Pallet D * 2,
Pallet E * 4, Pallet F * 2, Pallet G * 2;

DRAWN	Rudy	2019/8/19	TITLE	
CHECKED				
QA				
MFG				
APPROVED				
		SIZE	DWG NO	REV
		D	2006522	
		SCALE	1 / 20	SHEET 1 OF 1

Pallet A (Wood kit * 4)

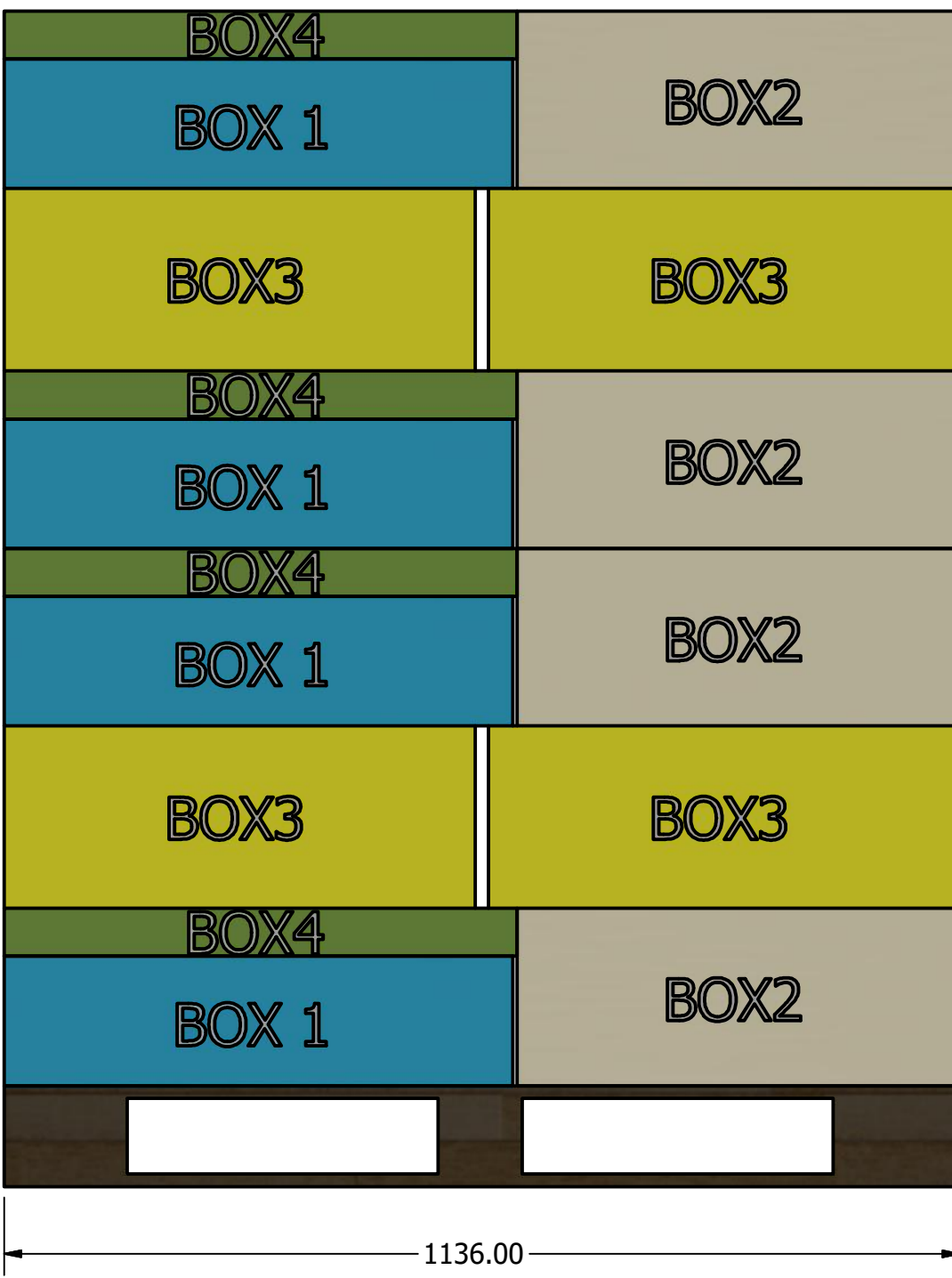
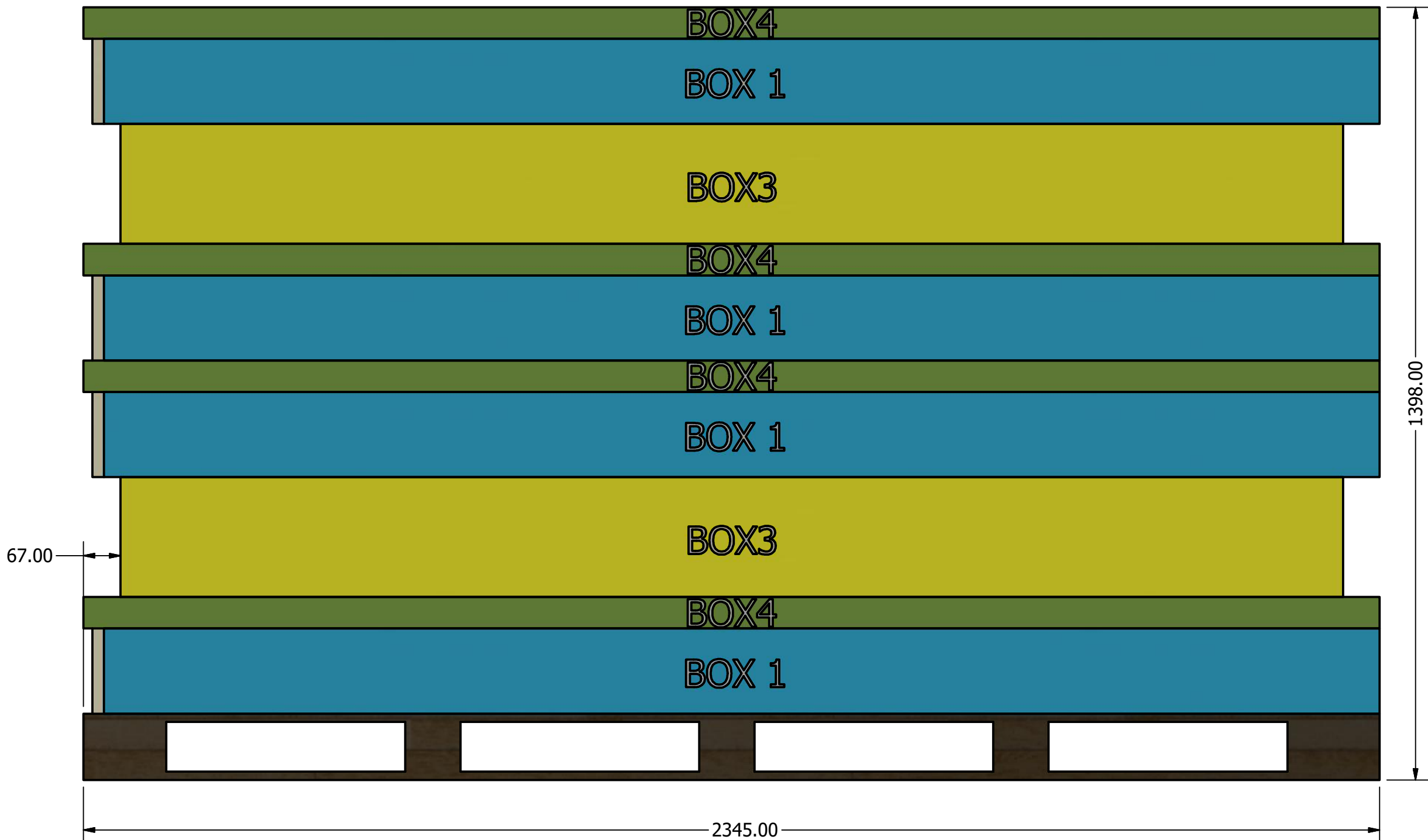
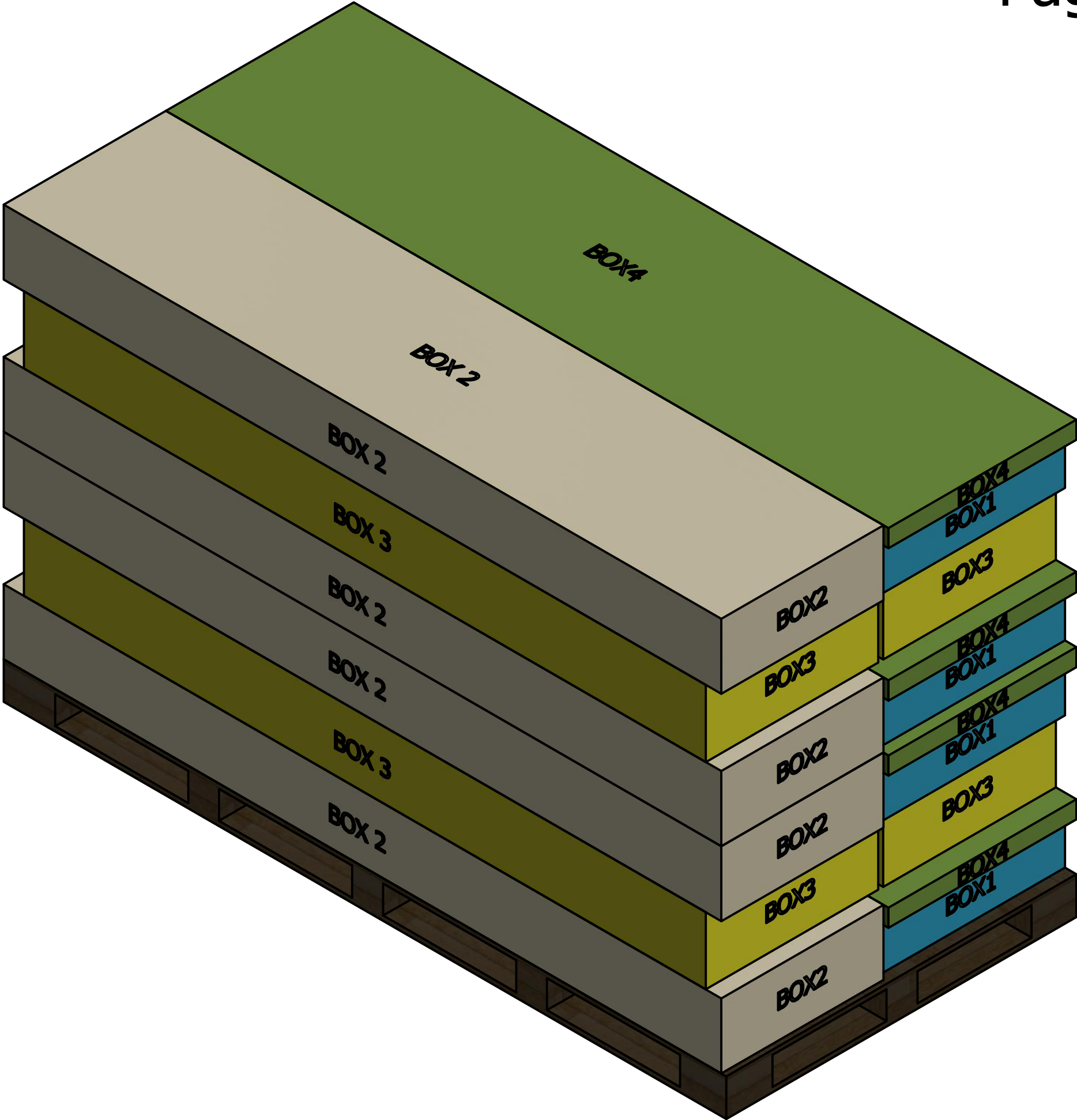

DRAWN		TITLE		
CHECKED		TITLE		
QA		TITLE		
MFG		TITLE		
APPROVED		TITLE		
		SIZE D	DWG NO	REV
		SCALE 1 : 10	SHEET 1 OF 1	

Pallet B (Wood kit * 3)

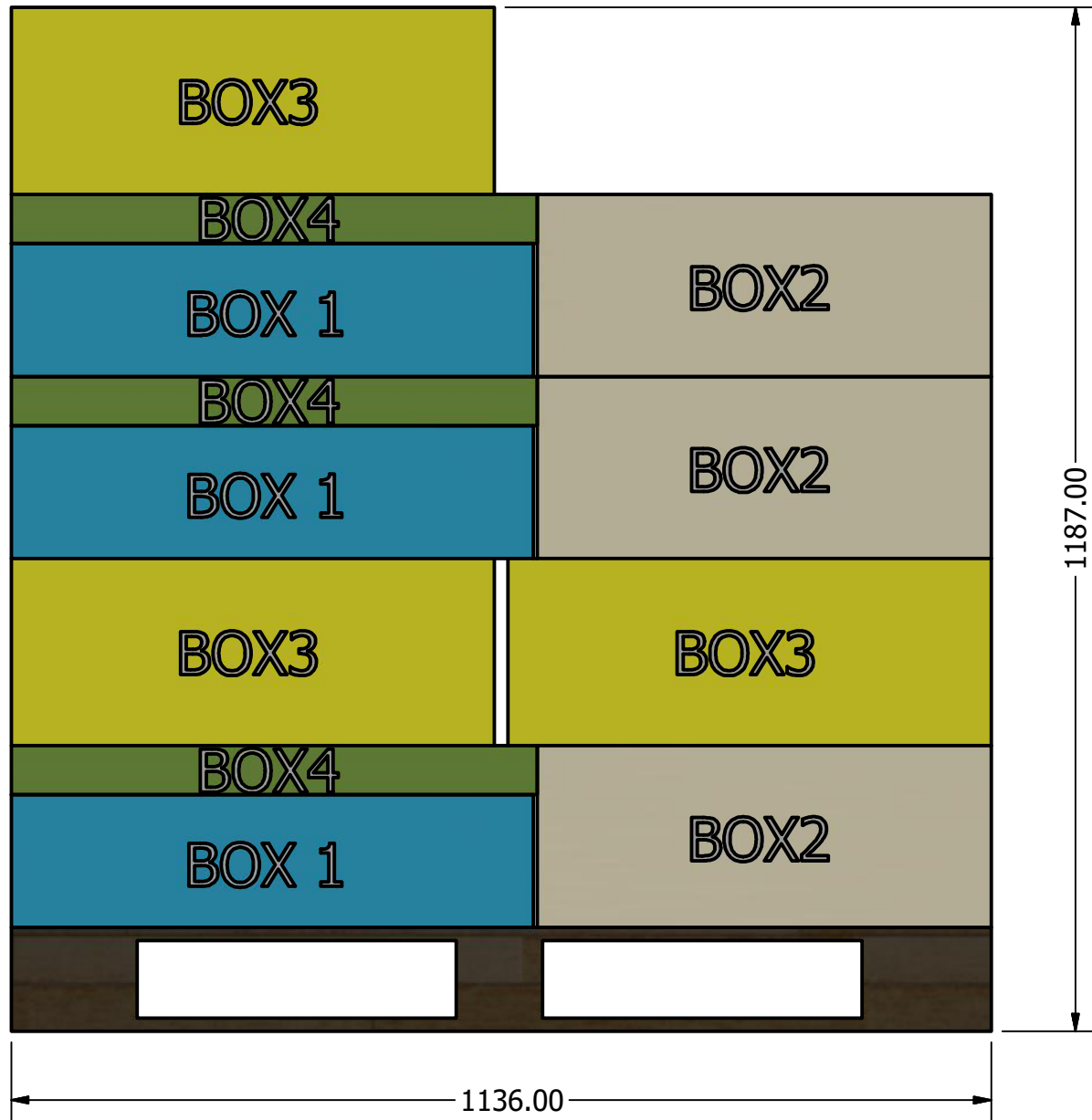
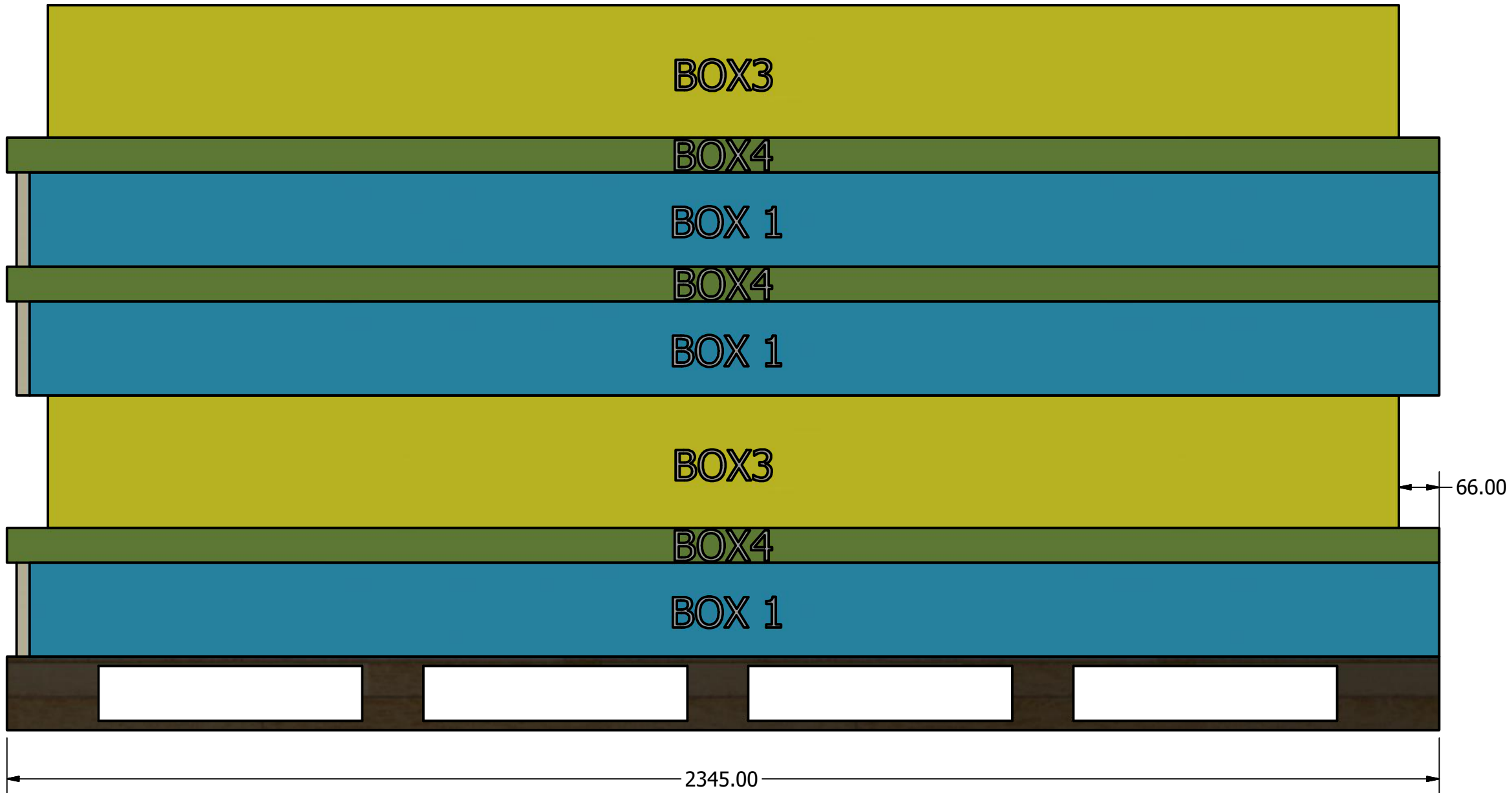
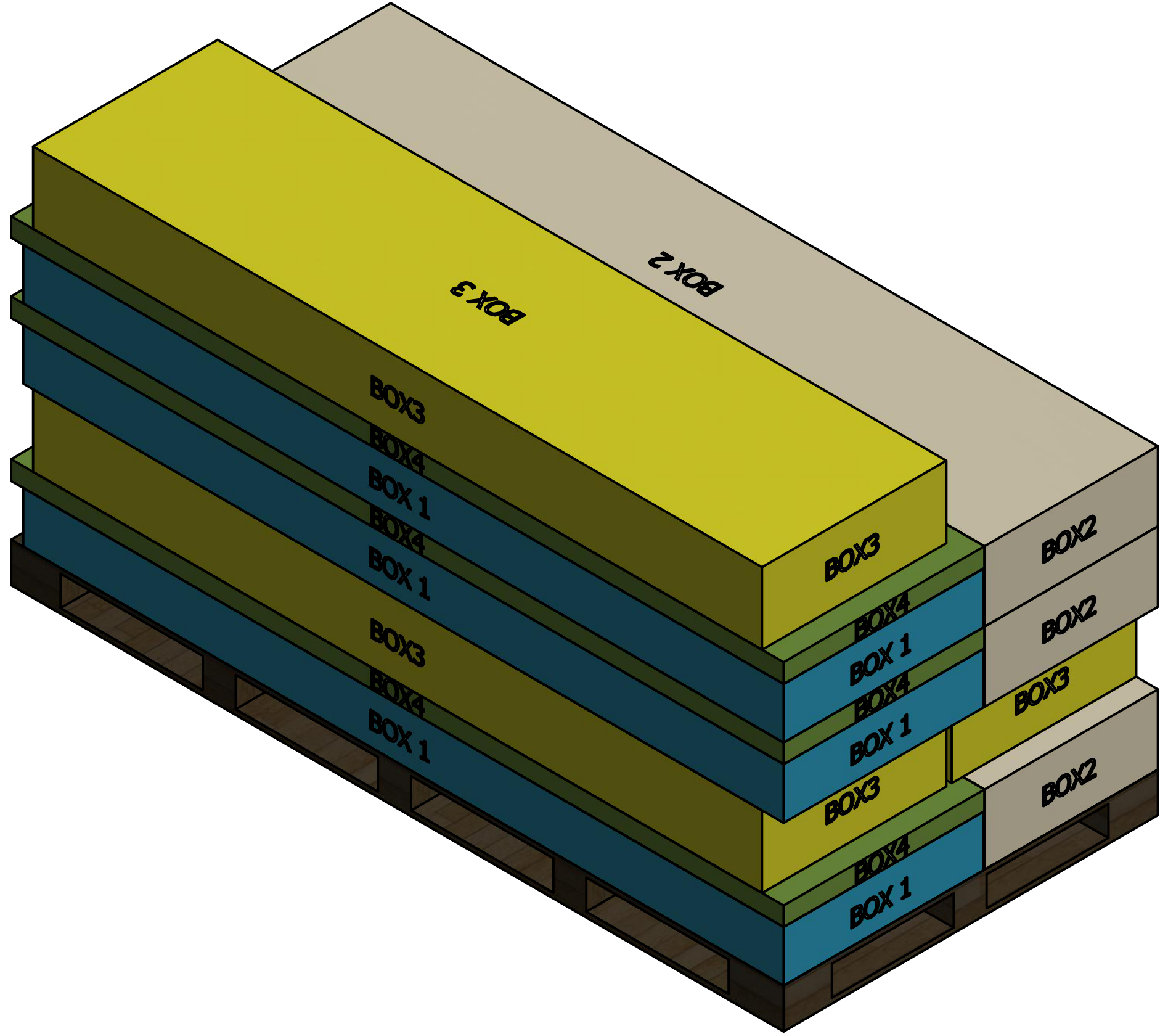
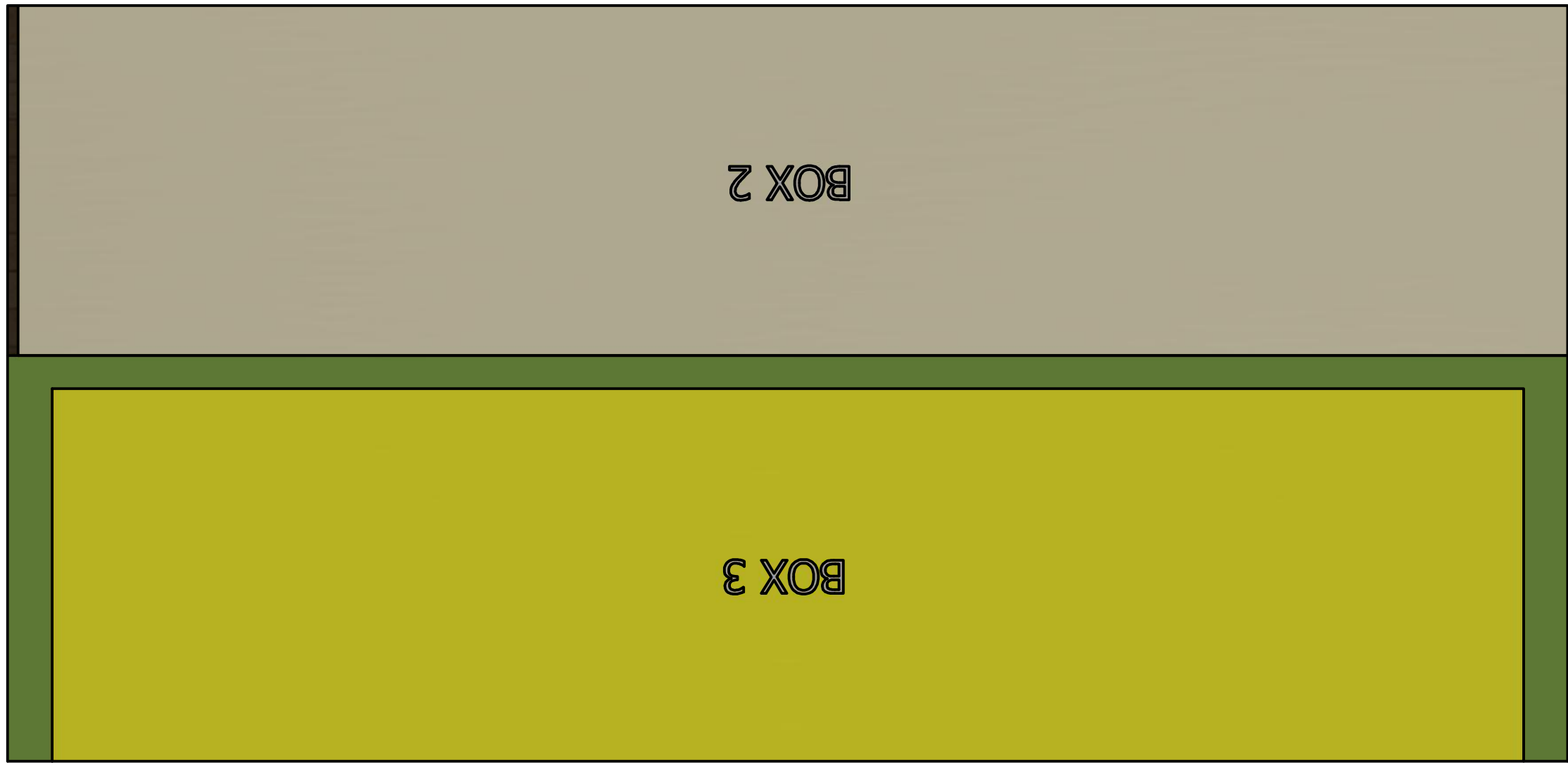

DRAWN				
CHECKED		TITLE		
QA				
MFG				
APPROVED				
		SIZE	DWG NO	REV
		D		
		SCALE	SHEET 1 OF 1	
		1: 8		

Pallet D (Wood kit * 2)

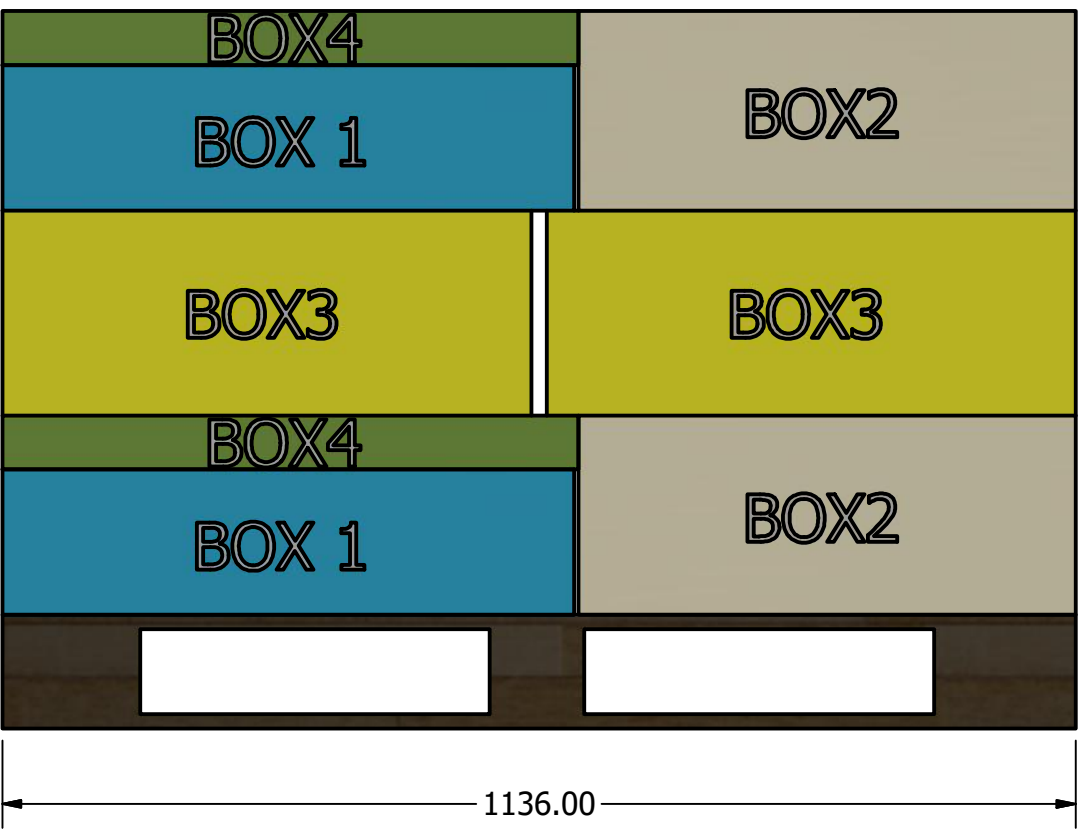
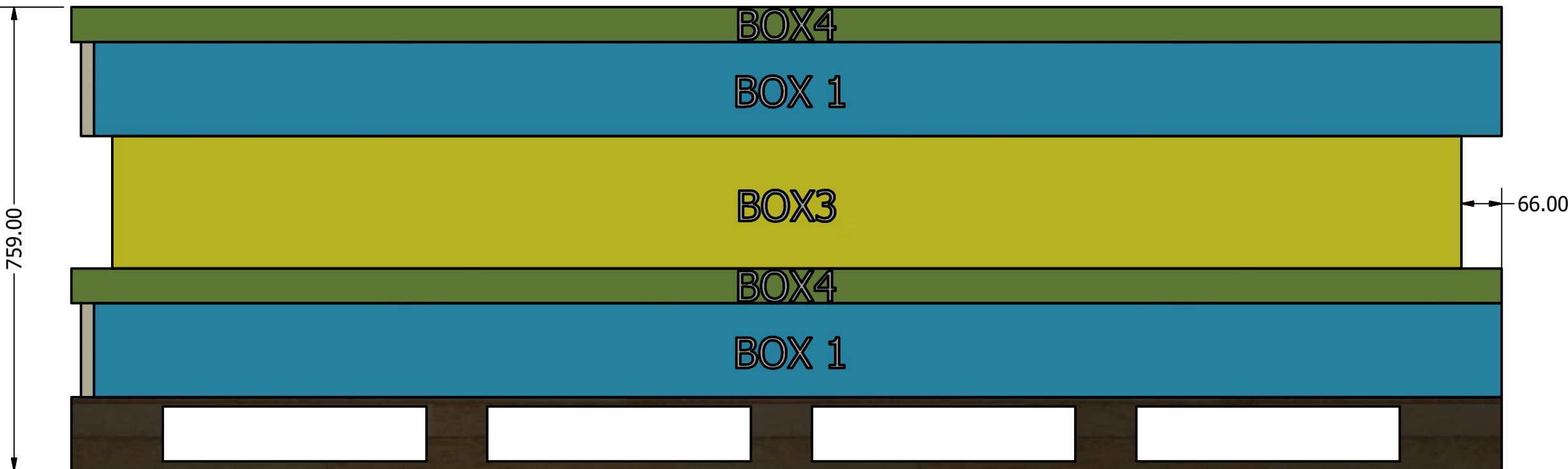
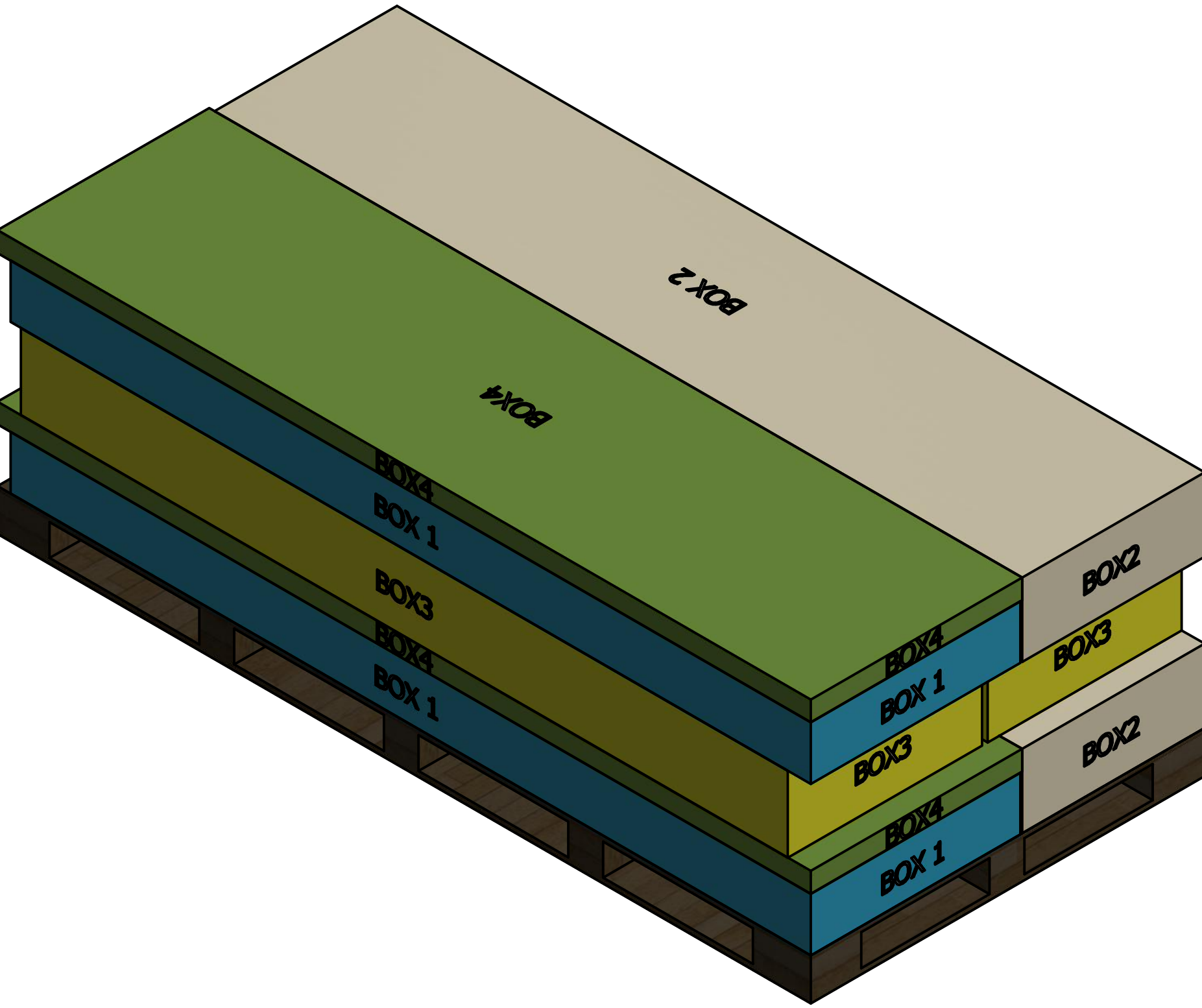
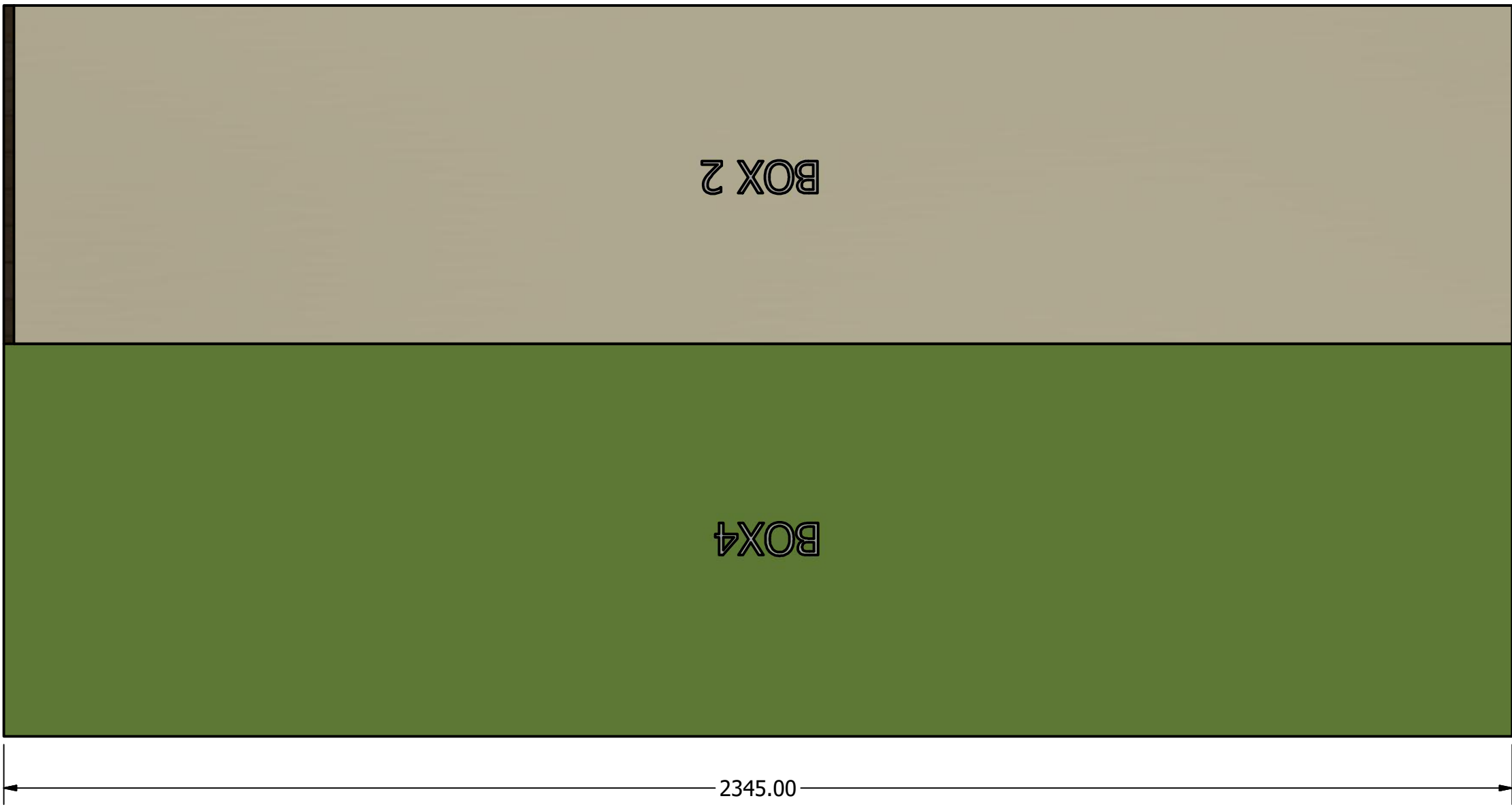

DRAWN				
CHECKED		TITLE		
QA				
MFG				
APPROVED				
		SIZE	DWG NO	REV
		D		
		SCALE	1 : 8	SHEET 1 OF 1

Pallet E (BOX5*6)

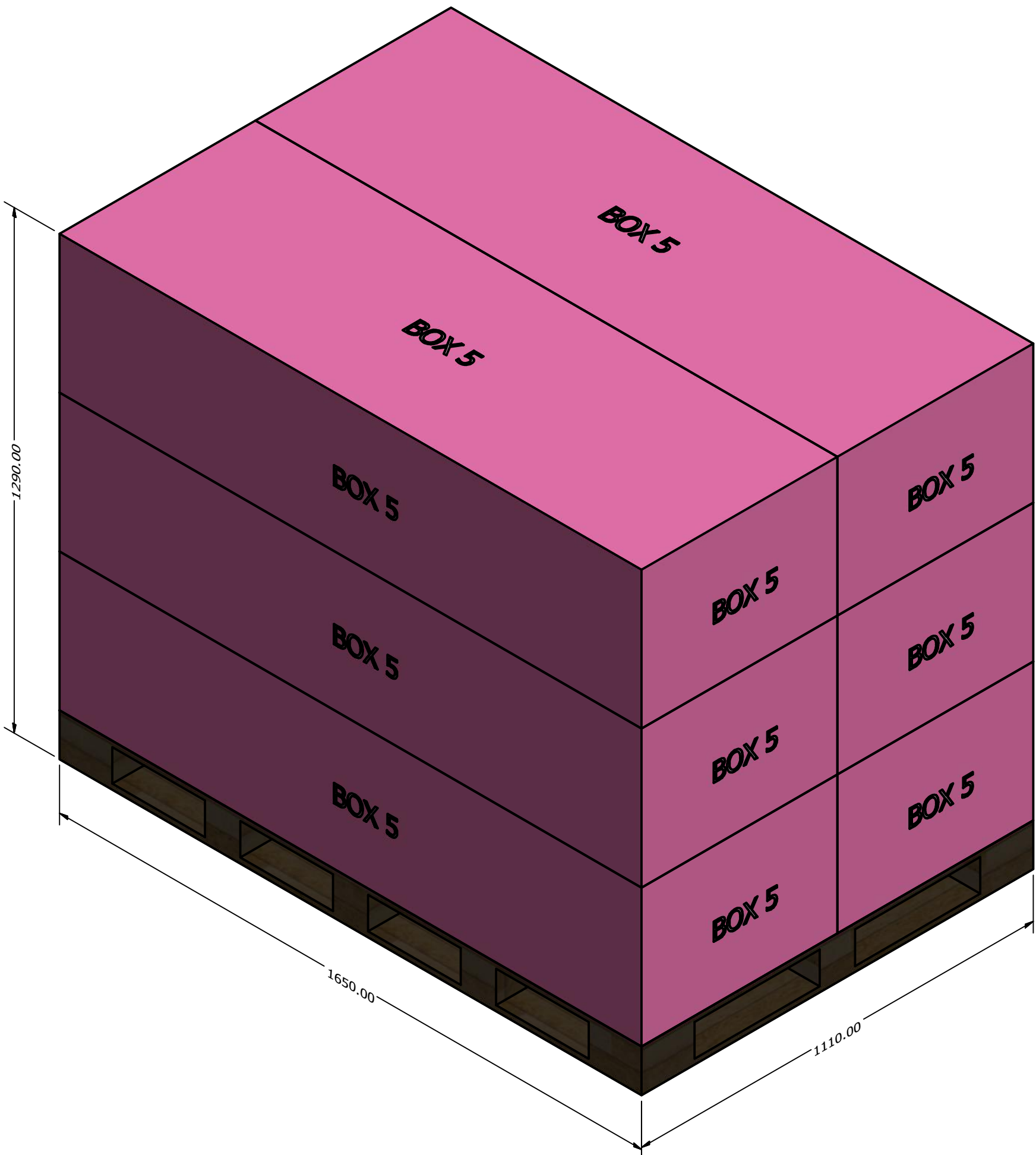

Pallet F (BOX5*8)

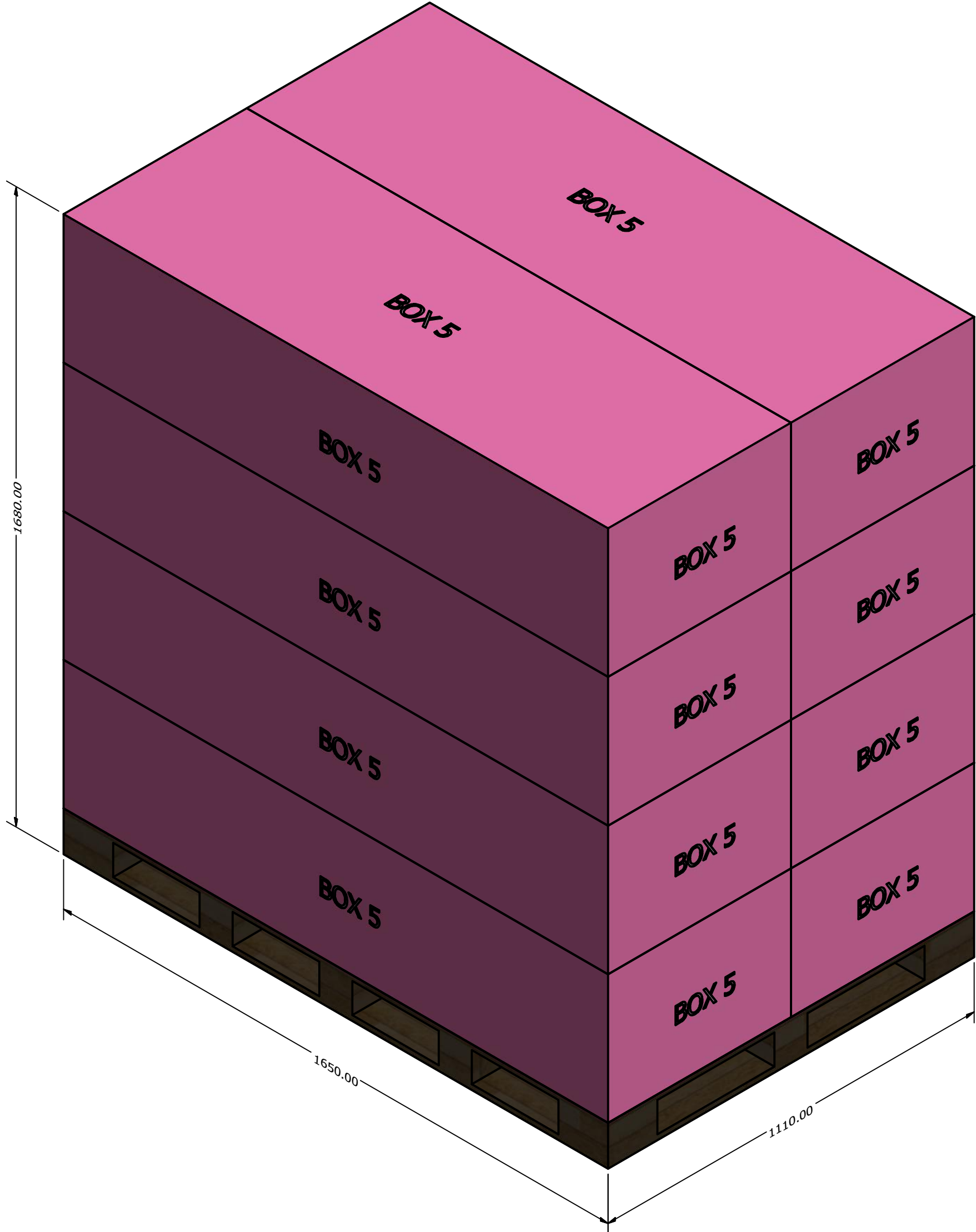

DRAWN				
CHECKED				
QA		TITLE		
MFG				
APPROVED				
		SIZE	DWG NO	REV
		D		
		SCALE	1 : 9	SHEET 1 OF 1

Pallet G (BOX5*3)

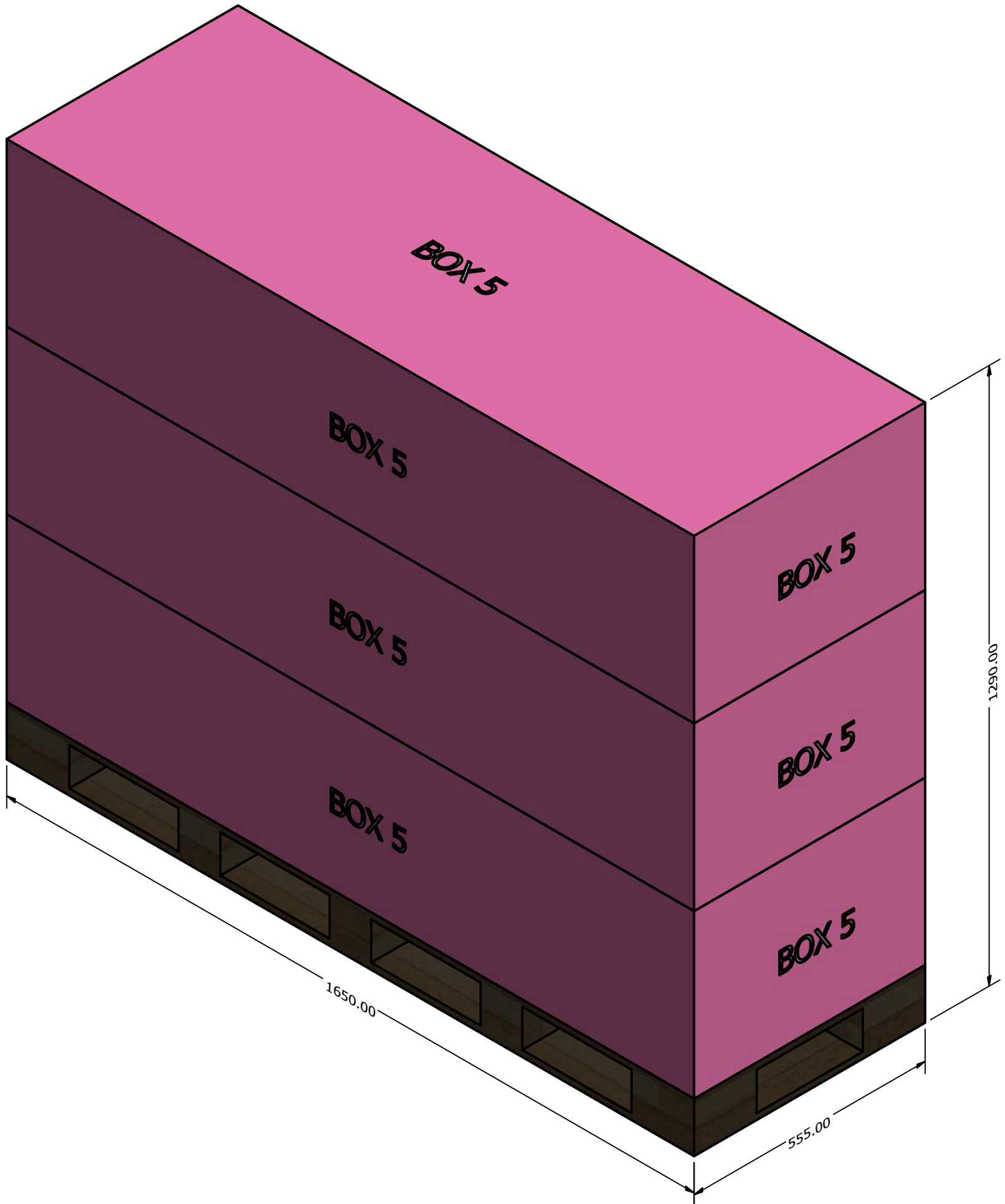

DRAWN				
CHECKED		TITLE		
QA				
MFG				
APPROVED				
		SIZE	DWG NO	REV
		D		
		SCALE	1 / 8	SHEET 1 OF 1

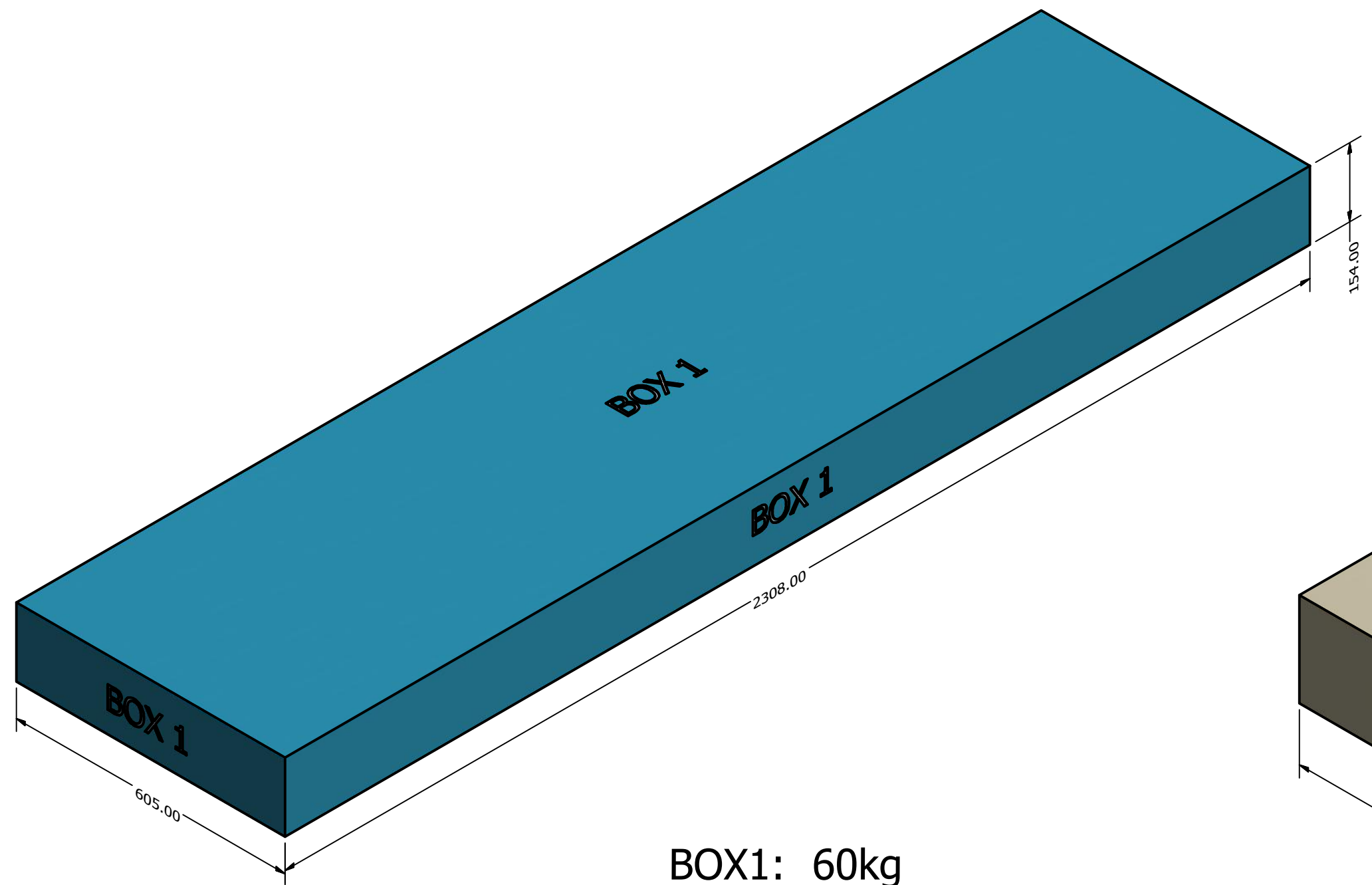

BOX1: 60kg

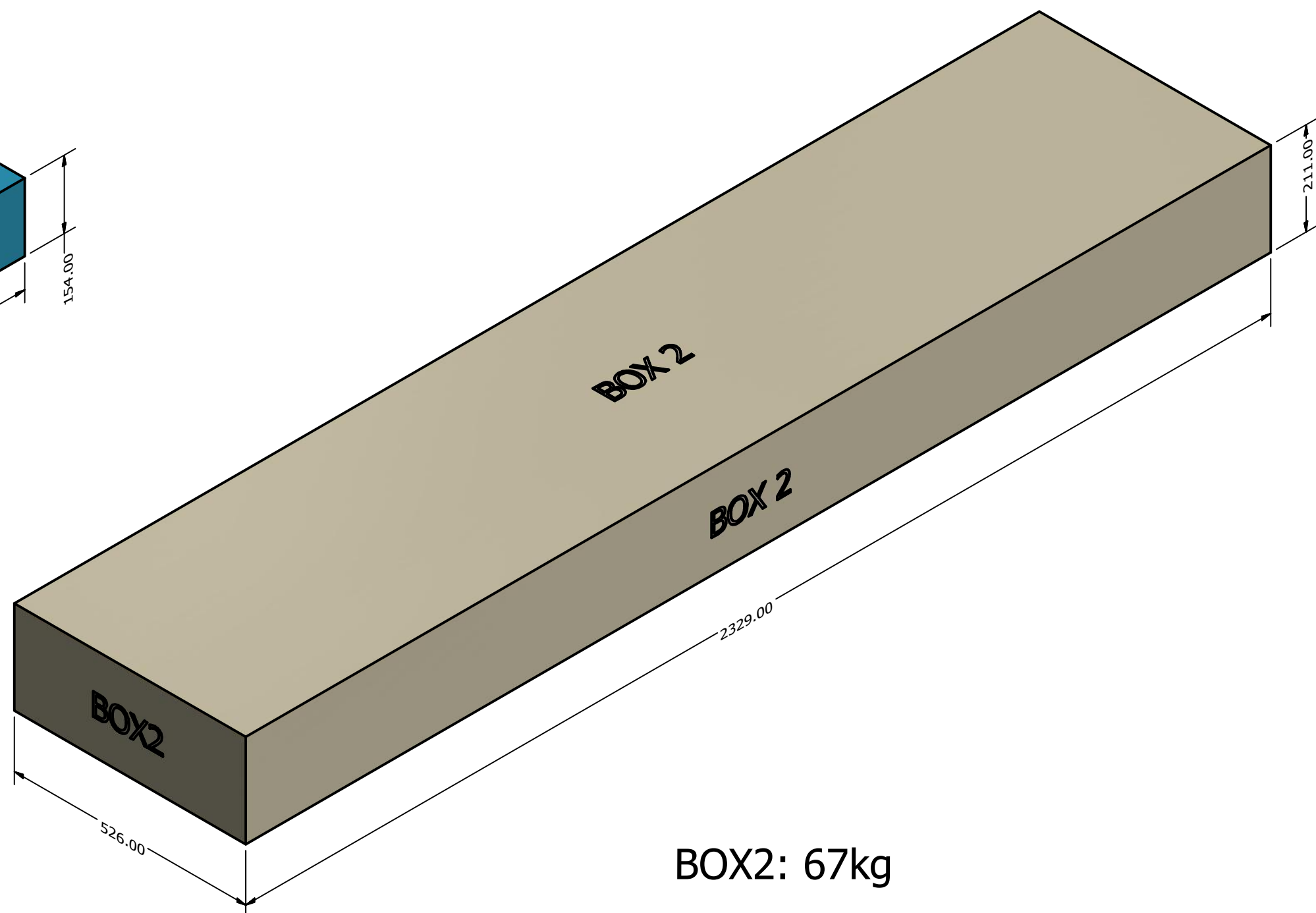

BOX2: 67kg

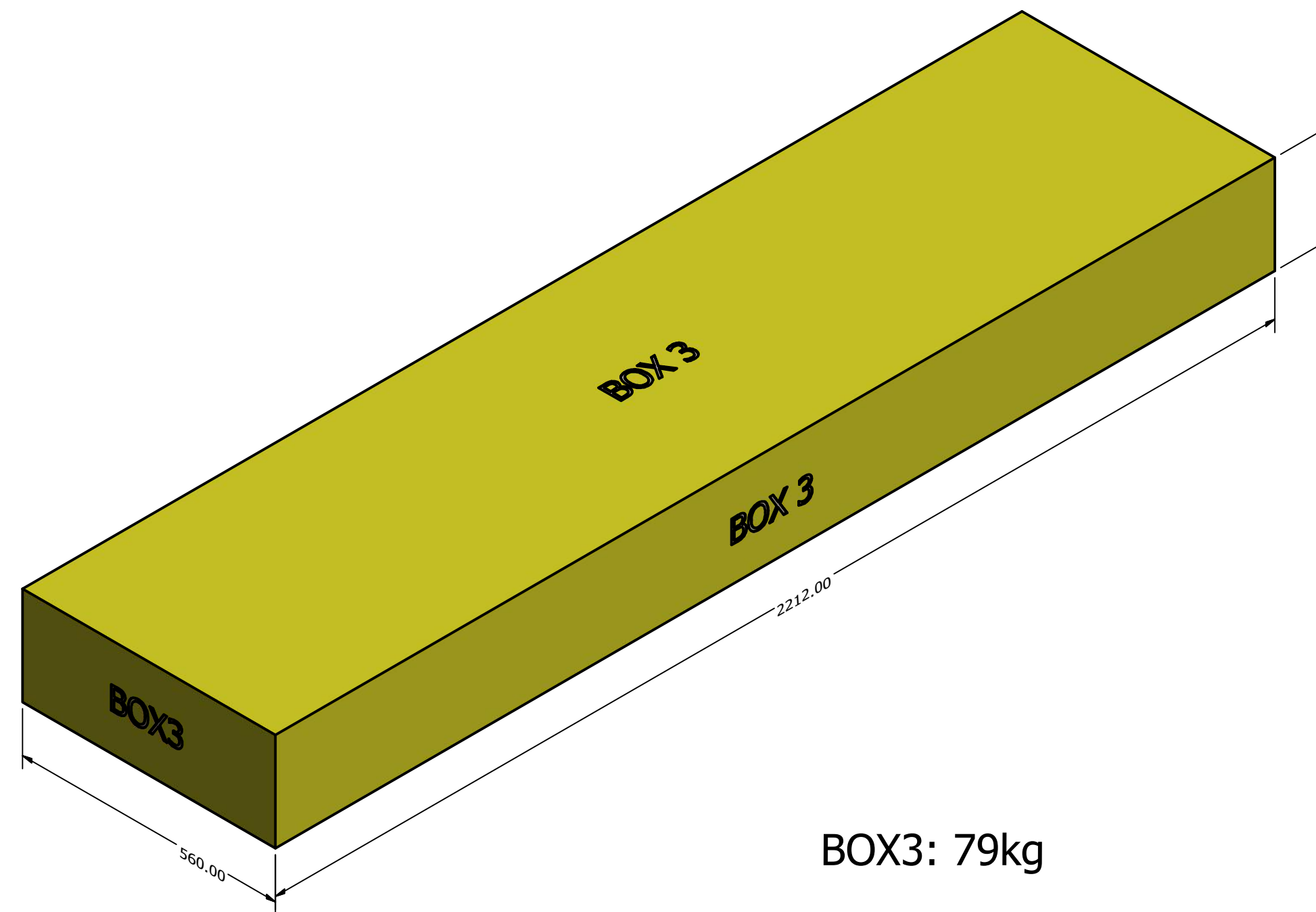

BOX3: 79kg

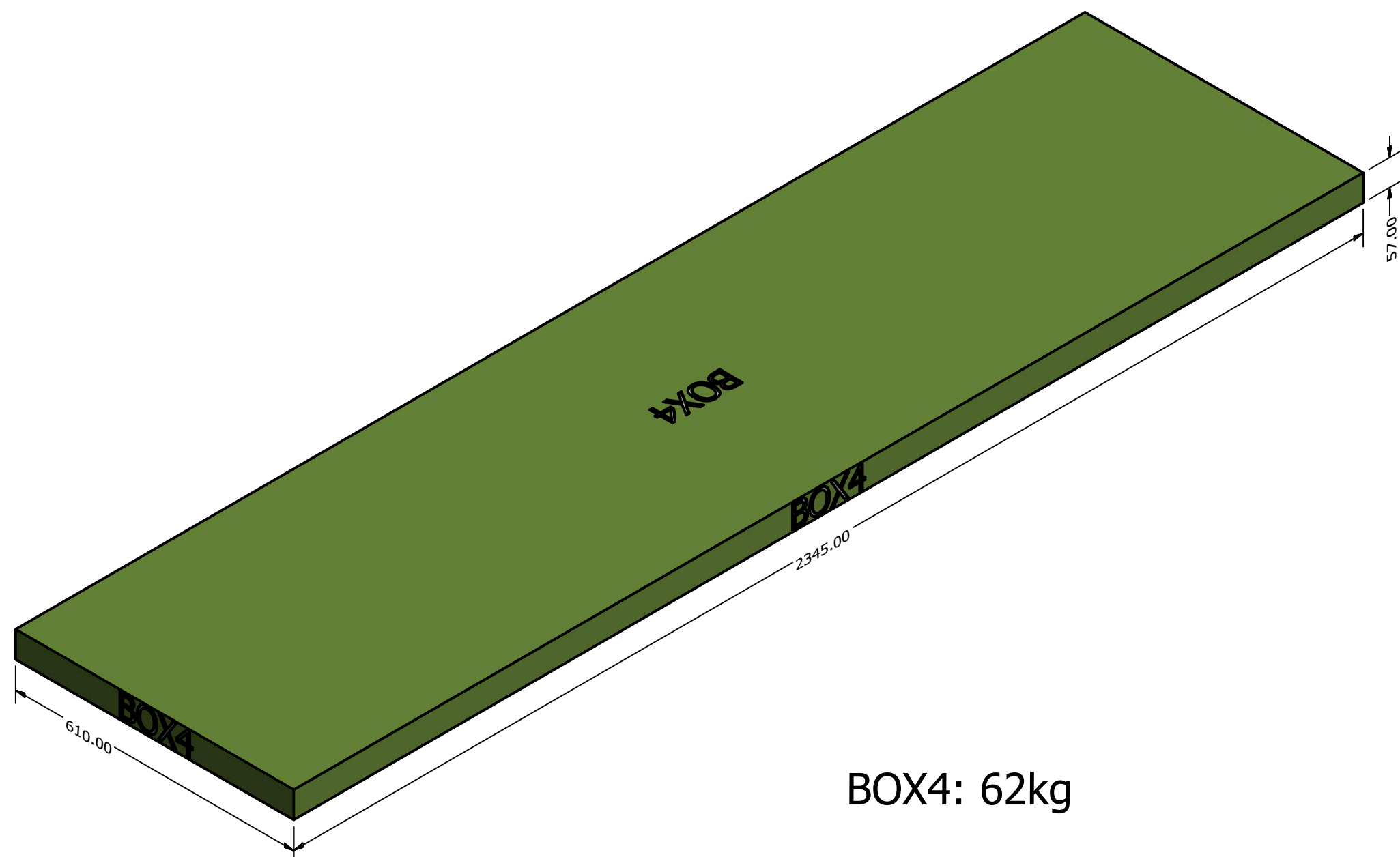

BOX4: 62kg

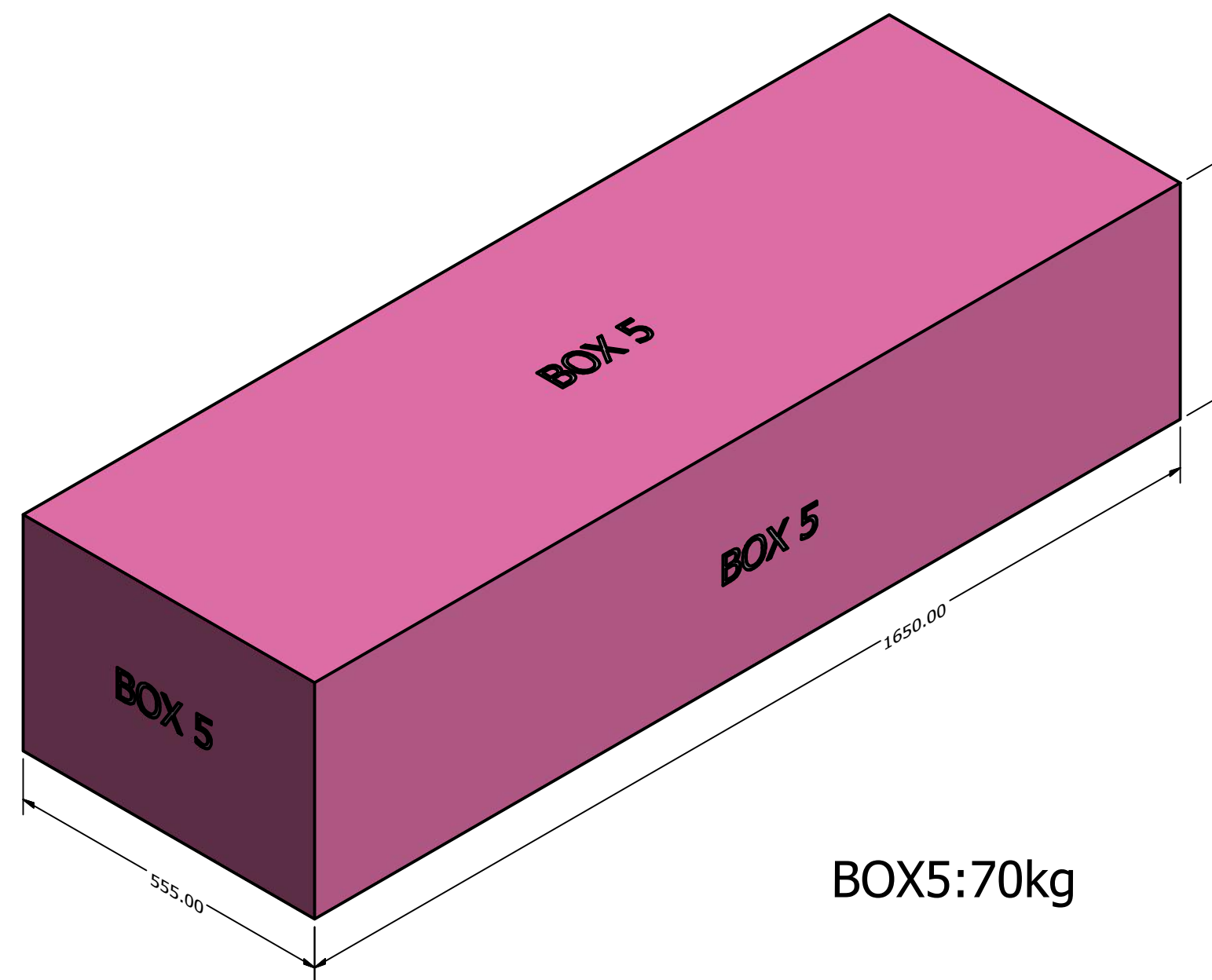

BOX5:70kg

DRAWN				
CHECKED		TITLE		
QA				
MFG				
APPROVED				
		SIZE	DWG NO	REV
		D		
		SCALE	SHEET 1 OF 1	
		1 / 8		