

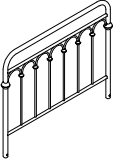

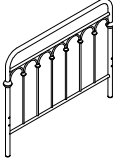

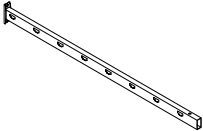

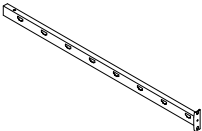

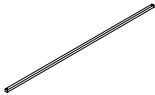
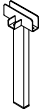
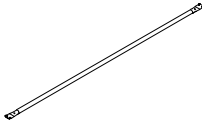

# ASSEMBLY INSTRUCTION

## METAL ARCH DESIGN TWIN PLATFORM BED

<b>A</b> Headboard Leg 	<b>B</b> Headboard 	<b>C</b> Footboard 	<b>D</b> Front Rail Section 
<b>E</b> 2PCS Rear Rail Section 	<b>F</b> 1PC Center Support Bar 	<b>G</b> 1PC Rail Support Leg 	<b>H</b> 2PCS Slat 
<b>I</b> 2PCS Slat Connector 	<b>J</b> 1PC Bolt 1/4" x 16mm 	<b>K</b> 2PCS Bolt 5/16" x 19mm 	<b>L</b> 16PCS Bolt 5/16" x 48mm 
<b>M</b> 32PCS Bolt 1/4" x 35mm 	<b>N</b> 4PCS Ratchet Tool 4mm 	<b>O</b> 8PCS 	<b>P</b> 4PCS 
<b>Q</b> 2PCS 	<b>R</b> 1PC 		

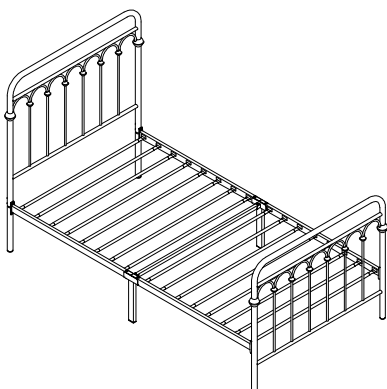

This page lists all the contents included in the box. Please take the time to identify the hardware as well as the individual components to this product. As you unpack and prepare for assembly, place the contents on a carpeted or padded area to protect them from damage.

# How to Use the Ratchet Tool (N)

1. Before assembling the furniture, please adjust the lock as needed.

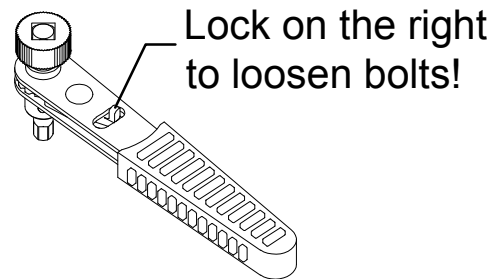
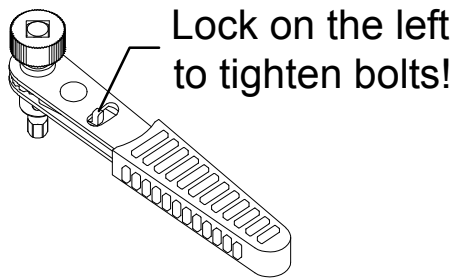

2. Tighten or loosen bolts.

- **Tighten bolts:** Locate the turncap and rotate it clockwise to screw the bolt quickly until it cannot be rotated any more. Then start rotating the handle clockwise to finalize tightening the bolt.

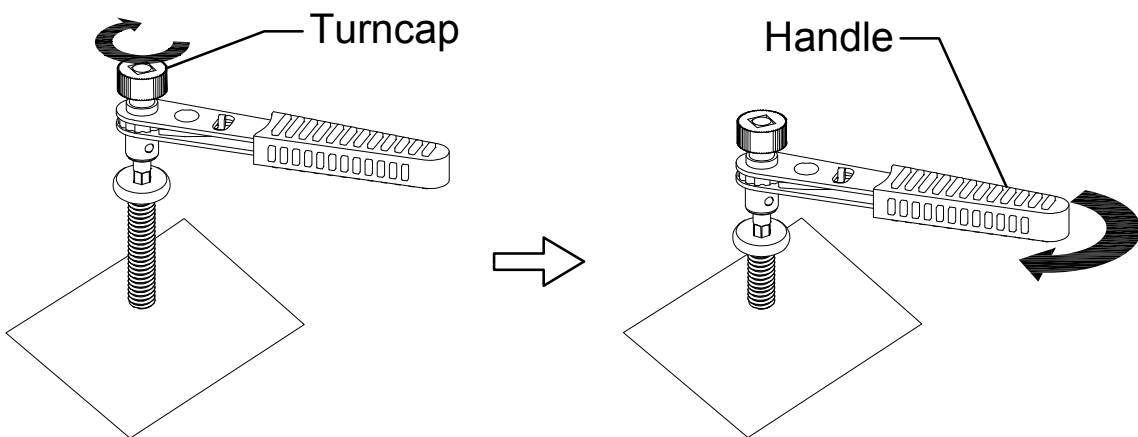

- **Loosen bolts:** Rotate the handle counterclockwise to loosen the bolt. Then continue rotating the turncap in the same direction to remove the bolt completely.

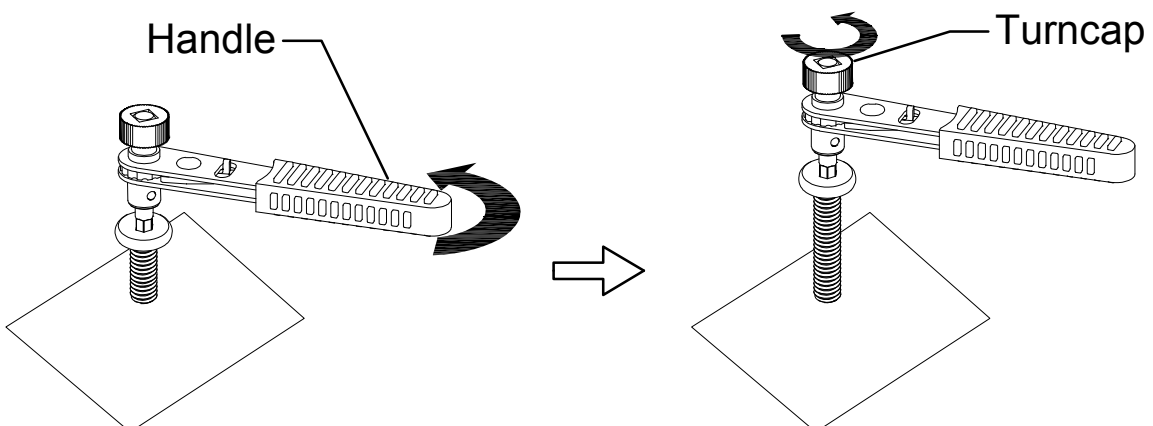

1

Attach Headboard Leg (A) to Headboard (B) using Bolt (J) with Ratchet Tool (N).

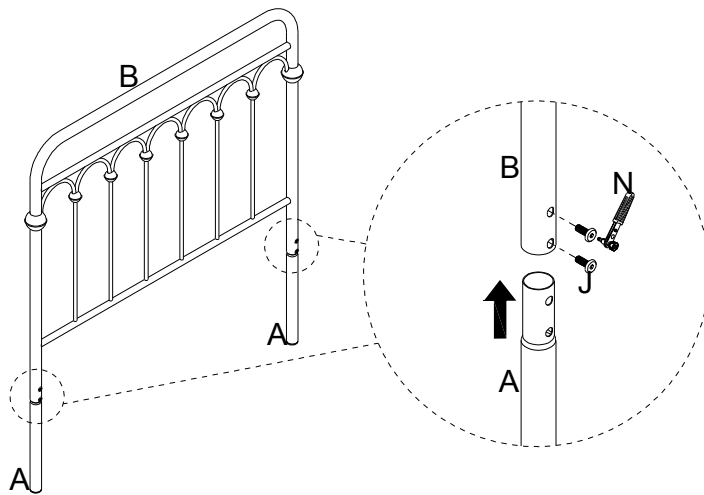

2

Attach Rail Support Leg (G) to Front & Rear Rail Section (D & E) using Bolt (L) with Ratchet Tool (N).

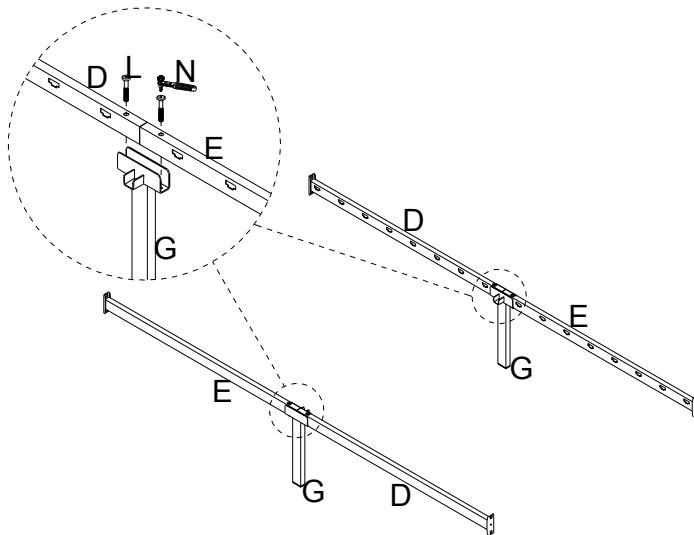

3

Attach Front & Rear Rail Section (D & E) to Headboard Leg (A), Headboard (B) and Footboard (C) using Bolt (K) with Ratchet Tool (N).

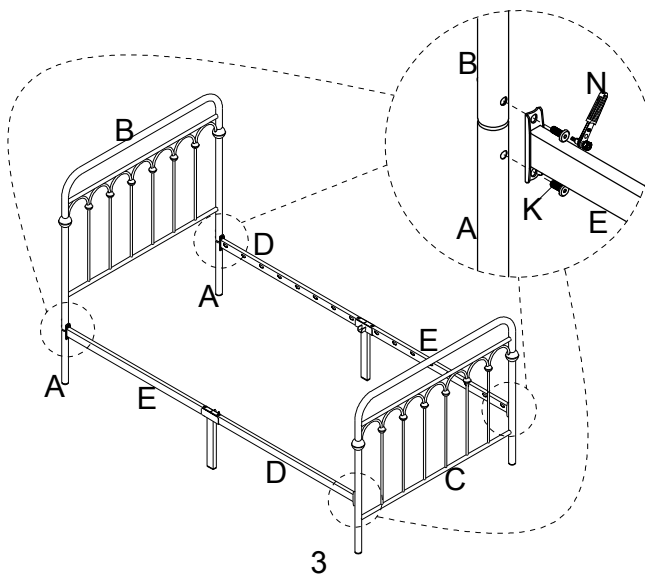

**4**

Attach Center Support Bar (F) to Rail Support Leg (G) using Bolt (M) with Ratchet Tool (N).

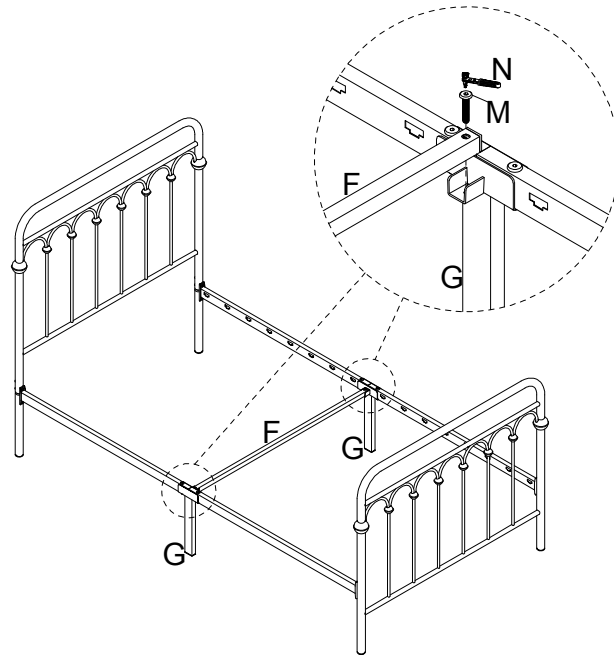
**5**

Insert Slat (H) into Front & Rear Rail Section (D & E) as shown. Then lock Slat Connector (I) to fix Slat (H).

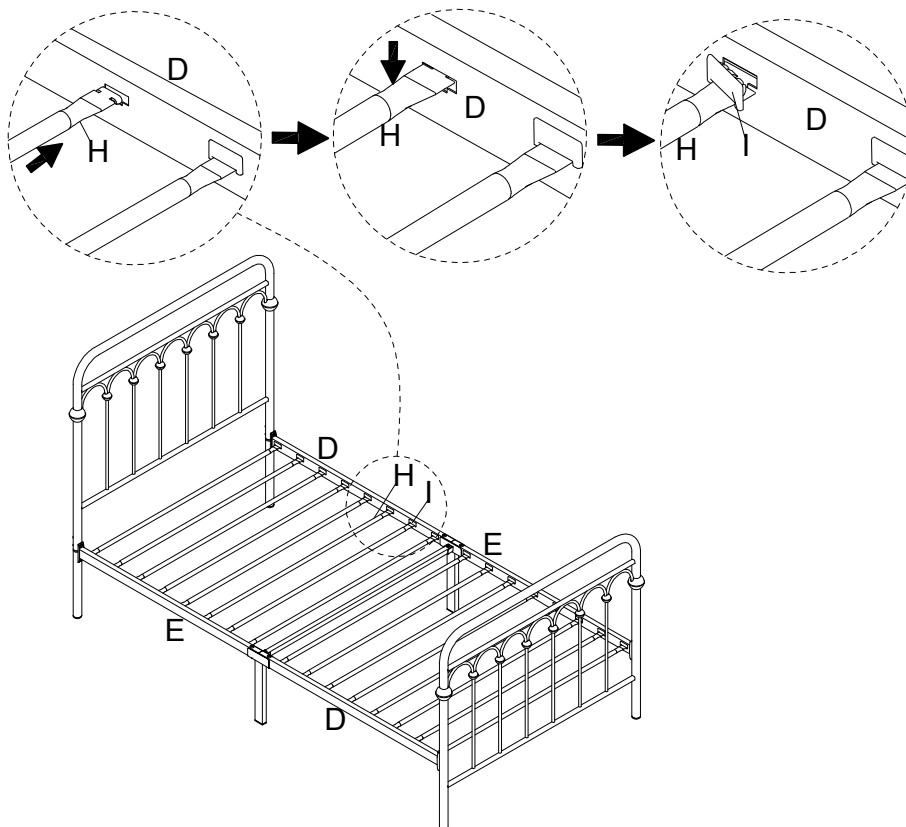

### Cleaning & Care

Treat surfaces with care. Surfaces are resistant to scratches but are not scratch resistant. Clean surfaces with a dry or damp soft cloth. Do not use abrasive cleaners. Hardware may loosen over time. Periodically check that all connections are tight.