

brother

M
TAPE

P-touch

ELECTRONIC LABELING SYSTEM

PT-M95

User's Guide

English /Español

M
TAPE

P-touch

ELECTRONIC LABELING SYSTEM

PT-M95

User's Guide

English /Español

Printed in China
LAJ616001



Safety Precautions

⚠ Warning

Follow these guidelines to avoid the risk of fire, burn, injury, electric shock, damage, overheating, abnormal odors, or smoking.

- Do not use the label maker in places of high humidity, such as bathrooms.
- Do not get the label maker wet, such as by handling it with wet hands or spilling beverages on it.
- Do not disassemble or modify the label maker/batteries.
- Do not use metallic objects, such as tweezers or a metallic pen, when changing the batteries.
- Do not throw the batteries into fire or expose to heat.
- Remove batteries immediately and stop using the label maker if you notice abnormal odor, heat, discoloration, deformation, or anything unusual while using or storing it.

⚠ Caution

Follow these guidelines to avoid personal injury, liquid leakage, burns, or heat.

- Do not touch the edge of the cutter near the print head.
- Remove the batteries if you do not intend to use label maker for an extended period of time.
- Do not use old and new batteries together, mix alkaline batteries with other battery types, or set the positive and negative end in the wrong position.
- Do not drop or hit the label maker.
- Do not press on the LCD.
- Do not put your fingers inside the label maker while trying to close the cassette cover.

Introduction

With your new Brother label maker, you can create a wide variety of custom, self-adhesive labels. This label maker uses Brother "M" Series tapes in 0.35" (9mm) and 0.47" (12mm) widths, available in a variety of colors. Visit www.brother.com for a complete list of tapes that work with your label maker.

Read this manual carefully before starting and keep it in a handy place for future reference.

The contents of this guide and the specifications of this product are subject to change without notice.

Federal Communications Commission (FCC) Compliance Notice (For USA Only)

This equipment has been tested and found to comply with the limits for a Class B digital device, pursuant to Part 15 of the FCC Rules. These limits are designed to provide reasonable protection against harmful interference in a residential installation. This equipment generates, uses, and can radiate radio frequency energy and, if not installed and used in accordance with the instructions, may cause harmful interference to radio communications. However, there is no guarantee that interference will not occur in a particular installation. If this equipment does cause harmful interference to radio or television reception, which can be determined by turning the equipment off and on, the user is encouraged to try to correct the interference by one or more of the following measures:

- Reorient or relocate the receiving antenna.
- Increase the separation between the equipment and receiver.
- Consult the dealer or an experienced radio/TV technician for help.

Important

- Changes or modifications not expressly approved by Brother Industries, Ltd. could void the user's authority to operate the equipment.

General Precautions

- Depending on the location, material, and environmental conditions, the label may unpeel or not be able to be removed, the color of the label may change or be transferred to other objects. Before applying the label, check the environmental condition and the material.
- Do not use the label maker in any way or for any purpose not described in this guide. Doing so may result in accidents or damage to the label maker.
- Use Genuine Brother P-touch M tapes with this label maker. Do not use tapes that do not have the **M** mark.
- Use only a soft, dry cloth to clean the label maker; never use alcohol or other organic solvents.
- Use a soft, dry cotton swab to clean the print head; never directly touch the print head with your fingers.
- Do not put any foreign objects into the tape exit slot to prevent causing the paper jam.
- Do not place the label maker or batteries in direct sunlight or rain, near heaters or other hot appliances, in any location exposed to extremely high or low temperatures (for example, on the dashboard or in the back of your car), high humidity, or dusty locations.
- Do not apply excessive pressure to the cutter lever.
- Do not try to print if the cassette is empty as it will damage the print head.
- Do not pull the tape while printing or feeding as it will damage the tape and label maker.
- Any data stored in memory will be lost due to failure to repair the label maker or if the batteries expire.
- When power is disconnected for more than three minutes, all text, format settings, and any text files stored in the memory are cleared.
- Do not use rechargeable AAA batteries.
- A protective clear plastic sticker is placed over the display during manufacturing and shipping. This sticker should be removed prior to use.

Power Supply and Tape Cassette

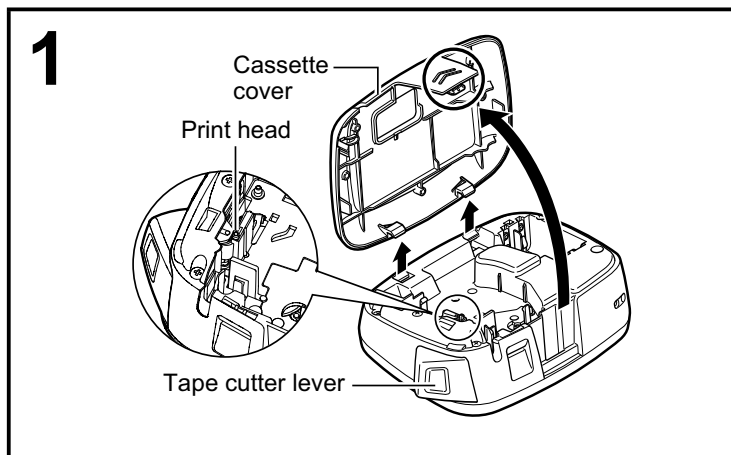

1 Remove the cassette cover by pressing the above indicated area.

If you already installed a tape cassette, remove it by pulling it straight up. If you already installed batteries, remove them as well.

- Make sure the power is turned off when replacing batteries or tape cassettes.

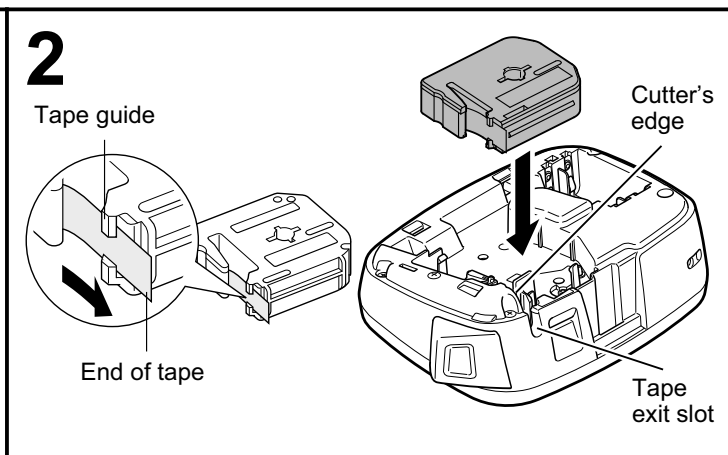

2 Insert a tape cassette, making sure it snaps into place.

- Make sure the end of the tape feeds under the tape guides.
- Use Genuine Brother P-touch M tapes with this label maker.

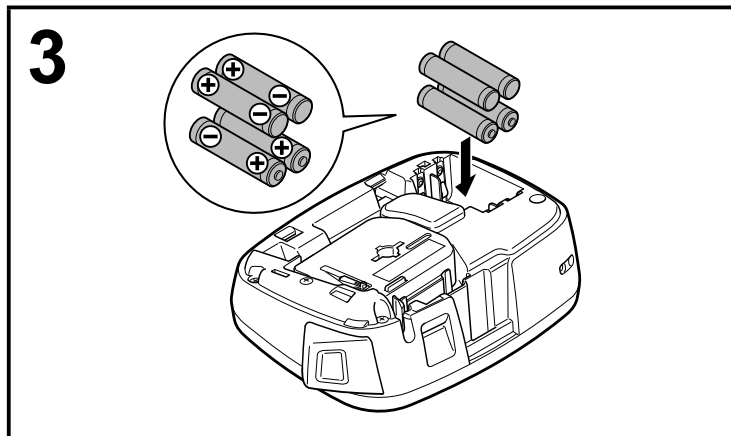

3 Insert four new AAA alkaline batteries (LR03), making sure their poles point in the correct directions.

- Always replace all four batteries at the same time with brand new ones.
- Remove the batteries if you do not use the label maker for an extended period of time.

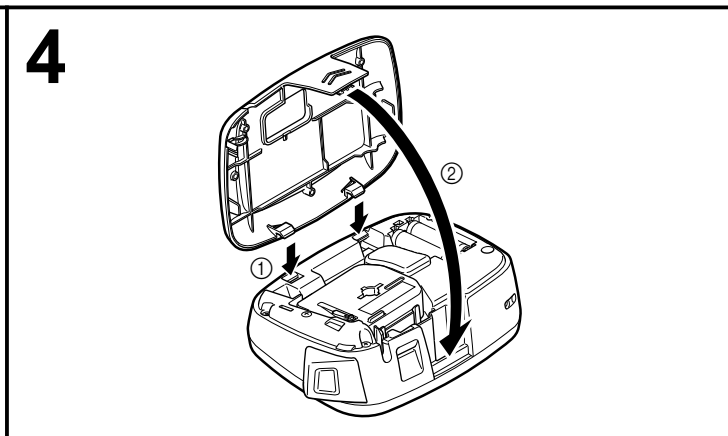

4 Insert the two hooks at the bottom of the cassette cover into the slots on the label maker (①), and then close the cover securely until it snaps into place (②).

After you have installed the tape, feed the tape (see "Feeding") once, and then push in the tape cutter lever to cut the tape.

Keyboard

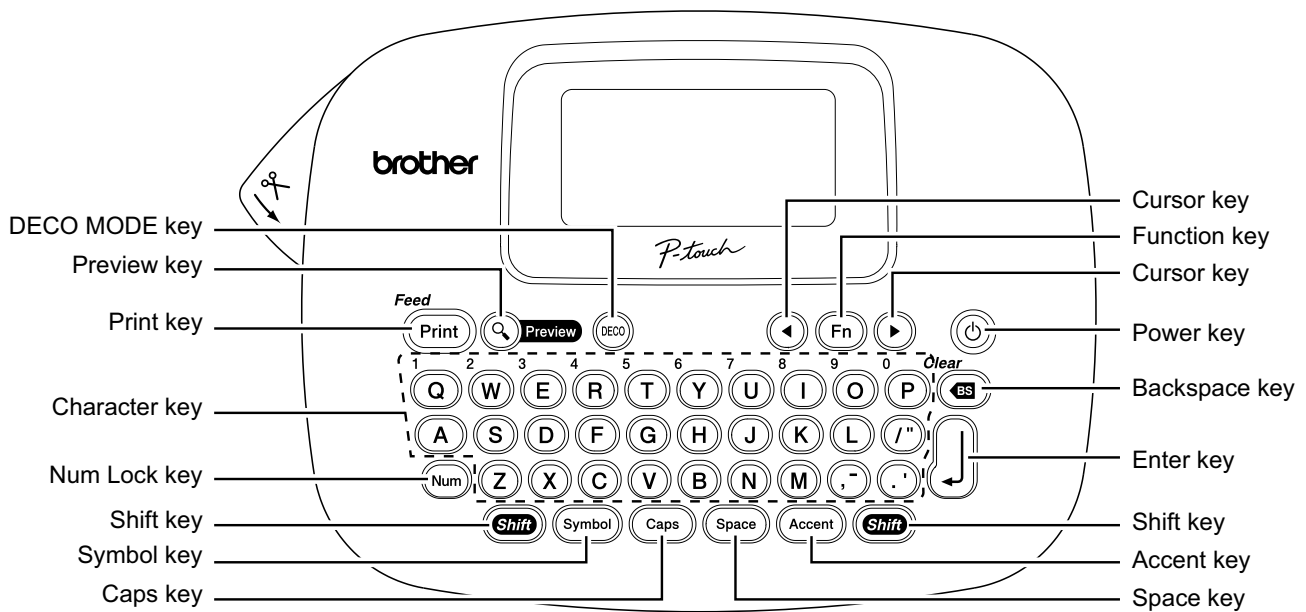

LCD

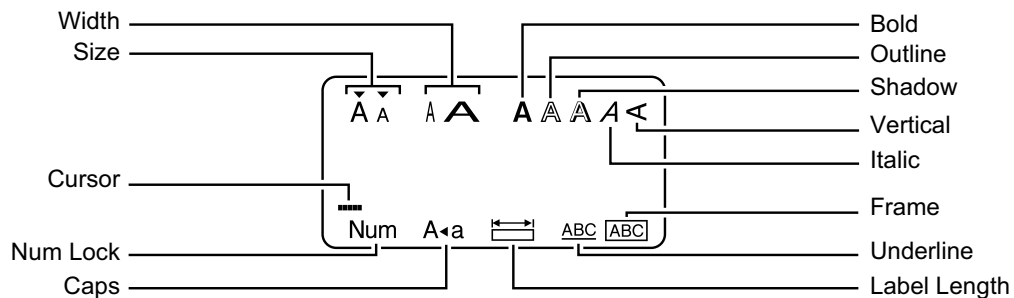

NOTE

The LCD displays one row of 12 characters; however, you can enter up to 80 characters in length.

Initial Settings

1 Turn on your label maker.

Supply power using four AAA batteries, and then press

to turn the power on.

2 Set the language.

The default setting is [English].

→ [Language]
 → [English/Español/Français/
 Italiano/Nederlands/Norsk/Português/
 Svenska/Türkçe/Dansk/Deutsch]

• You can also display [Language] by pressing and at the same time.

3 Set the unit of measurement.

The default setting is [inch].

→ [Unit]
 → [inch/mm]

• You can also display [Unit] by pressing and .

NOTE

- The label maker automatically turns off if no keys are pressed within five minutes.
- To cancel operations, press .
- To reset the label maker back to factory settings, see "Resetting the label maker".

Entering Text and Accented Characters

► Switching Upper Case/Lower Case



Caps

Upper case ((Caps) ON)

Lower case ((Caps) OFF)

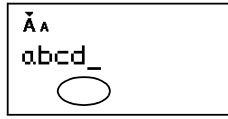
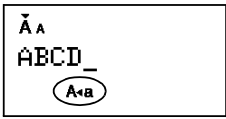

► Entering Numbers



Num

→ ¹Q ²W ³E

Num Lock ON

Num Lock OFF

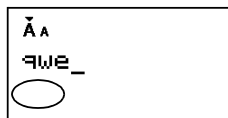
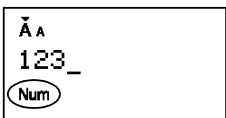

► Making a Two Line Label

1. Enter the text for the first line and press .
2. Enter the text for the second line and press .

- Do not press after the second line; otherwise the "Line Limit!" error message will appear on the display.

Display

Label image

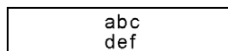
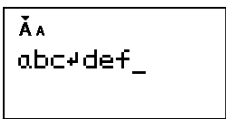

► Entering Accented Characters



(A) - (Z) → Accent → Accent / ◀ ▶ →

	Accented Characters
A	Á À Ã Ä Å Æ Å Ç Å Ä Å
C	Ç Ć Ć
D	Đ Đ
E	É Ê Ë Ë Ę Ę Ę Ę
G	Ğ Ğ
I	Í Î Ï Ĭ Ĭ Ĭ Ĭ Ĭ Ĭ
K	Ķ Ķ
L	Ł Ł Ł Ł
N	Ń Ń Ń Ń
O	Ó Ò Ô Ø Ö Ö Œ Ó
R	Ř Ř Ŕ
S	Š Š Š Š Š
T	Ť Ť Þ
U	Ú Û Ü Ü Ü Ü Ü Ü
Y	Ý Ÿ
Z	Ž Ž Ž

	Accented Characters
a	á à â ä å æ å ç å ä å
c	ç ć ć
d	đ đ đ
e	é ê ë ě ě ě ě
g	ğ ğ
i	í î ï ĭ ĭ ĭ ĭ ĭ ĭ
k	ķ ķ
l	ł ł ł ł
n	ń ń ń ń
o	ó ò ô ø ö ö œ ó
r	ř ř ŕ
s	š š š š š
t	ť ť þ
u	ú û ü ü ü ü ü ü
y	ý ŷ
z	ž ž ž

- To cancel operations, press .
- The order of accented characters differs by the selected LCD language.

► To Clear (Fn + Y)

By pressing , the letters are deleted one by one.



NOTE

To delete all text and settings :



+ → [Txt&Format]

To delete text only :



+ → [Text Only]

Adding Symbols

▶ Entering Symbols

Example: Entering 

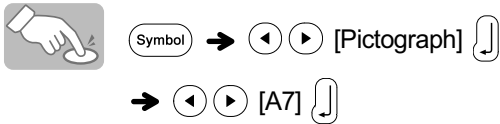

Display



Label image



- Pictographs are displayed on the LCD with the corresponding alphabet and number of the Pictograph table.



The following symbols are available:

Basic

01	.	,	:	;	"	'	•
02	@	-	&	~	_	\	/
03	#	%	?	!	¿	¡	*
04	+	-	×	÷	±	=	≧
05	≦	≠	∴	()	[]
06	<	>	§	«	»	【	】
07	→	←	↑	↓	↔	↔	↕
08	®	©	™	\$	¢	€	£
09	¥	°	♪	♫	α	β	γ
10	δ	μ	Ω	φ	Σ	0	1
11	2	3	4	5	6	7	8
12	9	0	1	2	3	4	5
13	6	7	8	9	I	II	III
14	IV	V	●	○	■	□	★
15	☆	♠	♣	♥	♡	♦	◇
16	♣	♣	▲	△	▼	▽	+
17	●	?	♂	♀	✓	▶	▶
18	◀	◀	⏻	○		⊖	⊕

Pictograph

	1	2	3	4	5	6	7
A	⊘	⚠	☠	🔥	♻	⊘	☎
B	📅	📞	✉	👂	👃	👄	👅
C	🌸	👛	🗑	🍺	🗑	🏥	🏪
D	🎃	👼	👶	🎅	🎄	👶	👶
E	📁	🎂	🍰	🍰	🍓	🍓	🍏
F	👶	👶	👶	👶	👶	👶	👶
G	🐶	🐱	🐰	🐵	🐶	🐷	👻
H	🌻	🌻	🌻	🌐	🌴	🌻	🌻
I	🔑	📺	📺	📺	📺	📺	📺
J	🚗	🚲	🚆	👉	📺	📺	📺
K	👂	📖	👁	📺	🔑	📺	📺
L	❤	🎵	👉	🌈	📺	👑	🐾

- To display the next group, press .
- To cancel operations, press .
- Symbols surrounded by a box in the Basic table are available in DECO MODE.
- You can select the rows of symbols (A to L) in the Pictograph table by pressing the corresponding character.
- Images are only for illustrative purposes.

▶ Printing the Pictograph List

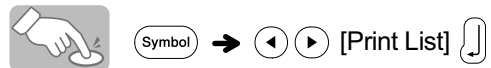

Label image

A	☎	📅	📞	✉	👂	👃	👄	👅
B	📅	📞	✉	👂	👃	👄	👅	

Designing Labels

1 Press **(Fn)**, use **(◀ ▶)** to select a function under column [A], and then press **(↓)**. (You can also select the function with the shortcut keys listed under column [C]. **(Fn + ¹Q** to **⁵T**))

2 Use **(◀ ▶)** to select a setting listed under column [B], and then press **(↓)**.

Design	[A]	[B]	Label image	[C]
Size	Size	Large* ¹	J.SMITH	(Fn) +
		Small	J.SMITH	¹ Q
Width	Width	Normal* ¹	J.SMITH	(Fn) +
		x2	J.SMITH	² W
		x1/2	J.SMITH	
Style	Style	Normal* ¹	J.SMITH	(Fn) +
		Bold	J.SMITH	
		Outline	J.SMITH	
		Shadow	J.SMITH	
		Italic	J.SMITH	
		Italic Bold	J.SMITH	
		Italic Outline	J.SMITH	
		Italic Shadow	J.SMITH	
		Vertical	ㄋ · ∫ Σ - ⊥ ⊥	
Under-line/ Frame	Und/ Frame	Off* ¹	ABC	(Fn) +
		Underline	ABC	
		Round	ABC	
		Leaf	ABC	
		Tile	ABC	
		Star	ABC	
		Heart	ABC	
		Square	ABC	
		Bubble	ABC	
		Flower	ABC	
		Candy	ABC	
Label length	Length	Auto* ¹ /1.2" - 12.0" (30mm - 300mm)* ²	The label is printed with the specified length.	(Fn) + ⁵ T

*¹ Default setting. To return to the default setting, press **(Space)**.

*² To select the length, enter the length with the Number Keys **¹Q** ~ **⁰P**. To return to [Auto], press **(Space)**.

Adding Deco Mode Patterns

This function allows you to create unique labels using built-in templates. You can select from eight types of templates.

Design	Label Image	Cooling
1	ABC ABC ABC ABC	
2	ABC ABC ABC ABC	
3	ABC ABC ABC ABC ABC ABC ABC ABC	
4	ABC ABC ABC ABC ABC ABC ABC ABC	
5	ABC ABC ABC ABC ABC ABC ABC ABC	
6	ABC ABC ABC ABC ABC ABC ABC ABC	may occur
7	ABC ABC ABC ABC ABC ABC ABC ABC	
8	ABC ABC ABC ABC ABC ABC ABC ABC	

Example: Design 8



DECO → (◀ ▶) [Design 8] (↓)

→ Label Length → (◀ ▶) [Auto/1.2"-7.8"

(30-200mm)] (↓) → ABC (↓)

→ (◀ ▶) [Print] (↓)

NOTE

- Some DECO MODE formats may need cooling (indicated on the above table). If the print head becomes too hot, your label maker stops printing and automatically starts to cool down. The cool down time is displayed. When the print head is cool, printing automatically continues. Do not touch the label maker while cooling.
- You can enter only one line of text in DECO MODE.
- Depending on the selected format, the entire text entered may not be printed.
- You cannot change the formats of the DECO MODE templates.
- Symbols surrounded by a box in the Basic table are available in DECO MODE. For the Basic table, see "Adding Symbols".
- To clear all the entered text, press **(Shift)** and **(ES)** at the same time. "Clear?" is displayed. Press **(↓)** to clear the text, or **(ES)** to cancel this operation.
- When you access DECO MODE, your most recently printed DECO MODE text and label length are recalled.
- Press **(ES)** to return to the previous step.
- To exit DECO MODE, press **(ES)** until the display returns to the text entry screen. You can also exit this mode by pressing **(◀ ▶)** when [Print] is displayed, and selecting [Quit].
- We recommend 0.47" (12mm) wide tape cassettes when using the DECO MODE feature.
- The maximum label length is 7.8" (200mm) for DECO MODE.
- When you select [Auto] for [Label Length], the label automatically adjusts to the correct length for printing the text one time.
- Press **(Space)** to return to [Auto] for [Label Length] mode.

Printing Labels

► Text Preview

You can preview the text before printing.



- The LCD displays the whole text and the label length (inch/mm), then returns to the original text.
- You can only preview the text. Style, size, underline, frame, or any additional features cannot be previewed.

► Feeding (Tape Feed)



This function will feed approximately 1" (25mm) of blank tape.

► Printing



- To prevent damage to the tape, do not touch the cutter lever while the message "Printing..." or "Feeding..." is displayed.
- To cut off the label, push in the tape cutter lever on the upper-left corner of the label maker.
- Peel the printed label from the label backing and apply the label.

► Printing multiple copies (Fn + Print)

You can print up to 9 copies of each label.

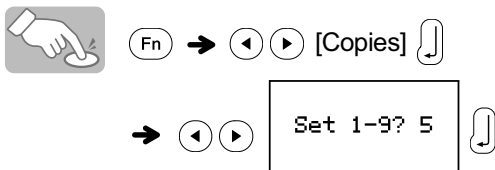

- You can also select the number of copies by entering with the Number Keys ¹Q ~ ⁹O.

► Removing the Label Backing

This label maker is equipped with a peeler that allows you to remove the backing from labels.

1. Insert the label, with the printed surface facing down, as far as possible into the built-in peeler.
2. Fold back the label to the right and quickly pull out the label. The end of the backing is slightly separated from the label.
3. Peel the printed label away from the label backing and apply the printed label.

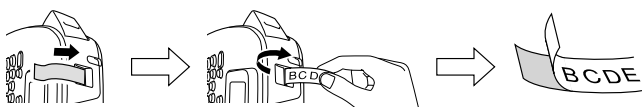

Saving Label Files

► Memory (Fn + U)

You can save your original labels on to your label maker. Up to 3 labels can be saved and recalled for printing at a later time. You can also edit and overwrite the stored label.

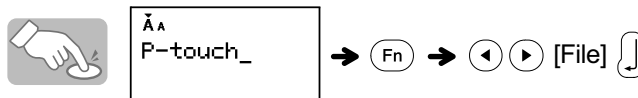

To Save: → ← → [Save] →

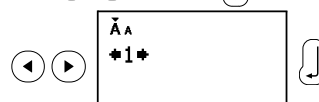

To Print: → ← → [Print] →

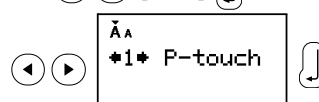

To Open: → ← → [Open] →

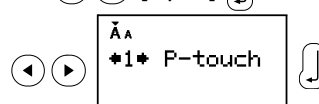

NOTE

If you try to store a label when there is already a label stored to that number, a message "Overwrite?" appears. Press to save your new label. Press to cancel.





Resetting the label maker

You can reset the label maker when you want to restore it to factory settings, or in the event that the label maker is not working correctly.



- 1 Press to turn off the power.
- 2 While holding down and ⁴R, press to turn on the power.
- 3 Release , and then release and ⁴R. The internal memory is reset, and all text, settings and stored files are cleared.

Troubleshooting

► Error message

Message	Cause/Remedy
Low Battery!	The batteries are weak. Replace them with four new AAA alkaline batteries. Do not use old and new batteries together or mix alkaline batteries with other battery types.
Full!	You have already entered the maximum number of characters allowed (80 characters for regular text, or 50 characters for DECO MODE).
No Text!	<ul style="list-style-type: none"> You tried to print a text file when there is no data stored in the memory. You pressed  when no text is entered. You pressed  when no text is entered. You tried to select [Copies] when no text is entered. You pressed  when no text is entered in the text entry screen of DECO MODE.
Line Limit!	You tried to enter a third line by pressing  (Maximum printable lines is two).
Invalid!	You selected an invalid number for [Label Length].
Text Limit!	<ul style="list-style-type: none"> The text length exceeds the selected label length. The text length exceeds 7.8" (200mm) when you set [Label Length] to [Auto] in DECO MODE. If you select the minimum label length (1.2"/30mm), some frame types (Leaf or Star) do not allow you to enter additional text.
Cooling XXX	If the print head becomes too hot, your label maker stops printing and automatically starts to cool down. The cool down time is displayed. When the print head is cool, printing automatically continues. Do not touch the label maker while cooling.

► What to do when...

Problem	Solution
The display stays blank after you have turned on the label maker.	<ul style="list-style-type: none"> Check that you installed the batteries correctly with the positive and negative ends in the correct position. If the batteries are weak, replace them with four new AAA alkaline batteries. Do not use old and new batteries together or mix alkaline batteries with other battery types.
The label maker does not print, or the printed characters are not formed correctly.	<ul style="list-style-type: none"> Check that you have inserted the tape cassette correctly. If the tape cassette is empty, replace it. Check that you closed the cassette cover correctly.
The label maker's settings have cleared on its own.	<ul style="list-style-type: none"> The batteries may be weak. Replace them with four new AAA alkaline batteries. Do not use old and new batteries together or mix alkaline batteries with other type batteries. When power is disconnected for more than three minutes, all text, format settings, and any text files stored in the memory are cleared. Language and Unit settings are also cleared.
A blank horizontal line appears through the printed label.	There maybe some dust on the print head. Remove the tape cassette and use a dry cotton swab to gently wipe the print head with an up-and-down motion.
The label maker has "locked up" (that is, nothing happens when you press a key, even though the label maker is on.)	See "Resetting the label maker".
The power turns off when you try to print.	<ul style="list-style-type: none"> The batteries may be weak. Replace them with four new AAA alkaline batteries. Do not use old and new batteries together or mix alkaline batteries with other battery types. Check that you inserted the batteries correctly.
The tape does not feed correctly or the tape gets stuck inside the label maker.	<ul style="list-style-type: none"> Remove the M tape from the label maker and ensure the tape feeds under the tape guides. You used the cutter lever while printing. Do not touch the cutter lever while the message "Printing..." or "Feeding..." is displayed.
All text and format settings must be cleared to create a new label.	Press  while holding down  , or go into Function mode and select  .
To change language setting	See "Initial Settings".

Specifications

Dimensions: (W × D × H) Approx. 6.14" × 4.37" × 2.40"
(Approx. 156 × 111 × 61mm)

Power supply: Four AAA alkaline batteries (LR03)

Weight: Approx. 0.6 lb. (Approx. 250 g)
(without batteries and tape cassette)

Tape cassette: Brother P-touch M tape widths: 0.35" (9mm),
0.47" (12mm)

See the attached "Supplies and Accessories Guide" for more information of tape variation.

Should you encounter any problems with your product, please do not return your product to the store!

After referring to the User's guide, if you still need assistance, contact Brother Customer Service at:

Voice: 1-877-BROTHER

Web: www.brother-usa.com

Fax: 1-901-379-1210

If you need to locate a service center, please call
1-877-BROTHER or visit www.brother-usa.com