



bestchoiceproducts



INSTRUCTION MANUAL

7.5-Foot Solar Patio Umbrella

Ver. 1

SKY5734 + SKY5735 + SKY5736 + SKY5737 + SKY5738
SKY5739 + SKY5740 + SKY5741 + SKY5742 + SKY5743



bestchoiceproducts

As shoppers, we're always trying to find the perfect balance between quality & value. At BCP, we believe we've achieved that. Our diverse catalog of everyday essentials is tailored especially to our customers & guaranteed to hit that sweet spot of high quality & low price.

— Always. —



Solar panel
requires 6 to 7
hours of direct
sunlight to
fully charge.



! NOTICE

Please retain these instructions for future reference.

- Umbrella stand is not included. Do not use this umbrella without an umbrella stand.
- Umbrella is suitable for rain showers and light wind.
- Do not use umbrella in inclement weather, such as snow, heavy rain, thunderstorms, or strong wind.
- Always remove umbrella from its stand/table when not in use.
- If using the umbrella with a table, make sure the plastic umbrella ring is inserted into the hole in the center of the table.
- If any parts are missing, broken, damaged, or worn, stop using this product until repairs are made and/or factory replacement parts are installed.
- Do not use this item in a way inconsistent with the manufacturer's instructions as this could void the product warranty.



1 PERSON
ASSEMBLY



UP TO 15 MIN.
ASSEMBLY

PARTS

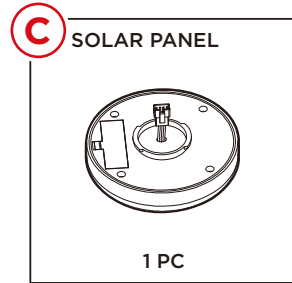
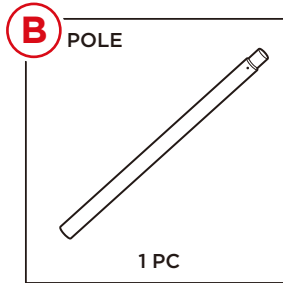
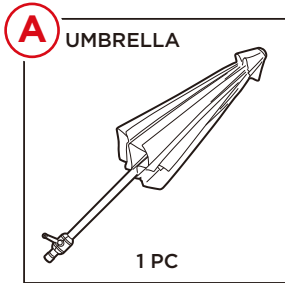

BEFORE FIRST USE

1. Hold the umbrella upside down and shake gently to separate the umbrella ribs. If necessary, carefully pull the ribs apart to free them.
2. Slowly turn the crank to open the umbrella. Make sure that the ribs are not stuck together.

PRODUCT ASSEMBLY

1

Connect the wire from the part A umbrella to the corresponding connector on the part C solar panel. Attach the solar panel to the umbrella.

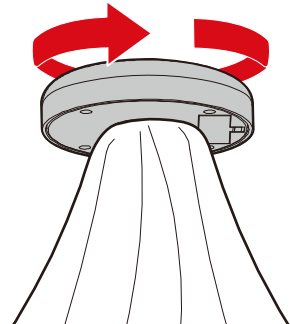
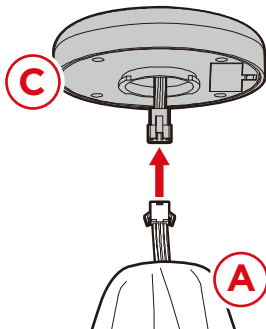

PRODUCT ASSEMBLY

2

Screw the part B pole into the part A umbrella.

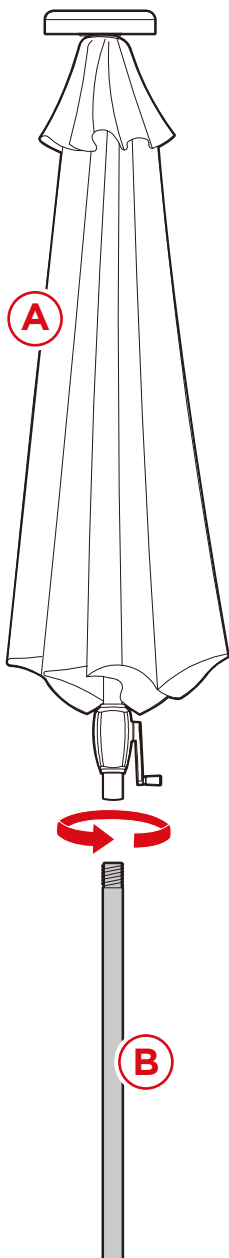

3

Insert the umbrella into an umbrella stand (not included).

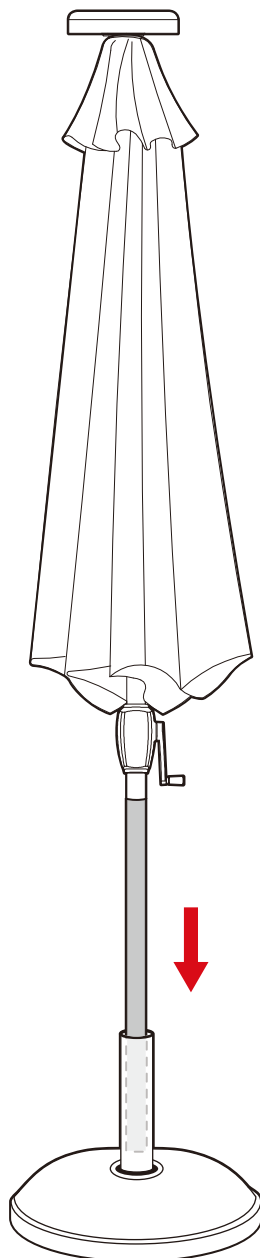

PRODUCT ASSEMBLY

4

Slowly turn the crank to open the umbrella canopy. Press the button to adjust the tilt to your desired position. Press power switch to turn on LED lights.

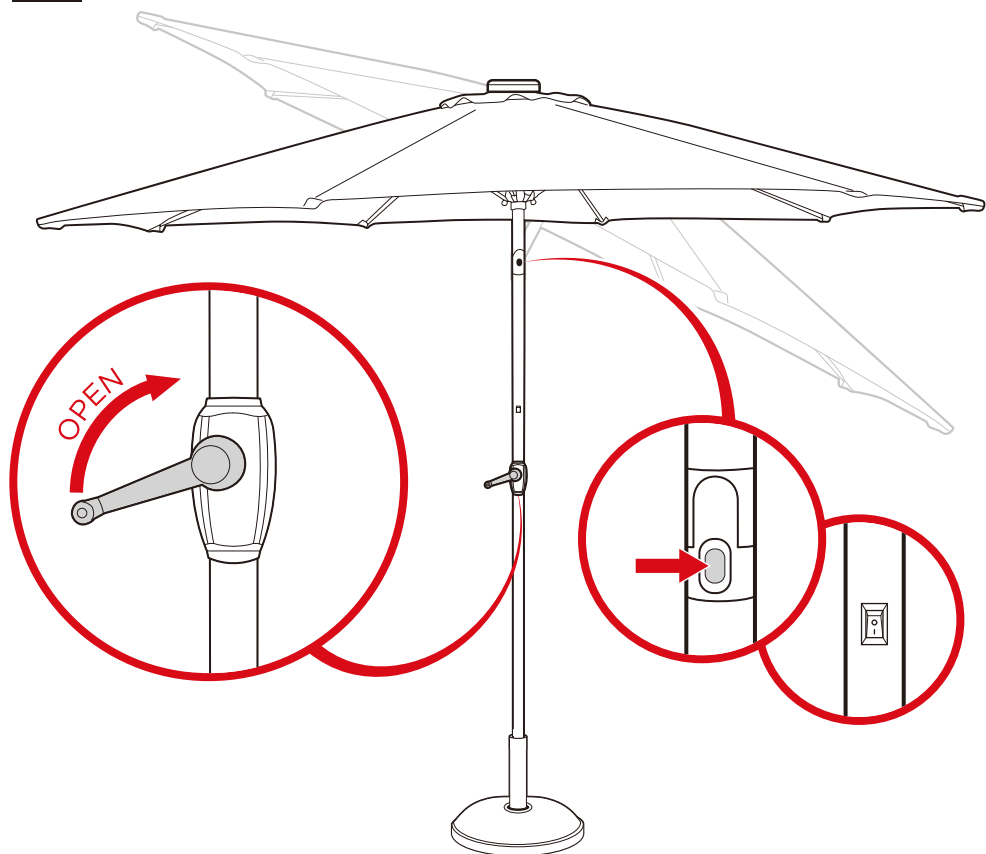

CHARGING THE LIGHTS

- Solar panel requires 6 to 7 hours of direct sunlight to fully charge.
- LED lights last for 6 to 7 hours on a single charge.
- If lights are not working, fully charge the solar panel and try again.

CLEANING AND STORAGE

- Wipe clean with mild detergent, warm water, and a soft cloth.
- Do not use abrasive materials or cleaners.
- Store in a dry area shielded from the weather.
- If necessary, cover with a furniture cover or tarp.

Earn points while you shop. Join today!

bestchoiceproducts
rewards

Join | Earn | Redeem

Give your friends 15% off their first order! For each successful referral you'll receive 100 points.

bestchoiceproducts.com



HELP CENTER



Question about your product? We're here to help. Visit us at:

help.bestchoiceproducts.com



Chat Support



Product Inquiry



Orders FAQ



Product Assembly



Returns & Refunds

PRODUCT WARRANTY INFORMATION

All items can be returned for any reason within 60 days of the receipt and will receive a full refund as long as the item is returned in its original product packaging and all accessories from its original shipment are included. All returned items will receive a full refund back to the original payment method. All returned items will not be charged a re-stocking fee.

All returned items require an RA (Return Authorization) number, which can only be provided by a Best Choice Products Customer Service Representative when the return request is submitted. Items received without an RA may not be accepted or may increase your return processing time. Once an item has been received by Best Choice Products, refunds or replacements will be processed within 5 business days.

All returns must be shipped back to the Best Choice Products Return Center at the customer's expense. If the reason for return is a result of an error by Best Choice Products then Best Choice Products will provide a pre-paid shipping label via email. Boxes for return shipping will not be provided by Best Choice Products, and is the customer's responsibility to either use the original shipping boxes or purchase new boxes.

Pictures may be required for some returns to ensure an item is not damaged prior to its return. Items returned are not considered undamaged until they are received by Best Choice Products and verified as such. All damages to items are the customer's responsibility until the item has been received by and acknowledge by Best Choice Products as undamaged.



WARNING

Manufacturer and seller expressly disclaim any and all liability for personal injury, property damage or loss, whether direct, indirect, or incidental, resulting from the incorrect attachment, improper use, inadequate maintenance, or neglect of this product.