







HEKMAN®

A HOWARD MILLER COMPANY

28540 CONSOLE TABLE TWO DRAWERS

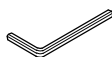
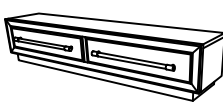
HARDWARE LIST					
A	B	C	D	E	
ALLEN BOLT M6 X 20 (8 PCS)	FLAT W. M6 (8 PCS.)	LOCK W. M6 (8 PCS.)	BOLT M4 x 15 mm (FOR STRETCHER) (2 PCS.)	ALLEN KEY L4 (FOR ALLEN BOLT) (1 PC.)	
					

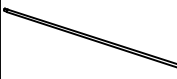
PART INSIDE		
1	2	3
TOP ASSEMBLY (1 Pc)	END ASSEMBLY (2 Pcs)	STRETCHER (1 Pc)
		

Assembly Instruction

STEP 1:

PLACE STRETCHER (3) IN POSITION AND ATTACH TO END ASSEMBLY (2) WITH BOLT (D) USING SCREW DRIVER (NOT INCLUDED).

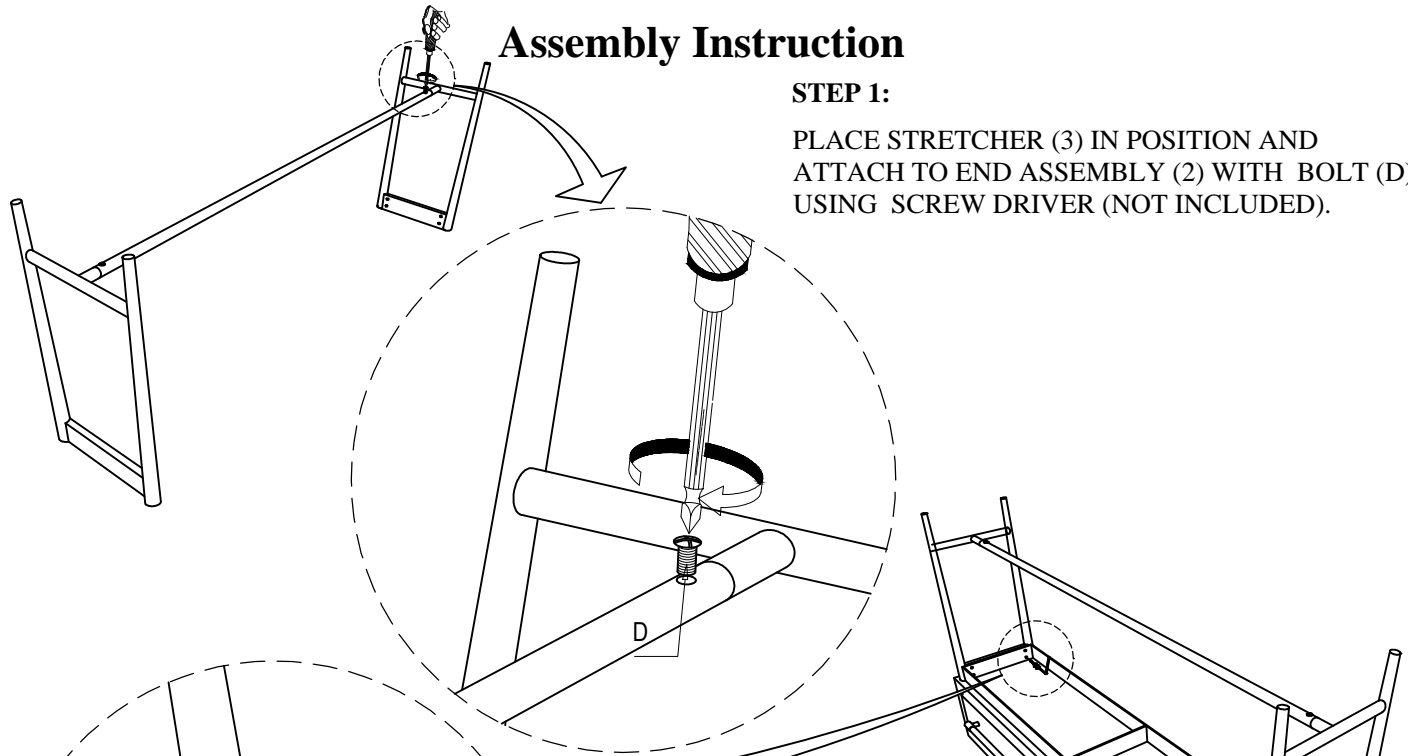

STEP 2.

LAY TOP ASSEMBLY (1) UPSIDE DOWN ON A SOFT, CLEAN AND FLAT SURFACE. ALIGN THE HOLES IN THE TOP RAIL OF THE END ASSEMBLIES WITH THE INSERT IN THE APRON RAIL OF THE TOP ASSEMBLY. CONNECT USING FLAT WASHER (B), LOCK WASHER (C), ALLEN BOLT (A) AND ALLEN KEY (E).

