

98.8
75.2

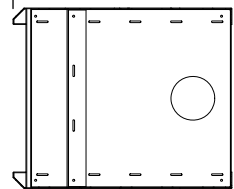

300
Section A-A

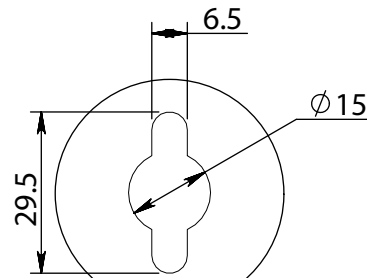
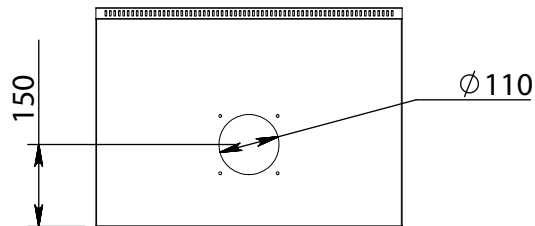
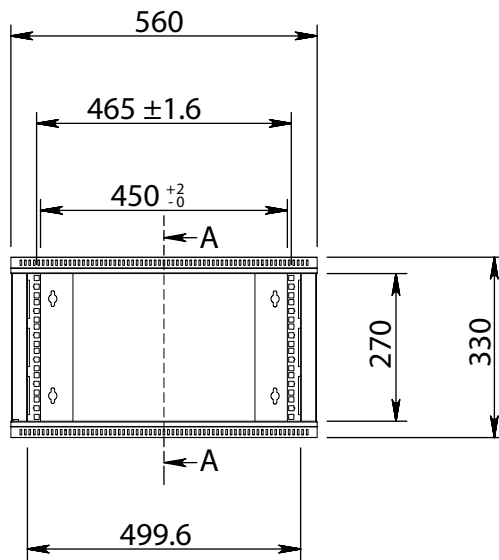
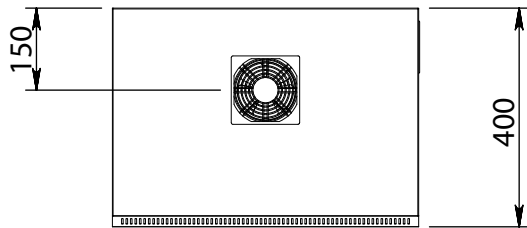
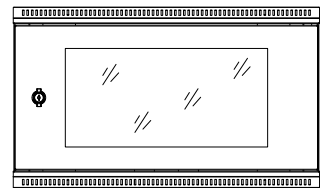

Detail B

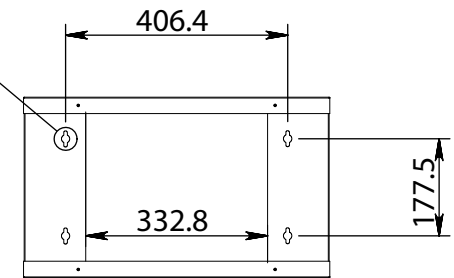
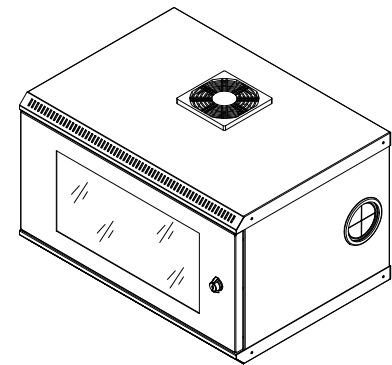
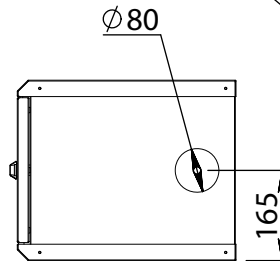

THIRD ANGLE PROJECTION

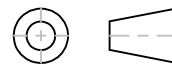

GENERAL NOTES

DIMENSIONS ARE IN MM - DO NOT SCALE
THIS DOCUMENT CONTAINS CONFIDENTIAL,
PROPRIETARY INFORMATION THAT IS
PROPERTY OF STARTECH.COM

StarTech.com

PRODUCT ID	RK619WALL (V2)
DESCRIPTION	2-Post 6U Wall Mount Network Cabinet with Acrylic Door, 19" Wall-Mounted Server Rack for Data / AV / Electronics / Computer Equipment, Small Vented Rack Enclosure
DO NOT SCALE	SHEET: 1 OF: 1
	UPLOAD DATE: 1/24/2024