

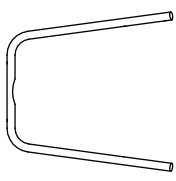

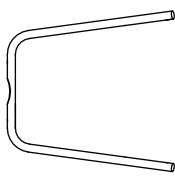
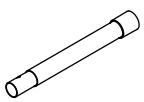
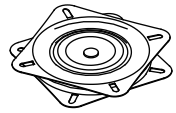
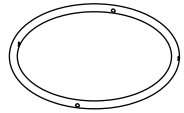
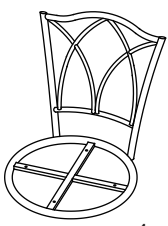
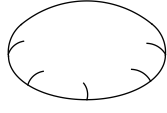
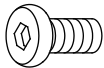
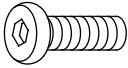
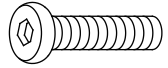
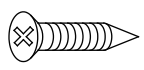

ASSEMBLY INSTRUCTION

855C972W(3A) BARCELONA 3 PACK BARSTOOL

A Upper 'U' Tube  1 pc	B Lower 'U' Tube  1pc	C Leg Extension  4pcs	D Swivel  1pc	E Ring  1pc
F Upper Frame  1 pc	G Seat Cushion  1pc	H Bolt 1/4", 12mm  8pcs	I Bolt 1/4", 19mm  4pcs	J Bolt 1/4", 32mm  4pcs
K Screw 3/16", 25mm  4 pcs	L Spring Washer  8pcs	M Metal Washer  8pcs	N Allen Wrench  1pc	O Foot Pad  4pcs

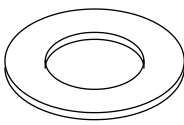

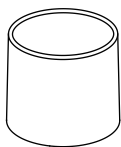
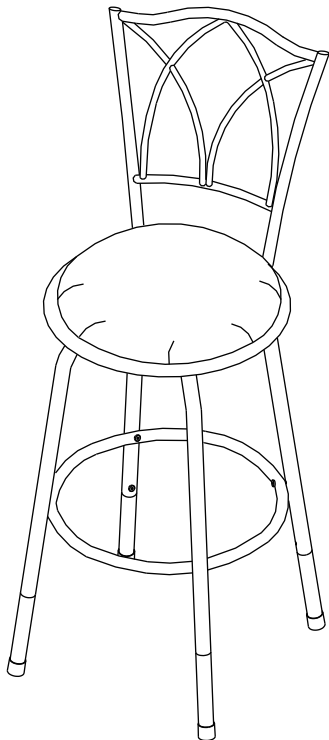
This page lists all the contents included in the box. Please take the time to identify the hardware as well as the individual components to this product. As you unpack and prepare for assembly, place the contents on a carpeted or padded area to protect them from damage.

Note

The stool has adjustable legs and it is universal 24 or 30 inch . If you need 24 inch barstool , please do not install leg extension "C" , just attach foot pad "O" to the bottom of upper/lower 'U' tube "A" & "B".

855C972W(3A) BARCELONA 3 PACK BARSTOOL

1

(For 30 inch seat height stool) Insert Leg Extension (C) into the bottom of Upper/Lower 'U' Tube (A) & (B). Make sure Leg Extension hole is aligned with the holes of Upper/Lower 'U' Tube (A) & (B), insert Bolt (H) into the lower holes, and firmly tighten using Allen Wrench (N).

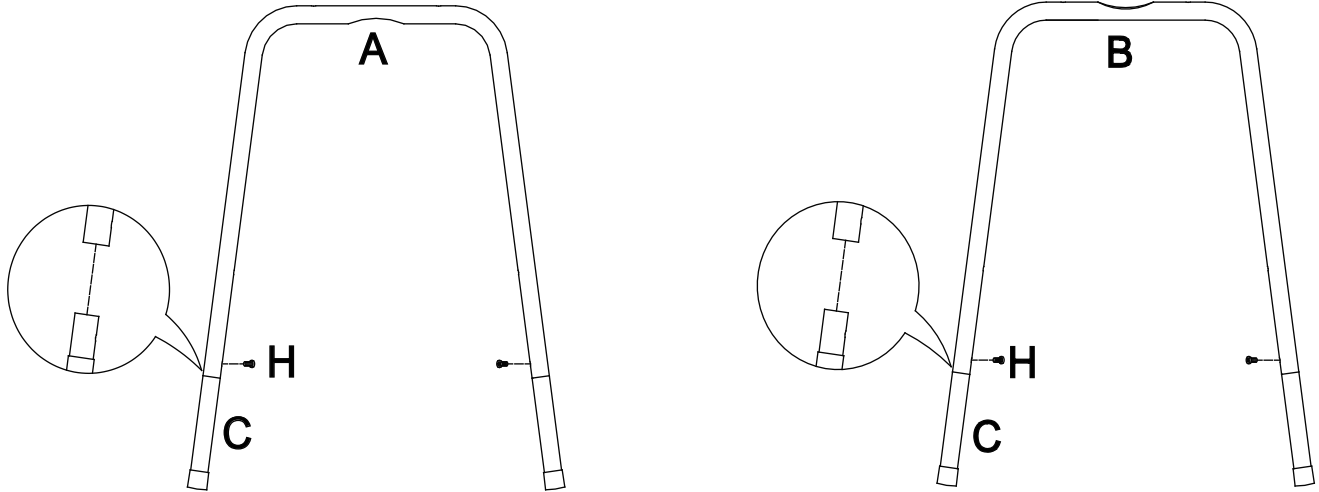

2

1. Put Upper 'U' Tube (A) into the groove of Lower 'U' Tube (B).
2. Turn the Swivel (D) 45 degrees (as picture shown) for easy assembly, then put it on Upper/Lower 'U' tube (A) & (B), align the holes and firmly tighten with hardware (I), (L), (M) using tool (N).

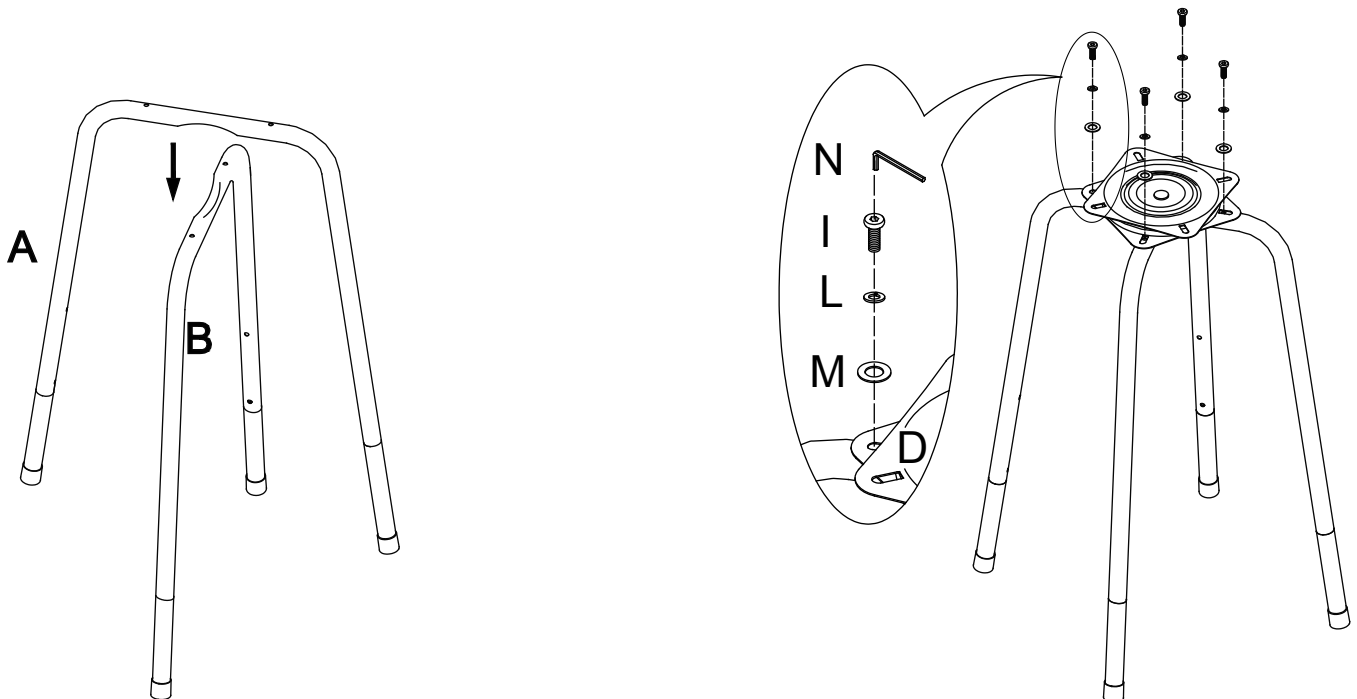

855C972W(3A) BARCELONA 3 PACK BARSTOOL

3

1. Attach Ring (E) to Upper/Lower 'U' Tube (A) & (B) and align the holes of Ring (E) with the upper holes of Upper/Lower 'U' Tube (A) & (B), then firmly tighten with hardware (J) using fool (N).
2. Put the assembled stool base up-side -down on Upper Frame (F), align holes of Swivel (D) with the holes of Upper Frame (F) and firmly tighten them with hardware (H), (L), (M) using fool (N).

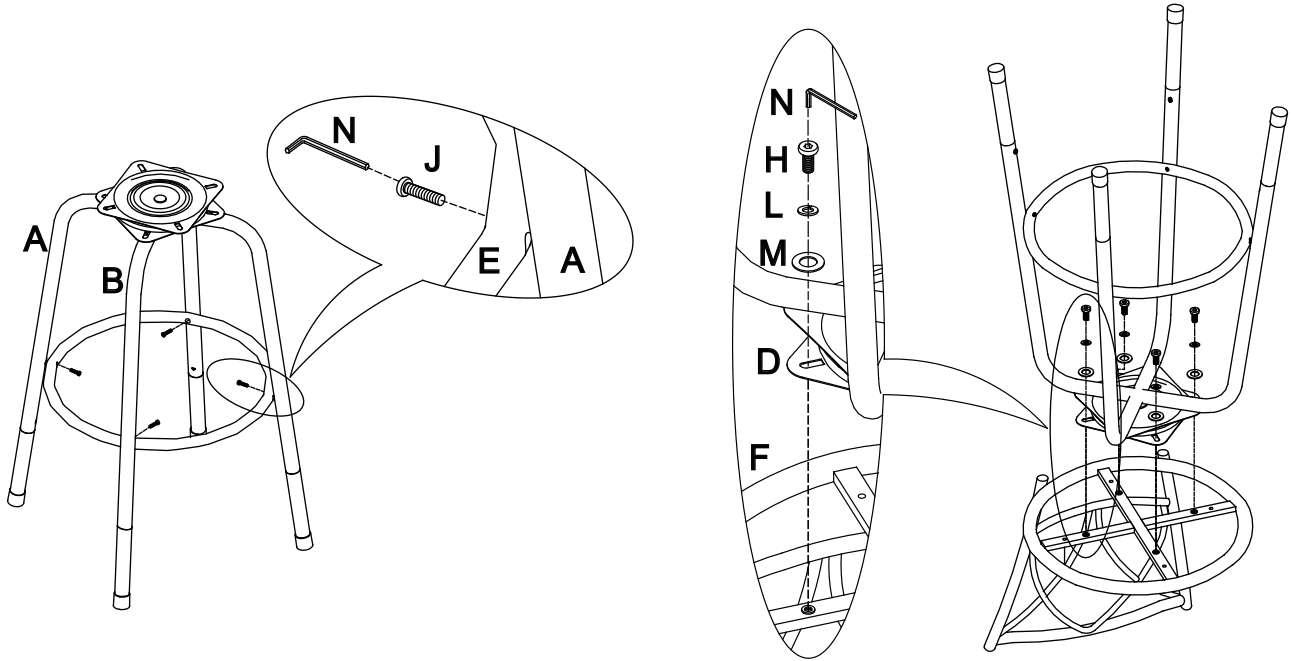

4

1. Attach Seat Cushion (G) to Upper Frame (F) with hardware (K), firmly tighten with stool (Not provided), then turn the barstool upright.
2. It is recommended to tighten all bolts every 3 months.

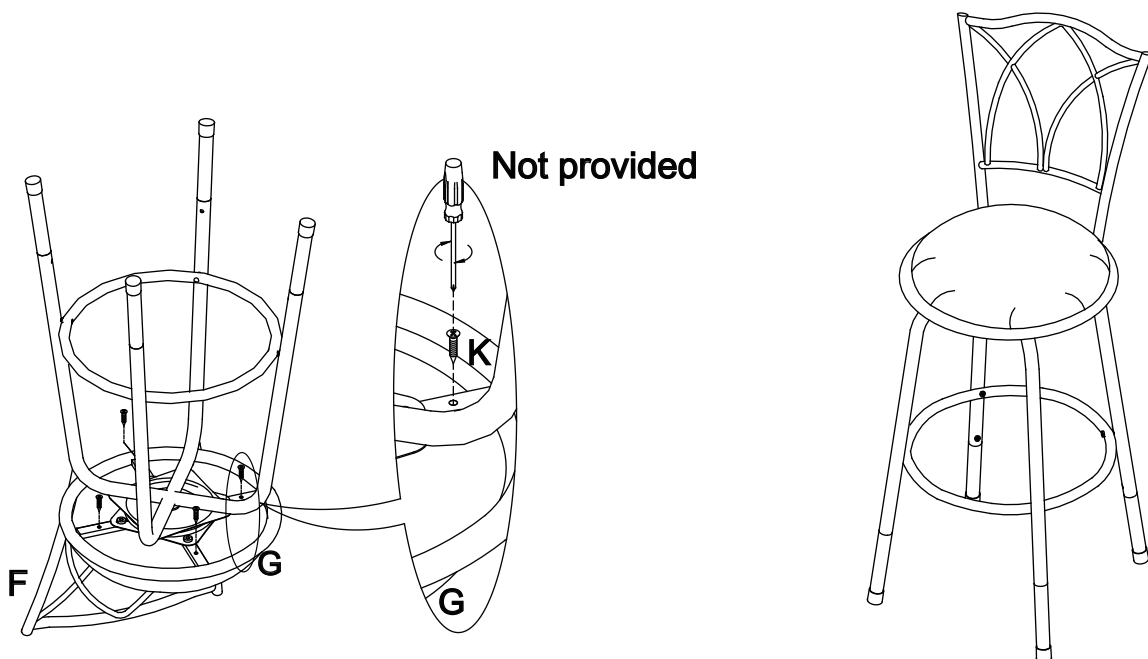

Cleaning & Care

Treat surface with care. Surface is resistant to scratches but is not scratch resistant. Clean surfaces with a dry or damp soft cloth. Do not use abrasive cleaners. Hardware may loosen over time. Periodically check that all connections are tight.