

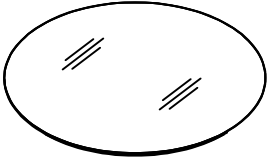

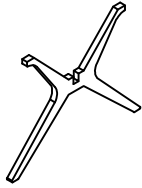

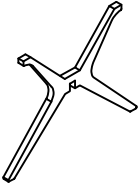

ASSEMBLY INSTRUCTION

TRESTLE ROUND GLASS TABLE

A Table Top  1 pc	B Lower Leg Frame  1 pc	C Upper Leg Frame  1 pc	D Allen Bolt Ø5/16"x65mm  1 pc
E Allen Bolt Ø5/16"x40mm  4 pcs	F Lock Washer Ø5/16"x11mm  5 pcs	G Flat Washer Ø5/16"x 19 mm  5 pcs	H Allen Key 4 mm  1 pc

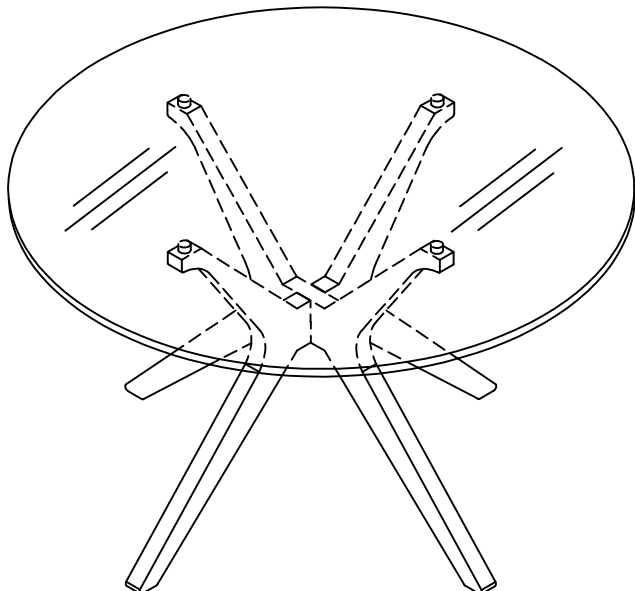

This page lists all the contents included in the box. Please take the time to identify the hardware as well as the individual components to this product. As you unpack and prepare for assembly, place the contents on a carpeted or padded area to protect them from damage.

1 Attached Lower Leg Frame(B) to Upper Leg Frame(C). Use Allen Bolt(D) Lock Washer(F) and Flat Washer(G) on holes of Leg Down(C). Turn the Allen Key(H) in Allen Bolt(D).

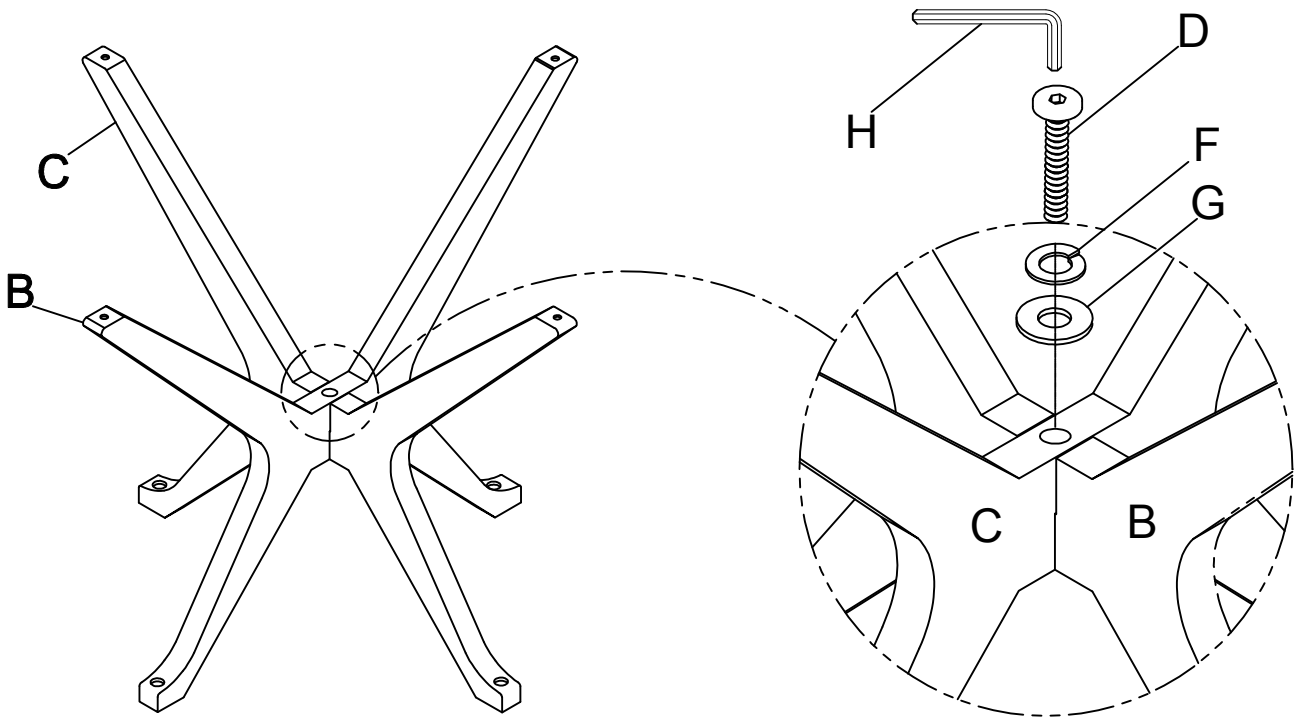

2 Attached Leg Up(B) and Leg Down(C) to the Table Top(A). Use Allen Bolt(E) Lock Washer(F) and Flat Washer(G) on holes of Table Top(A). Turn the Allen Key(H) in Allen Bolt(E).

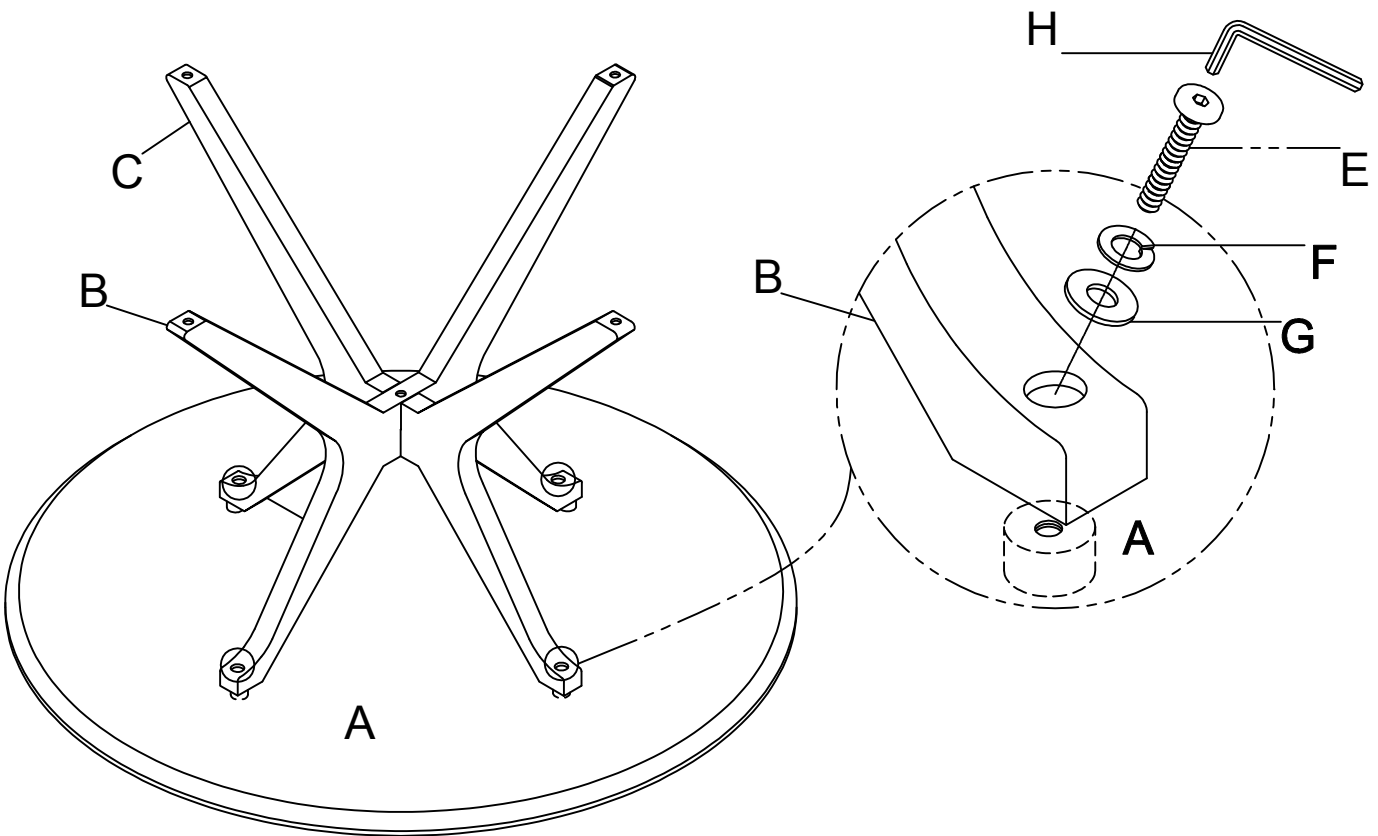

3

Adjusted the Leveler at the bottom of Leg(B,C), to keep the table level.

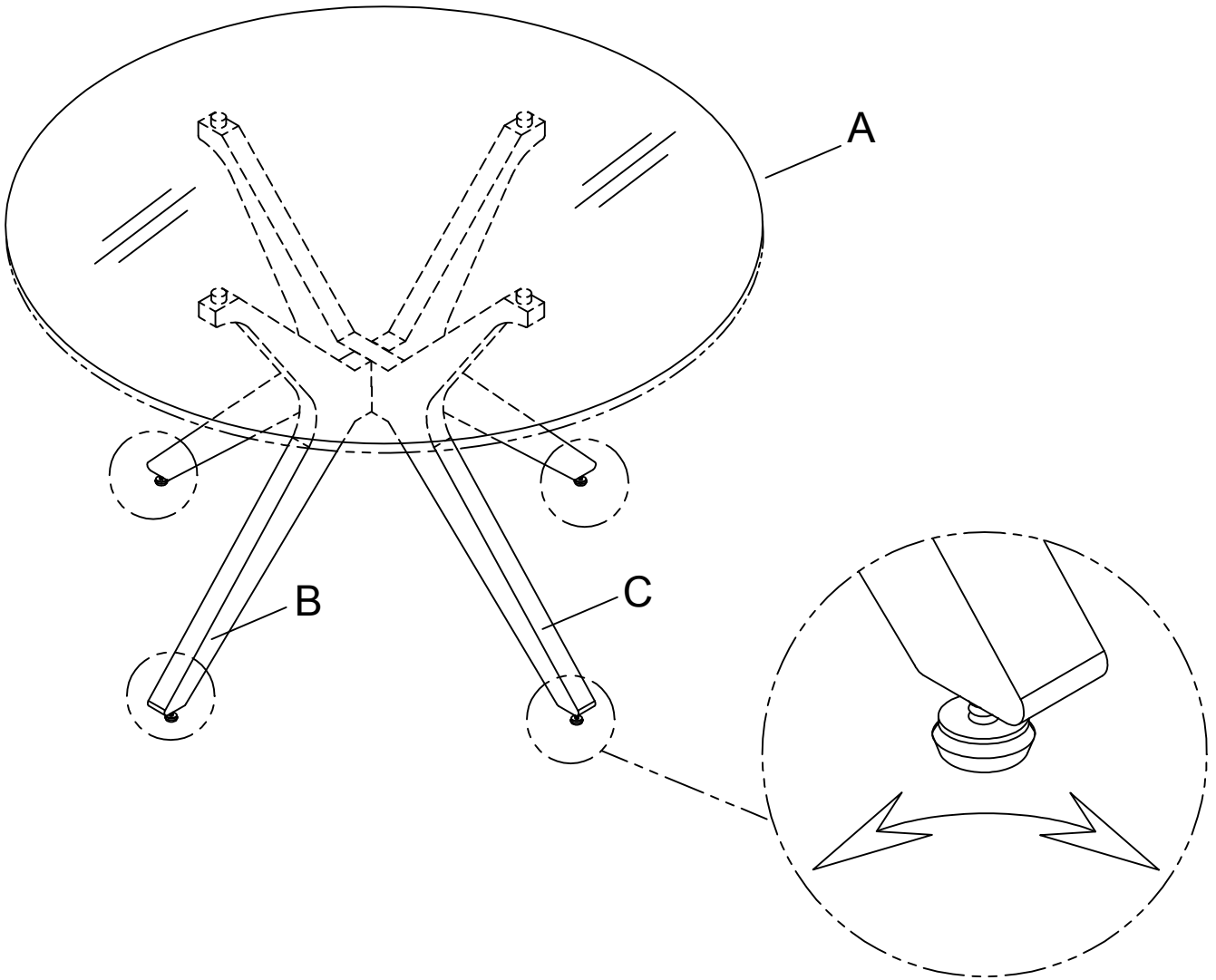

Cleaning & Care

Treat surface with care. Surface is resistant to scratches but is not scratch resistant. Clean surfaces with a dry or damp soft cloth. Do not use abrasive cleaners. Hardware may loosen over time. Periodically check that all connections are tight.