

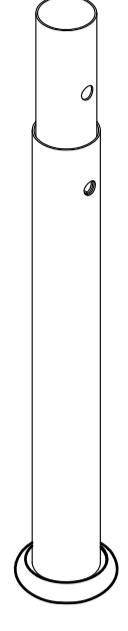

ASSEMBLY INSTRUCTION

METAL QUEEN BED

A Headboard Leg  2PCS	B Headboard  1PC	C Footboard  1PC	D Rail Section  2PCS
E Rail Section  2PCS	F Front / Rear Support Bar  2PCS	G Center Support Bar  1PC	H Front Center Rail  1PC
I Rear Center Rail  1PC	J Rail Support Legs  2PCS	K Center Support Legs  3PCS	L Slat  16PCS
M Slat Connector  32PCS	N Bolt 1/4"*16mm  24PCS	O Bolt 1/4"*46mm  8PCS	P Bolt 1/4"*36mm  2PCS
Q Nut 1/4"  6PCS	R L-Allen Key 4mm  1PC	S Wrench 5/16" - 1/4"  1PC	

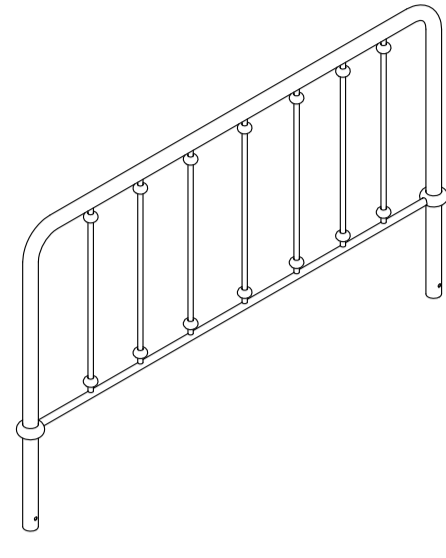
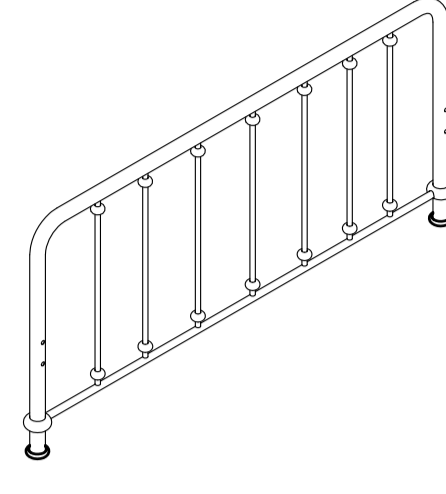
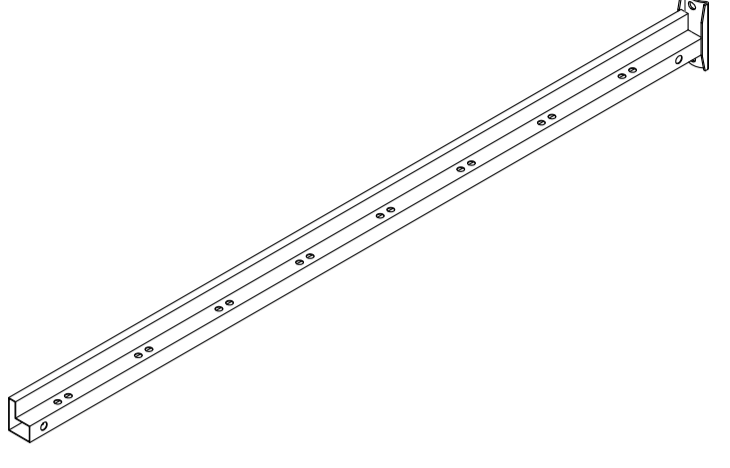
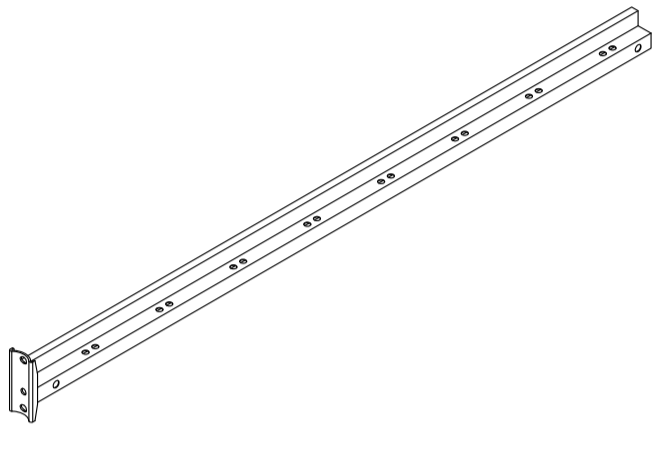
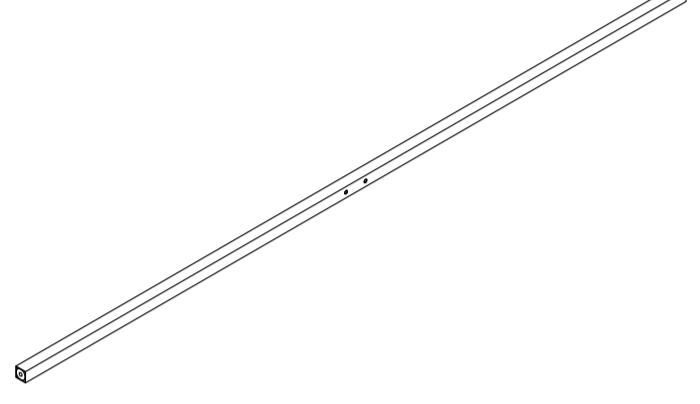
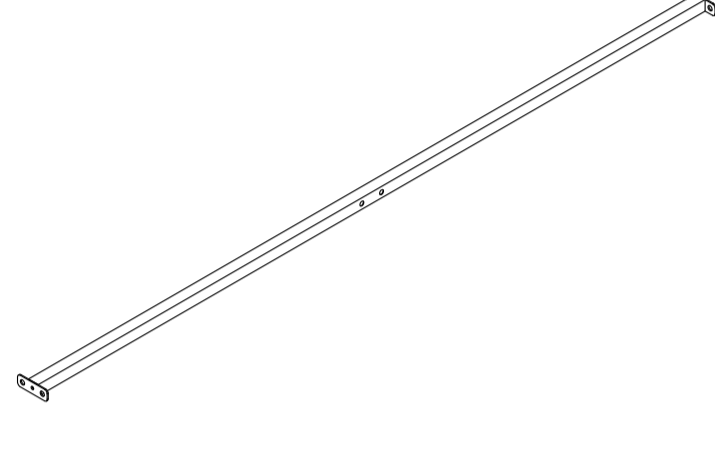
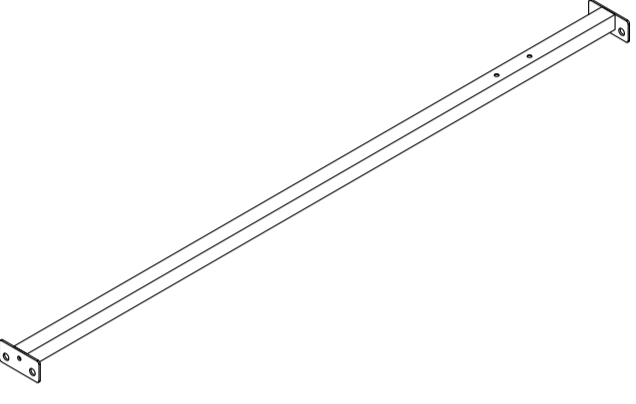
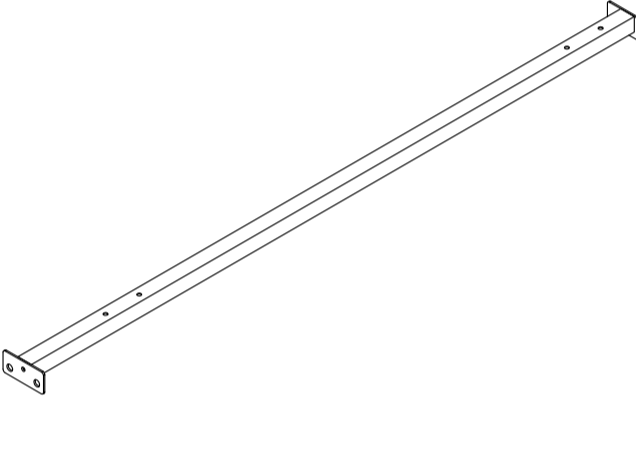
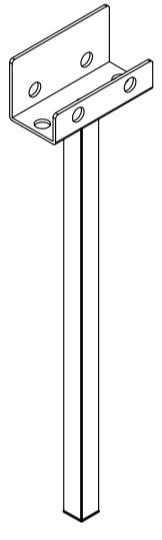
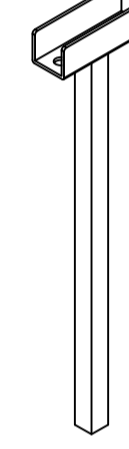
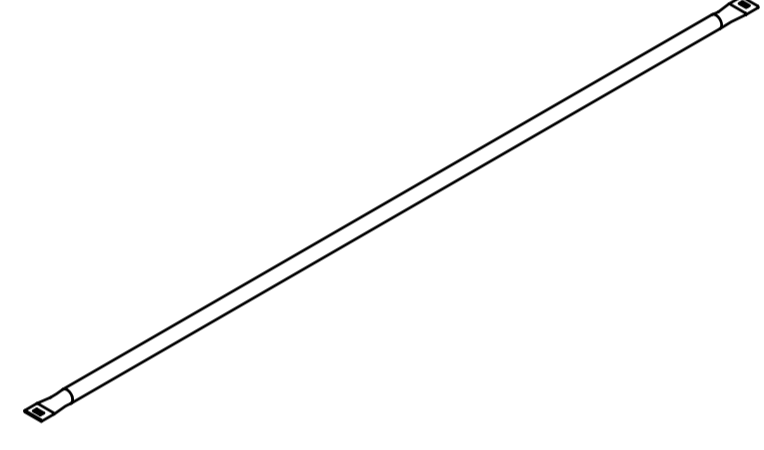
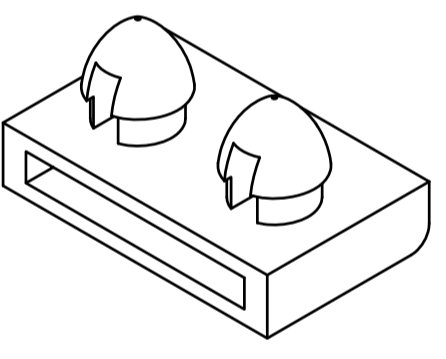
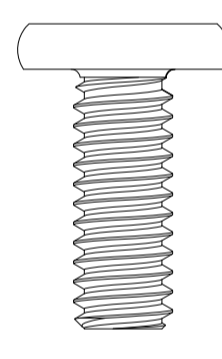
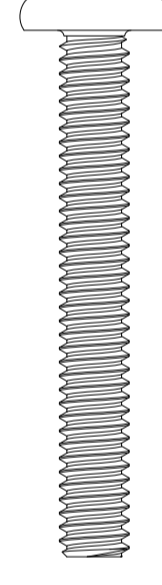
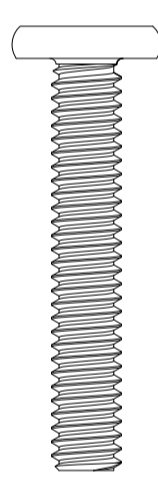
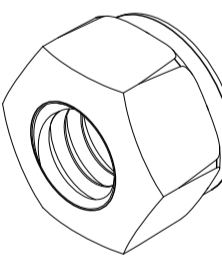

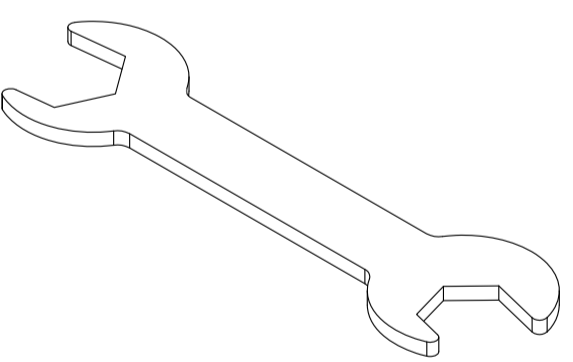
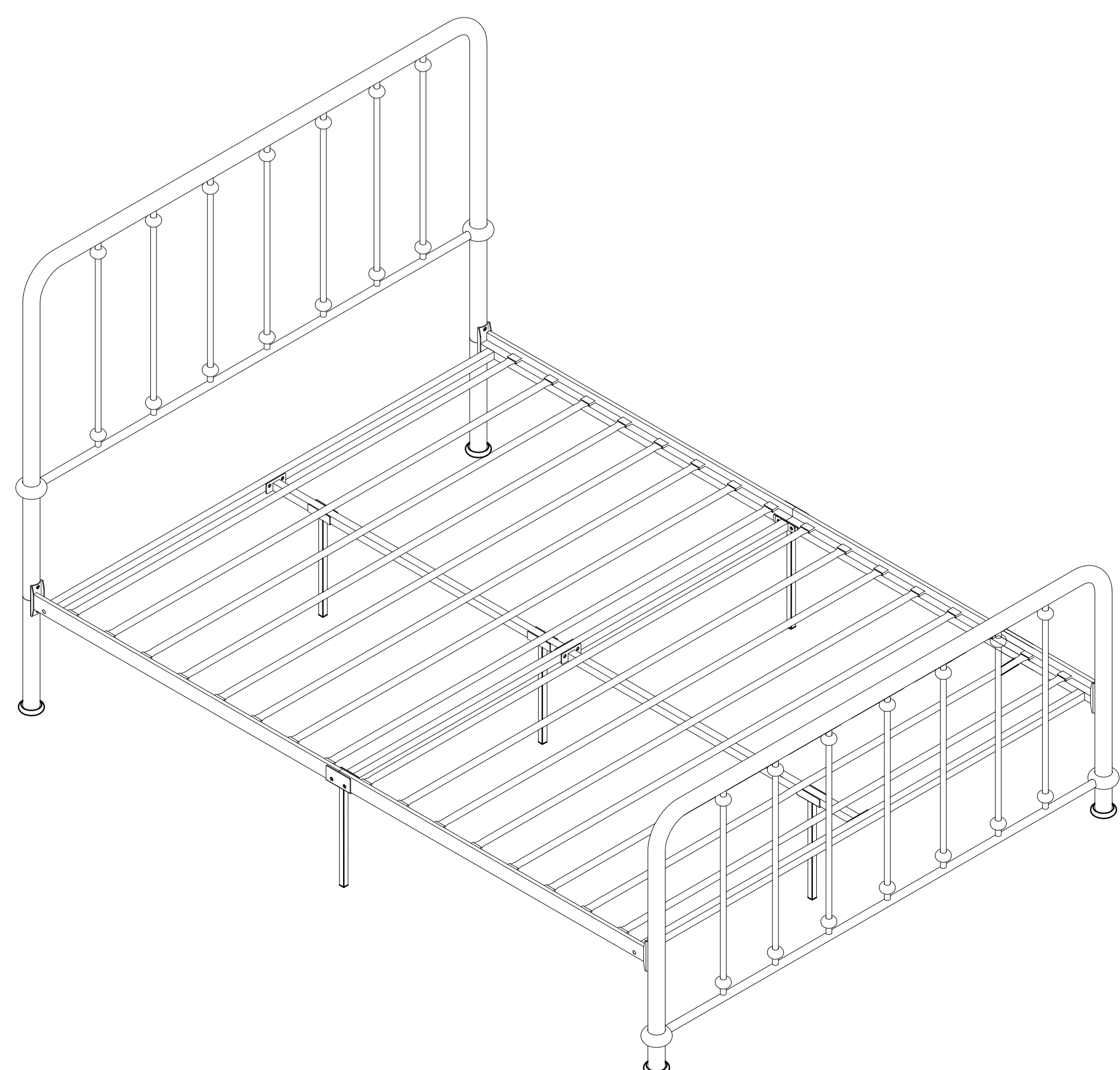
This page lists all the contents included in the box. Please take the time to identify the hardware as well as the individual components to this product. As you unpack and prepare for assembly, place the contents on a carpeted or padded area to protect them from damage.

1

Attach the Headboard Leg (A) to the Headboard (B), insert the Bolt (N), turn the L-Allen Key (R) to tighten them.

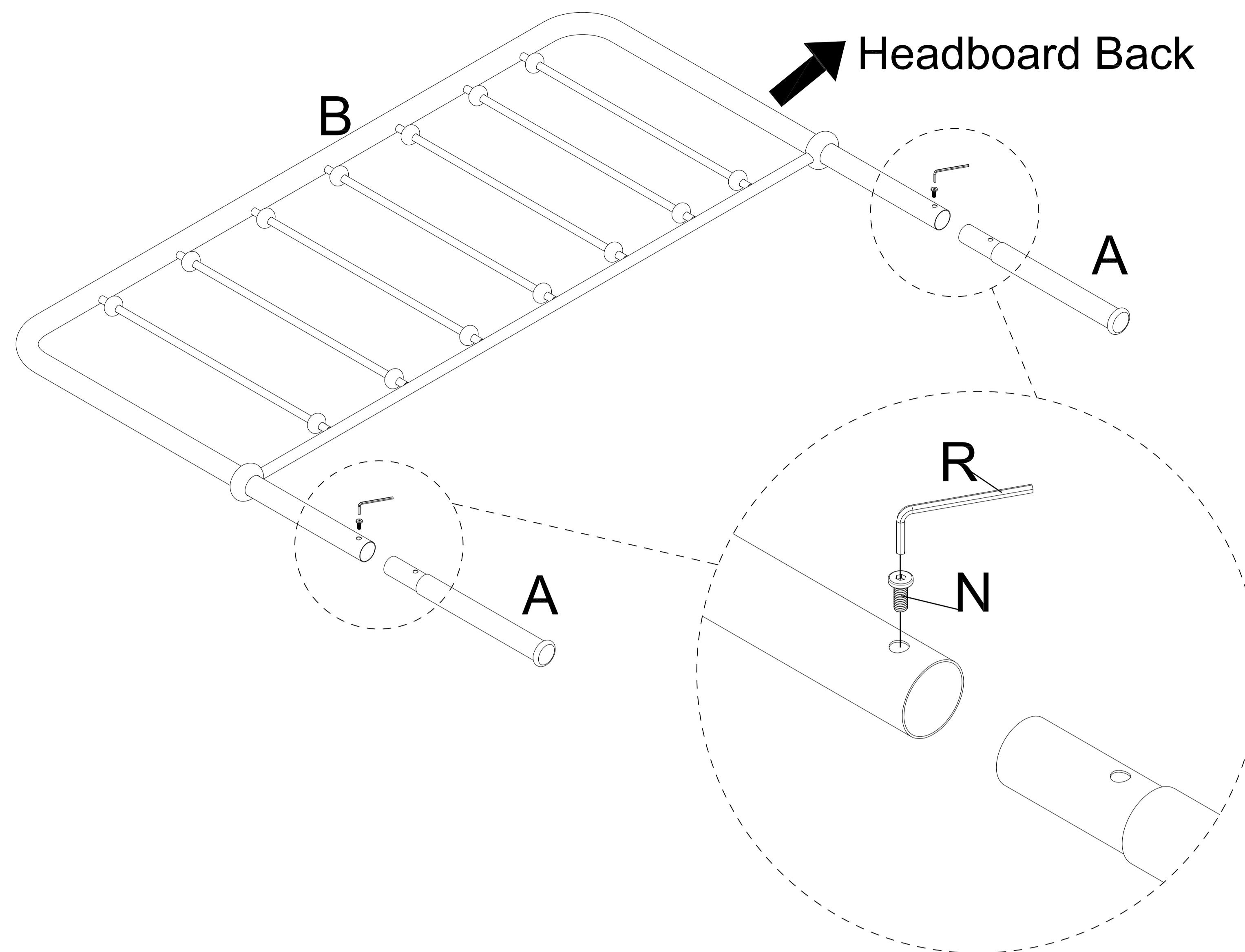
**2**

Attach the Rail Section (D), Rail Section (E) and Rail Support Leg (J), insert the Bolt (N), turn the L-Allen Key (R) to tighten them.

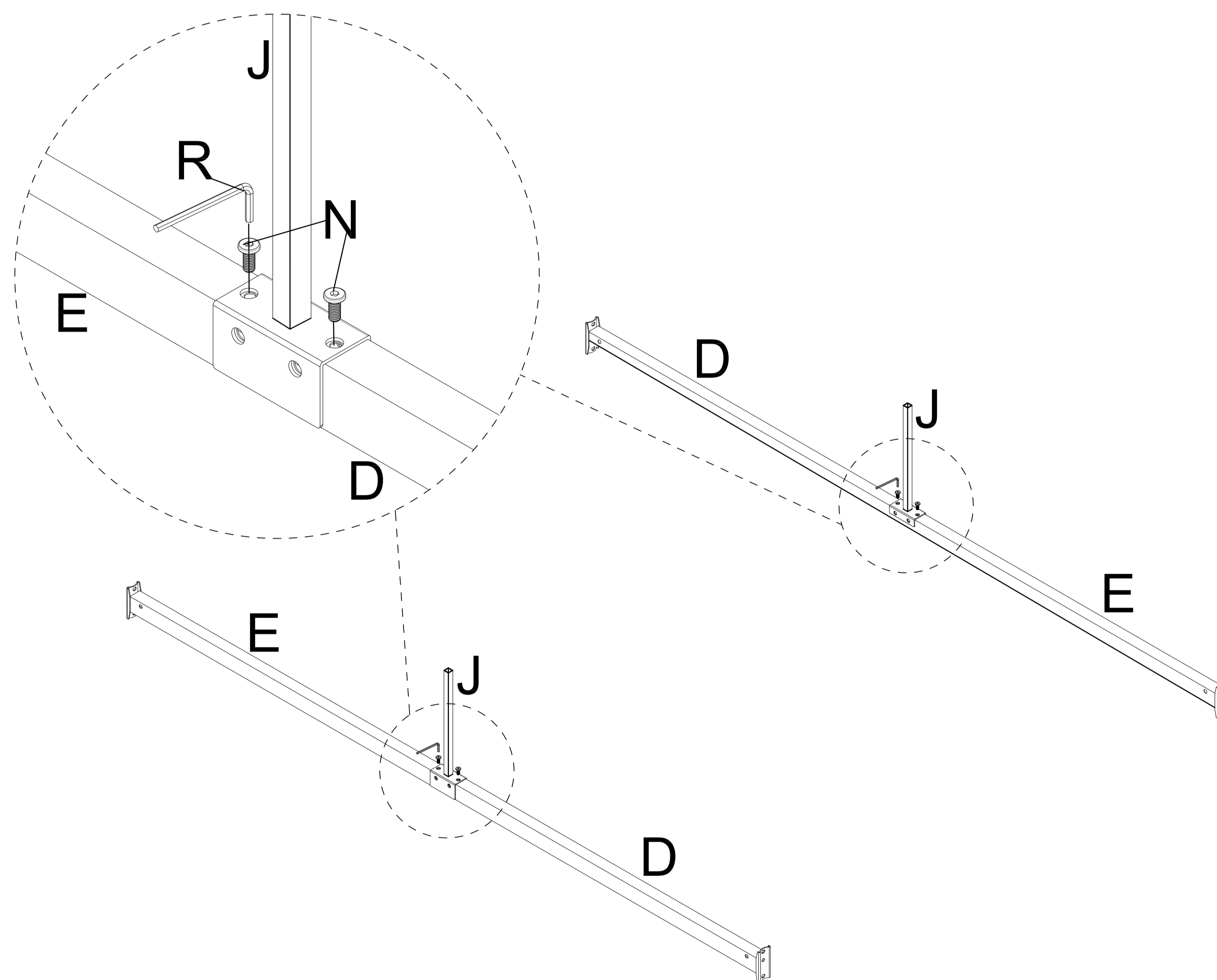
**3**

Attach the Center Support Bar (G) to rails, and then insert the Bolt (O) and Nut (Q), turn the L-Allen Key (R) and Wrench (S) to tighten them.

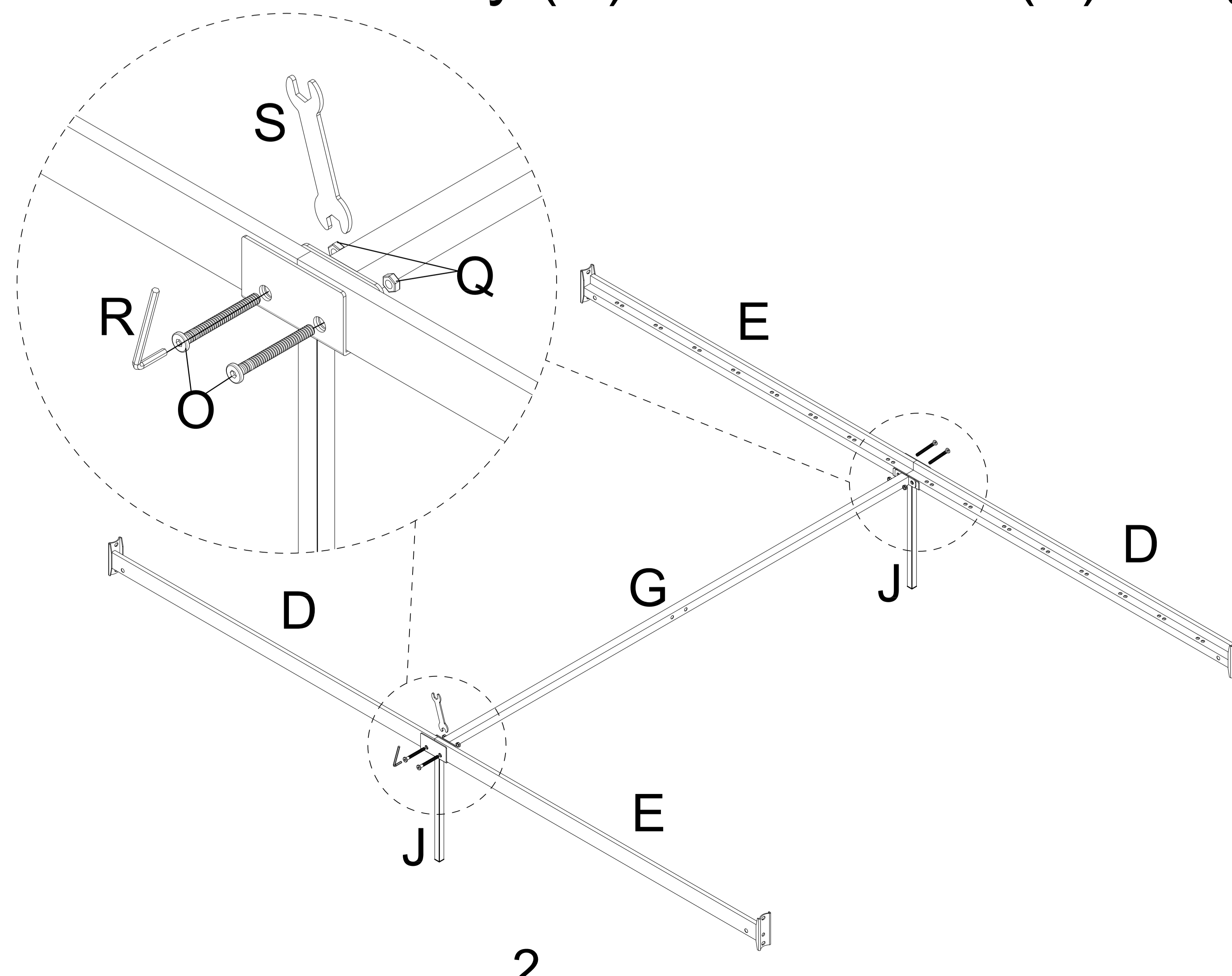

4

Attach the Front / Rear Support Bar (F) to rails, insert the Bolt (O), turn the L-Allen Key (R) to tighten them.

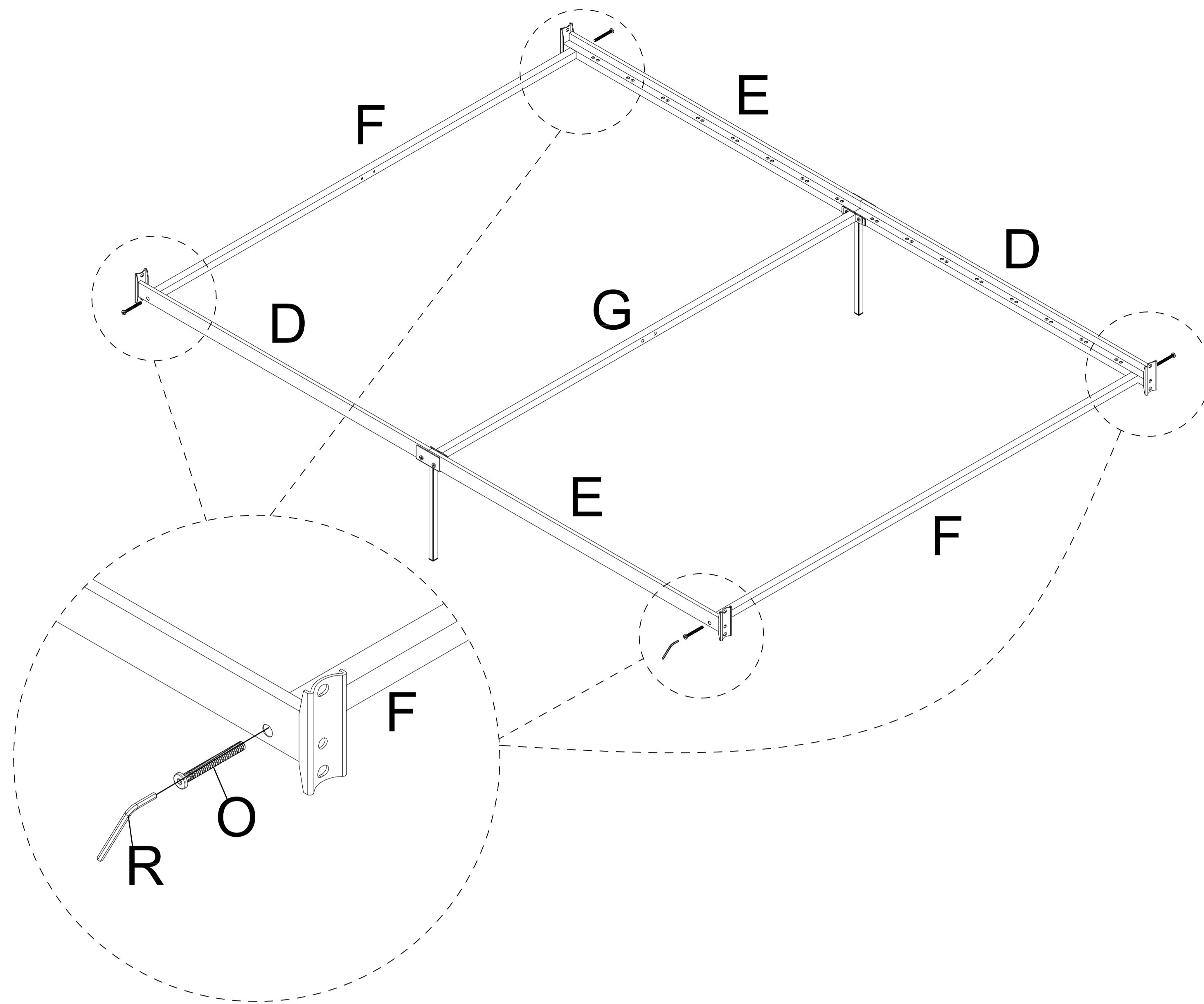
**5**

Attach the Front Center Rail (H) and Rear Center Rail (I) to the Front / Rear Support Bar (F) and Center Support Bar (G), insert the Bolt (N), turn the L-Allen Key (R) to tighten them. Insert the Bolt (P) and Nut (Q), turn the L-Allen Key (R) and Wrench (S) to tighten them.

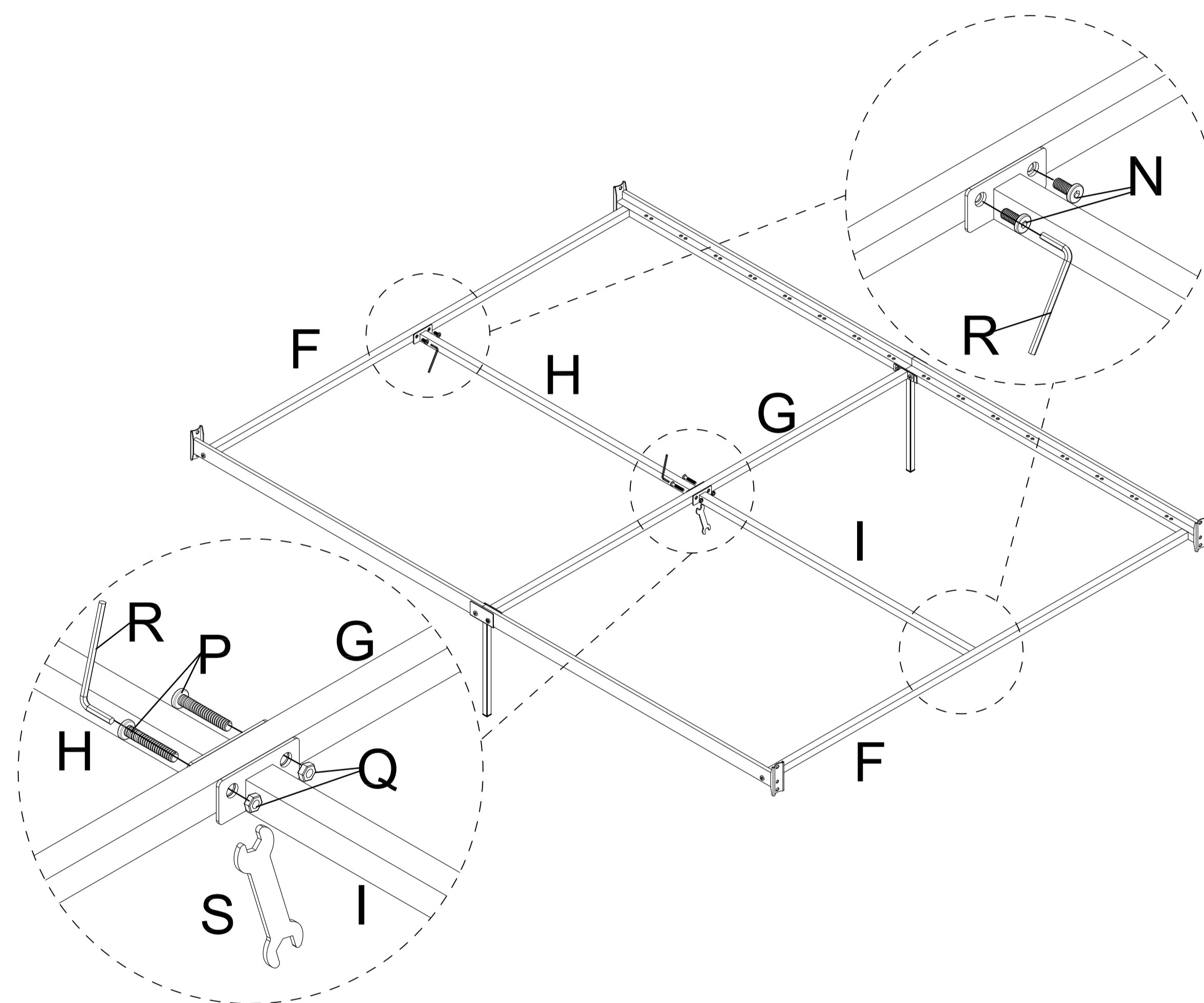
**6**

Attach the Center Support Leg (K) to the center rails, insert the Bolt (N), turn the L-Allen Key (R) to tighten them.

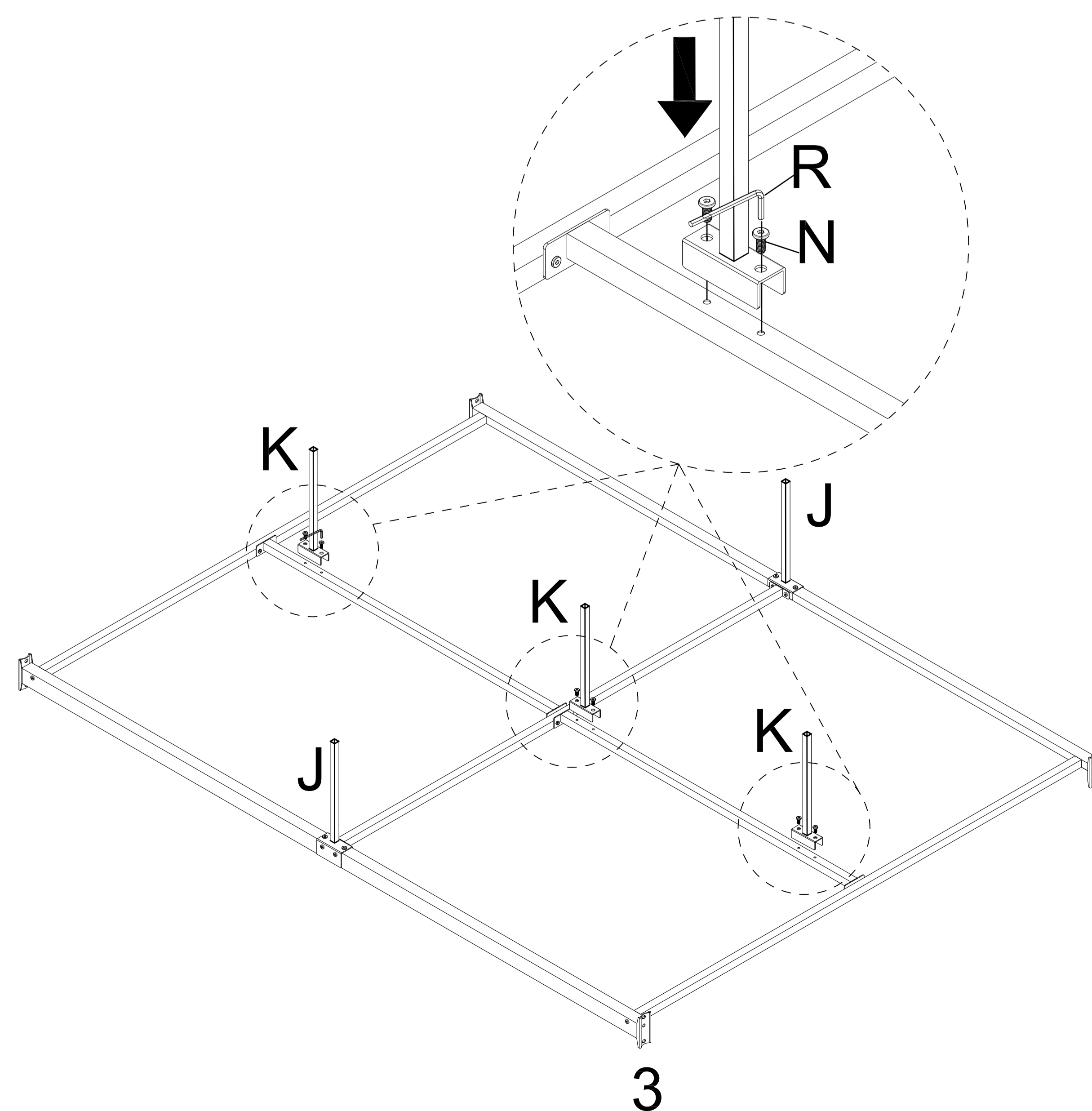

7

Attach the assembled metal frame to the Headboard Leg (A), Headboard (B) and Footboard (C), insert the Bolt (N), turn the L-Allen Key (R) to tighten them.

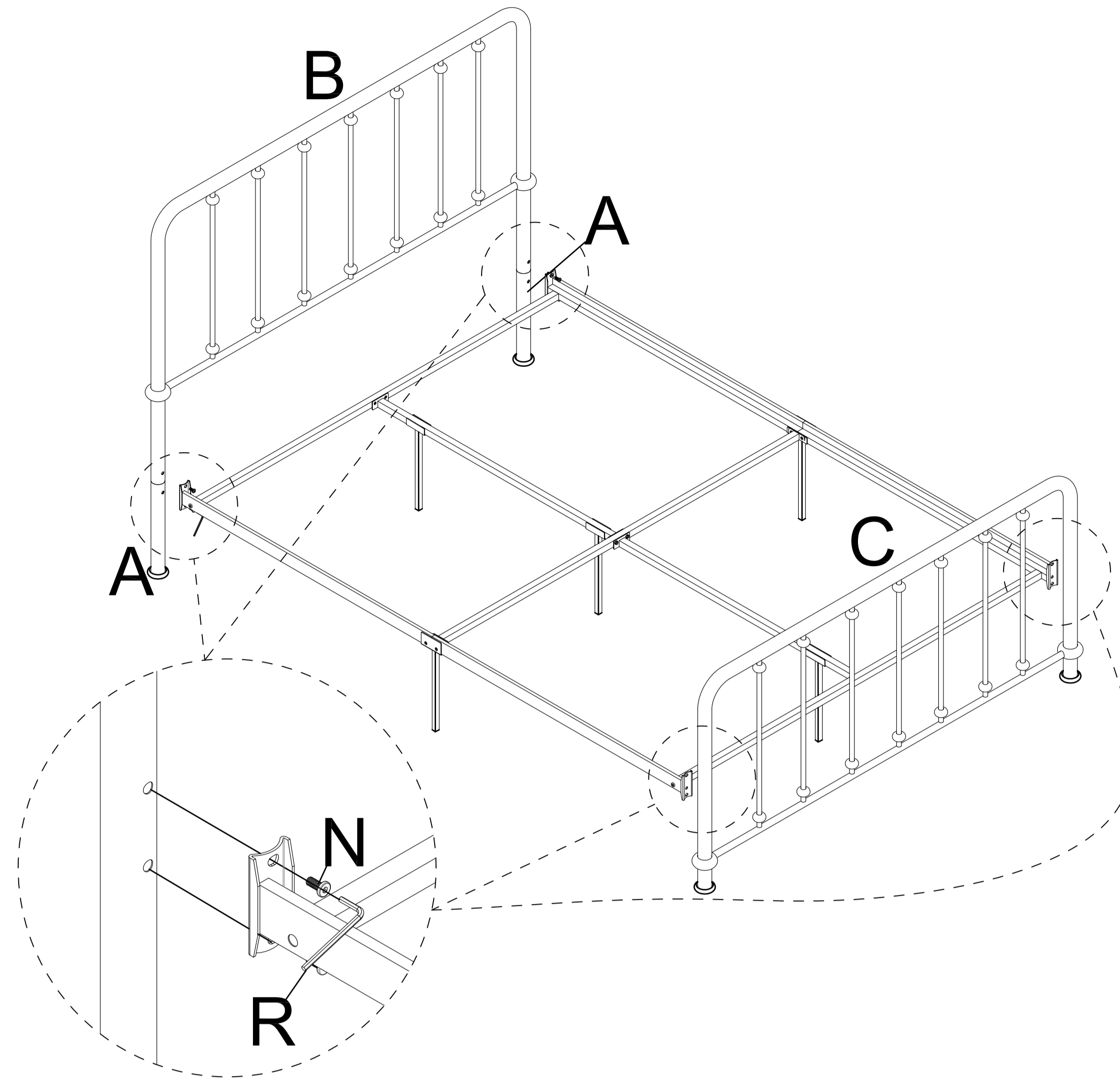
**8**

Insert the Slat Connector (M) to the both sides of Slat (L), press the Slat (L) into the correct place.

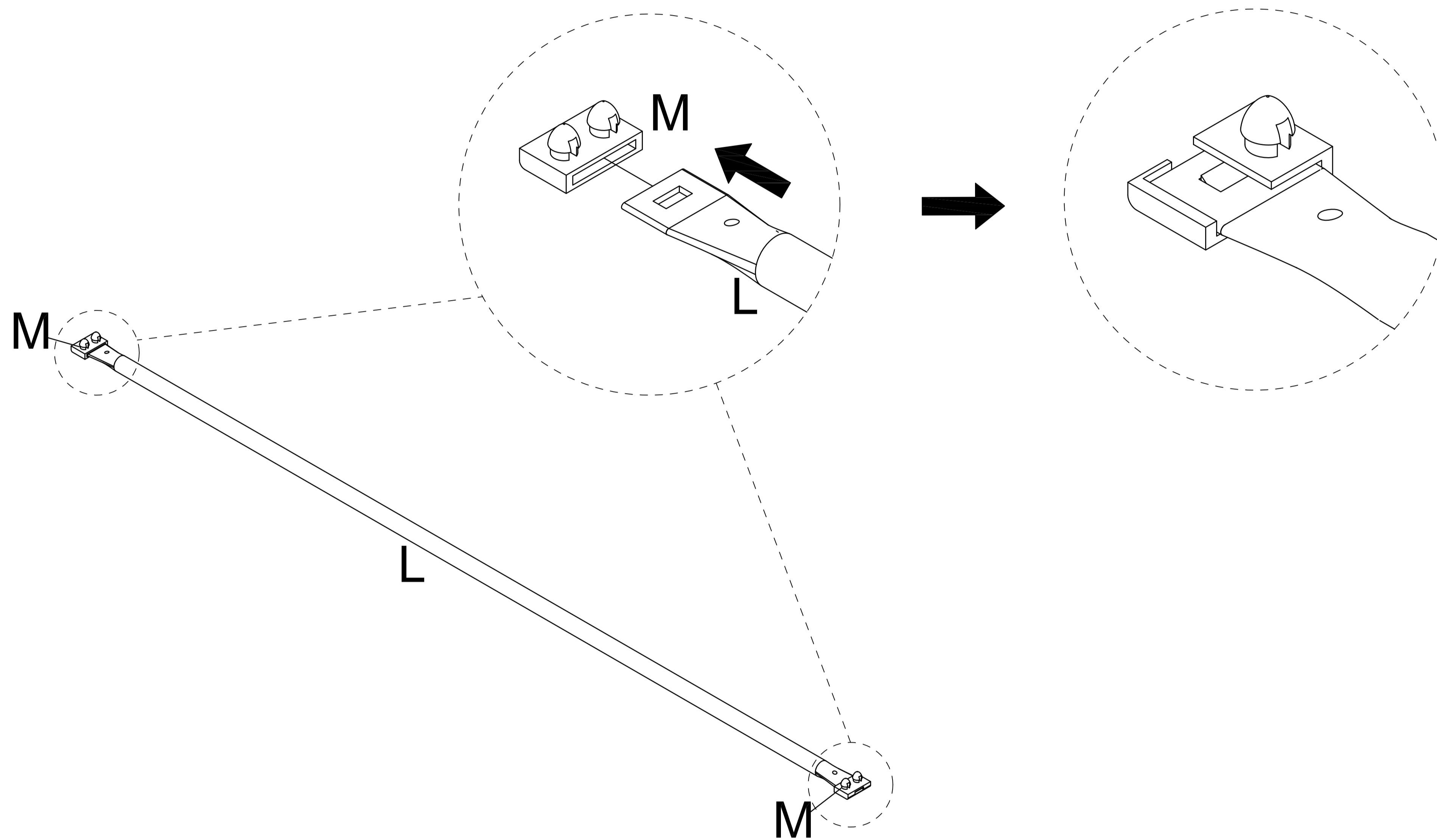
**9**

Attached the Slat (L) to rails, put the Slat Connectors (M) into the correct place and press them down.

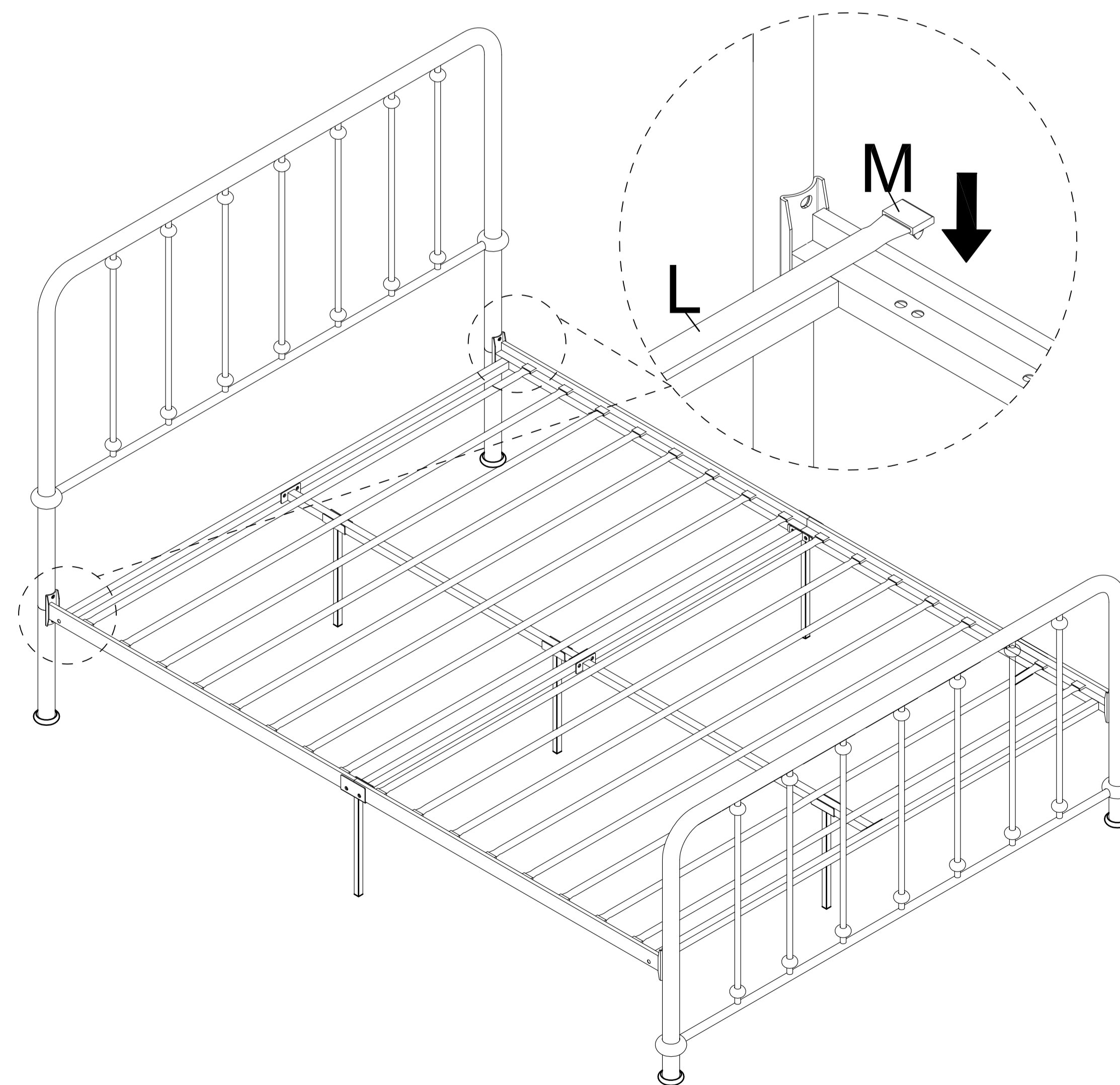

Cleaning & Care

Treat surface with care. Surface is resistant to scratches but is not scratch resistant. Clean surfaces with a dry or damp soft cloth. Do not use abrasive cleaners. Hardware may loosen over time. Periodically check that all connections are tight.