

# **ELURA**



---

## **COMMERCIAL**

**GREEN LABEL SERIES  
BLACK PENDANT MOUNT SPEAKERS  
OWNER'S MANUAL &  
INSTALLATION GUIDE**



**ELURA G6.5PEND-BK  
ELURA G8PEND-BK  
ELURA G8PENDSUB-BK  
70V/8Ω PENDANT MOUNT SPEAKERS**

	<b>CAUTION</b> RISK OF ELECTRIC SHOCK DO NOT OPEN	<b>ATTENTION</b> RISQUE DE CHOC ELECTRIQUE NE PAS OUVRIR	
<b>WARNING:</b>			
To reduce the risk of fire or electric shock, do not expose this apparatus to rain or moisture.			
<b>AVIS:</b>			
<b>Pour réduire le risque d'incendie ou de choc électrique, ne pas exposer cet appareil sous la pluie et l'humidité.</b>			
The apparatus shall not be exposed to dripping or splashing and that no objects filled with liquids, such as vases, shall be placed on apparatus.			
<i>L'appareil ne doit pas être exposé aux écoulements ou aux éclaboussures et aucun objet ne contenant de liquide, tel qu'un vase, ne doit être placé sur l'objet.</i>			



The lightning flash with arrowhead symbol, within an equilateral triangle, is intended to alert the user to the presence of uninsulated "dangerous voltage" within the product's enclosure that may be of sufficient magnitude to constitute a risk of electric shock to persons.

*Le symbole de l'éclair fléché dans un triangle équilatéral, est destiné à alerter l'utilisateur de la présence d'une "tension dangereuse" dans le boîtier du produit qui peuvent être des ampleur suffisante pour constituer un risque d'électrocution aux personnes.*



This symbol is intended to alert the user to the presence of important operation and maintenance (servicing) instructions in the literature accompanying the appliance.

*Ce symbole est destiné à alerter l'utilisateur de la présence d'opération et de maintenance (entretien) dans la documentation accompagnant l'appareil.*

## Important Safety Instructions

1. Read these Instructions.  
*Lisez ces instructions.*
2. Keep these Instructions.  
*Conservez ces instructions.*
3. Heed all Warnings.  
*Respectez tous les avertissements.*
4. Follow all instructions.  
*Suivez toutes les instructions.*
5. Do not use this apparatus near water.  
*Ne pas utiliser cet appareil près de l'eau.*
6. Clean only with a dry cloth.  
*Nettoyer uniquement avec un chiffon sec.*
7. Do not block any ventilation openings. Install in accordance with the manufacturer's instructions.  
*Ne pas bloquer les ouvertures de ventilation. Installer conformément aux instructions du fabricant.*
8. Do not install near any heat sources such as radiators, heat registers, stoves, or other apparatus (including amplifiers) that produce heat.  
*Ne pas installer près de sources de chaleur telles que radiateurs, registres de chaleur, poêles ou autres appareils (y compris les amplificateurs) produisant de la chaleur.*
9. Do not defeat the safety purpose of the polarized or grounding - type plug. polarized plug has two blades with one

wider than the other. When the provided plug does not fit into your outlet, consult an electrician for replacement of the obsolete outlet.

*Ne détruisez pas la sécurité de la terre ou polarisées - fiche. Une fiche polarisée possède deux lames dont une est plus large que l'autre. Si la fiche fournie ne rentre pas dans votre prise, consultez un électricien pour remplacer la prise obsolète.*

10. Protect the power cord from being walked on or pinched particularly at plugs, convenience receptacles, and the point where they exit from the apparatus.

*Protégez le cordon d'alimentation d'être piétiné ou pincé, particulièrement au niveau des fiches, des prises, et le point où ils sortent de l'appareil.*

11. Only use attachments/accessories specified by the manufacture .  
*N'utilisez que des accessoires spécifiés par le fabricant.*

12. Use only with a cart, stand, tripod, bracket, or table specified by the manufacturer, or sold with the apparatus. When a cart or rack is used, use caution when moving the cart/apparatus, combination to avoid injury from tip-over.



*Utilisez uniquement un chariot, stand, trépied, support ou table spécifiés par le fabricant ou vendu avec l'appareil. Quand un panier ou rack est utilisé, faites attention lorsque vous déplacez l'ensemble chariot / appareil, pour éviter d'éventuelles blessures en cas de chute.*

13. Unplug this apparatus during lightning storms or when unused for long periods of time.

*Débranchez cet appareil pendant les orages ou lorsqu'il n'est pas utilisé pendant de longues périodes de temps.*

14. Refer all servicing to qualified service personnel. Servicing is required when the apparatus has been damaged in any way, such as power-supply cord or plug is damaged, liquid has been spilled or objects have fallen into the apparatus, the apparatus has been exposed to rain or moisture, does not operate normally, or has been dropped.

*Confiez toute réparation à un personnel qualifié. Une réparation est nécessaire lorsque l'appareil a été endommagé de quelque façon que ce cordon d'alimentation ou la fiche est endommagé, liquide a été renversé ou des objets sont tombés dans l'appareil, l'appareil a été exposé à la pluie ou à l'humidité, ne fonctionne pas normalement, ou s'il est tombé.*

15. **WARNING:** The mains plug (appliance coupler) is used as disconnect device, the disconnect device shall remain readily operable.

***AVERTISSEMENT:** La fiche d'alimentation (appareil coupleur) est utilisé comme dispositif de déconnexion, le dispositif de déconnexion doit rester facilement accessible.*

16. No naked flame sources, such as lighted candles, should be placed on the apparatus.

*Aucune source de flamme nue, telle que des bougies allumées, ne doit être placé sur l'appareil*

17. Protective earthing terminal. The apparatus should be connected to a mains socket outlet with a protective earthing connection.



*Borne de terre de protection. L'appareil doit être connecté à une prise secteur avec une prise de terre.*

## Overview

The Elura line of pendant speakers offers two full-range 2-way products and one subwoofer suited for a wide variety of foreground and background applications such as restaurants, retail, concourses, transportation terminals, worship facilities, etc. All three products are designed to work with 8 Ohm or 70/100V amplifiers with a wide variety of transformer settings for the desired sound level requirement.

## Unpacking

Carefully remove your new Elura speaker from the box. Inspect the speaker for transit damage. If you discover damage, contact your dealer immediately. Save your carton - it is the best possible protection for your speaker should you ever have a need to move it.

## Contents

- 1 Elura loudspeaker
- 1 Gripple XP2-HG-15FT-1
  - Gripple lock
  - 15 ft cable and safety hook

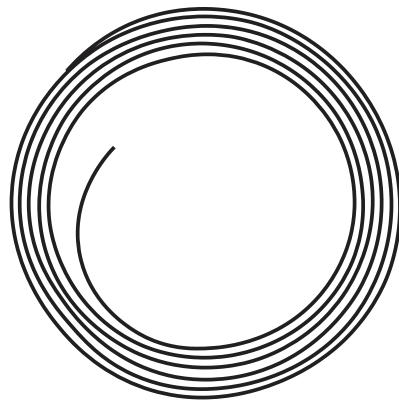

## Speaker Wiring

Typically, when connecting a 70/100V system, speaker wiring is run from the amplifier location to the first speaker location. The Elura Pendant speakers all come with a 4-Pin Phoenix connector that make it convenient to “loop” the connection from one speaker to another. In a typical 8 Ohm system, each speaker is directly connected to the amplifier (usually only one due to impedance and power demands).

Be sure to carefully examine your amplifier outputs for positive, 8 Ohm, 70V, 100V (+) and negative, ground, common (-) connections and the color code of your wire. Typically, speaker wire is color coded for Red (+) and Black (-), but your wire could be different. The critical thing here is to maintain the same polarity throughout your system for proper sound performance. Each Elura Pendant speaker has a 4-Pin Phoenix connector that allows easy looping (one speaker connected to another speaker). You can use either (+) and either (-) going in from the amplifier and then the other two pins to go out to the next speaker and so on.

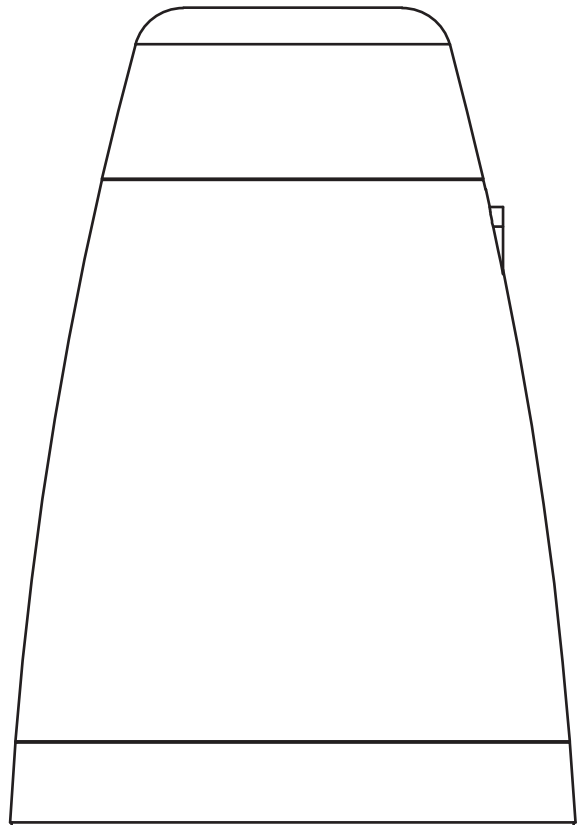
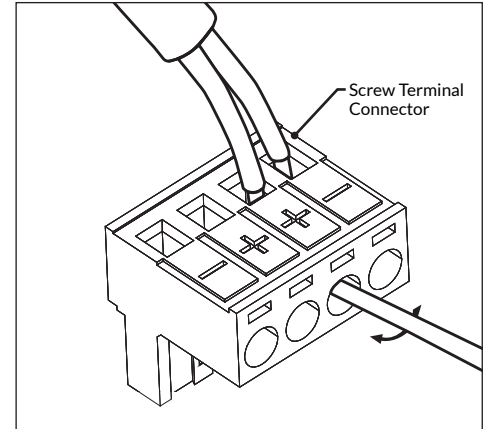
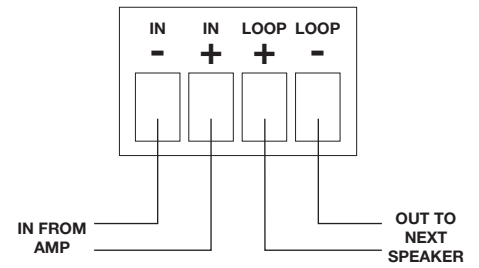

## Installation

Before you begin installation, please consult any local requirements in your area or consult the National Electrical Code, ANSI/NFPA 70 or the National Fire Alarm Codes for your area.

Once you have determined the location of each speaker in your room for the desired coverage, please refer to the steps on the right for proper hanging. For the full-range pendant speakers, we recommend avoiding corner placement and spreading the units evenly throughout the room for good sound coverage. For the subwoofer pendant speaker, typically locating it somewhere between the other full-range pendants usually works well. As a subwoofer, it can be greatly influenced by adjacent walls or corners that reinforce bass frequencies.

Before you hang the pendant speakers, you must remove the magnetically attached rear cover to access the hanging eyebolt, Phoenix connector and transformer switch. REMEMBER, the hanging cable and amplifier connecting wire must run through the back cover opening so it can be reattached once you are finished. If you are using a 70/100V amplifier, select the desired tap on the rear of the speaker for the sound level you desire before hanging it. Of course, you can always simply lift the magnetic cover to adjust the tap if you determine the sound level is too high or too low once you do your initial sound check.

## Caring for Your Speakers

All Elura enclosures can be cleaned with a damp soft cloth and a mild detergent. The aluminum grille can also be cleaned with the same cloth.

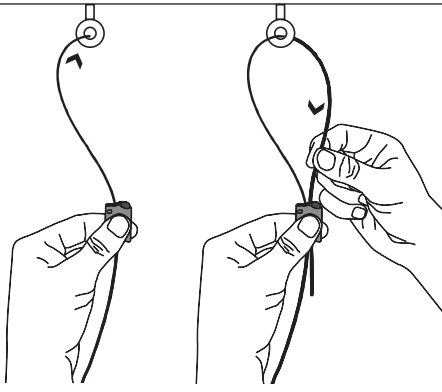
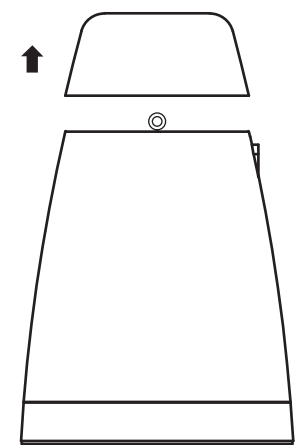
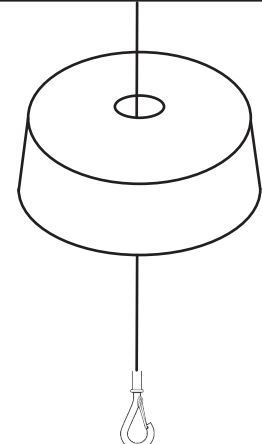
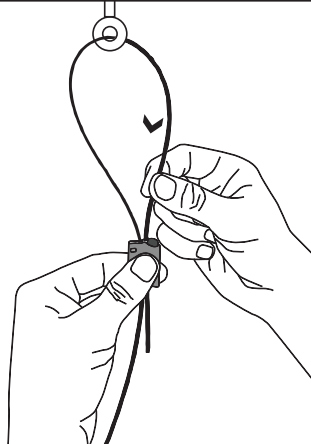
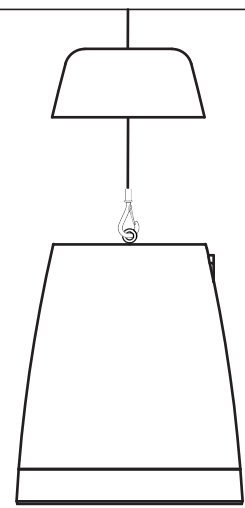
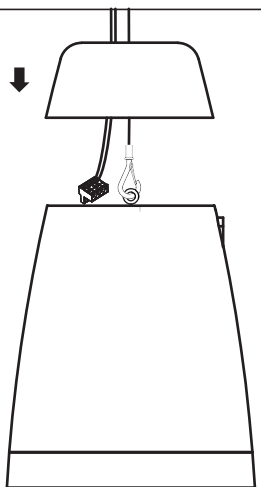
 <p>1. Pass the end of the cable through one hole of the gripper, then over the mounting structure, then through the other hole of the gripper.</p>	 <p>2. Lift the magnetic back cover off the speaker.</p>
 <p>3. Thread the cable that's attached to the mounting structure through the hole of the back cover and attach the safety hook.</p>	 <p>4. Press the button on the gripper and slide the cable through to the desired height to adjust speaker height.</p>
 <p>5. Connect the safety hook to the hole hanger attached to the speaker as shown.</p>	 <p>6. Plug the connected screw-terminal connector into jack on rear of speaker. Cut off any excess cable. Then close the magnetic back cover once done.</p>

## Specifications

	<b>G6.5PEND-BK</b>	<b>G8PEND-BK</b>	<b>G8PENDSUB-BK</b>
Description of the product	6.5" Coaxial, 2-way pendant loudspeaker	8" Coaxial, 2-way pendant loudspeaker	8" Pendant subwoofer
Cabinet/Enclosure material	Plastic injection	Plastic injection	Plastic injection
Tweeter size	0.75"	0.75"	/
Tweeter material	Black aluminium	Black aluminium	/
Tweeter magnet material	Neodymium	Neodymium	/
Tweeter Ferro-Fluid	Yes	Yes	/
Woofer size	6.5inch	8inch	8inch
Woofer cone material	Fiberglass	Fiberglass	Fiberglass
Woofer surround material	Rubber	Rubber	Rubber
Woofer voice-coil size	30.5mm	30.5mm	38.5mm
Woofer magnet weight	416.5g	601.3g	565.4g
Frequency response	60Hz-20KHz ± 3db	45Hz-20KHz ± 3db	45Hz - 500Hz ± 3db
Recommended amplifier power	80 watts RMS	120 Watts RMS	150 watts RMS
Sensitivity level	89db @ 1W at 1 meter	91db @ 1W at 1meter	89db@ 1W at 1 meter
Input terminals	4 pin phoenix	4 pin phoenix	4 pin phoenix
Transformer taps & thru setting	5W/10W/15W/20W 70V taps & 8Ω bypass	5W/10W/20W/30W 70V taps & 8Ω bypass	15W/30W/45W/60W 70V taps & 8Ω bypass
Speaker dispersion angle (-6dB)	130° Conical (500Hz-5kHz average)	110° Conical (500Hz-5kHz average)	Omni (45Hz-500Hz)
Grille	Push-On Aluminium	Push-On Aluminium	Push-On Aluminium
Mounting style	Pendant	Pendant	Pendant
Dimensions	9" x 13.15"	10.63" x 15.25"	10.63" x 15.25"
Net weight	8.4 lb (3.8 kg)	12.3 lb (5.6 kg)	12.3 lb (5.6 kg)
Gross weight	11.6 lb (5.25 kg)	17.3 lb (7.85 kg)	17.3 lb (7.85 kg)

## Troubleshooting

If you should have a problem, first try to determine if it is indeed a speaker problem. Determine whether the problem exists in one or all speakers. If it is all speakers, the problem most likely originates in some other components in the system. If the problem is in one speaker only, try connecting it to another amplifier to see if it works correctly. If you have tried all the above and still can't get the Elura speaker to operate properly, consult your dealer or contact MSTR Brand.

## Product Warranty

The seller warrants the G6.5PEND-BK, G8PEND-BK, and G8PENDSUB-BK free from defects in the material and workmanship for 5 years from the date of purchase from the seller or authorized dealer. Should this product fail to be in good working

order within the warranty period, the seller, at its option repair or replace the unit, provided that the unit has not been subjected to accident, disaster, abuse, or any unauthorized modification. This warranty is offered by the seller for its buyer with direct transaction only. This warranty does not apply to products that have been abused, incorrectly installed, modified, disassembled and/or repaired by anyone other than Elura or our appointed repair facility. A unit that fails under conditions other than those covered will be repaired at the current price of parts and labor in effect at the time of repair. Such repairs are warranted for 90 days from the day of reshipment to the buyer. If the unit is delivered by mail, customers agree to insure the unit or assume the risk of loss or damage in transit. Under no circumstances will a unit be accepted without a return authorization number.

The warranty is in lieu of all other warranties expressed or implied, including without limitations, any other implied warranty, all of which are expressly disclaimed. Proof of sale may be required in order to claim warranty.

The content of this manual has been carefully checked and is believed to be accurate. However, the seller assumes no responsibility for any inaccuracies that may be contained in this manual. Also, the technical information contained herein regarding the G6.5PEND-BK, G8PEND-BK, and G8PENDSUB-BK features and specifications are subject to change without further notice.

[www.elura.com](http://www.elura.com)

**MSTR**