

ASSEMBLY INSTRUCTION

29" SWIVEL BAR HEIGHT STOOL

A Acrylic Seat

(In Other Carton)

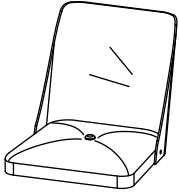

1pc

B Side Panel

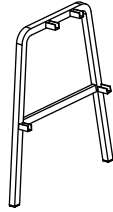

2pcs

C Top Stretcher

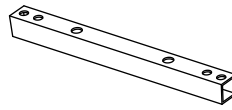

2pcs

D Bottom Stretcher

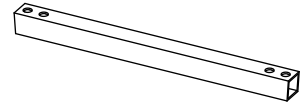

2pcs

E Swivel

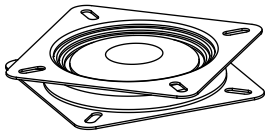

1pc

F Bolt

1/4"x 1/2"

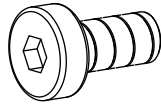

20pcs

G Bolt

1/4"x3/4"

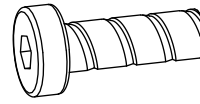

4pcs

H Lock Washer

5/16"



4pcs

I Shaft Sleeves

1/4"x25mm

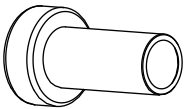

4pcs

J Flat Washer

1/4"

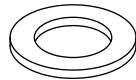

4pcs

K Allen Wrench

1/4"

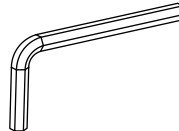

2pcs

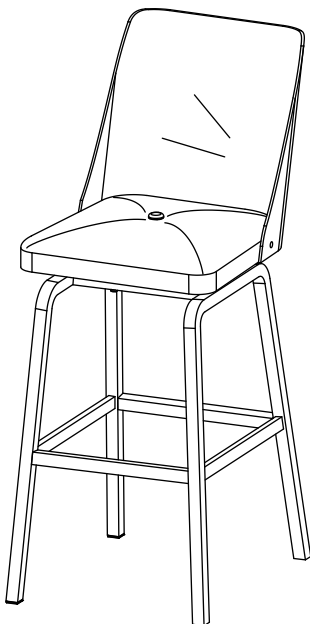

This page lists all the contents included in the box. Please take the time to identify the hardware as well as the individual components to this product. As you unpack and prepare for assembly, place the contents on a carpeted or padded area to protect them from damage.

1

Attach top stretcher (C) and bottom stretcher (D) to side panel (B) by using bolts (F) and allen wrench (K) as shown.

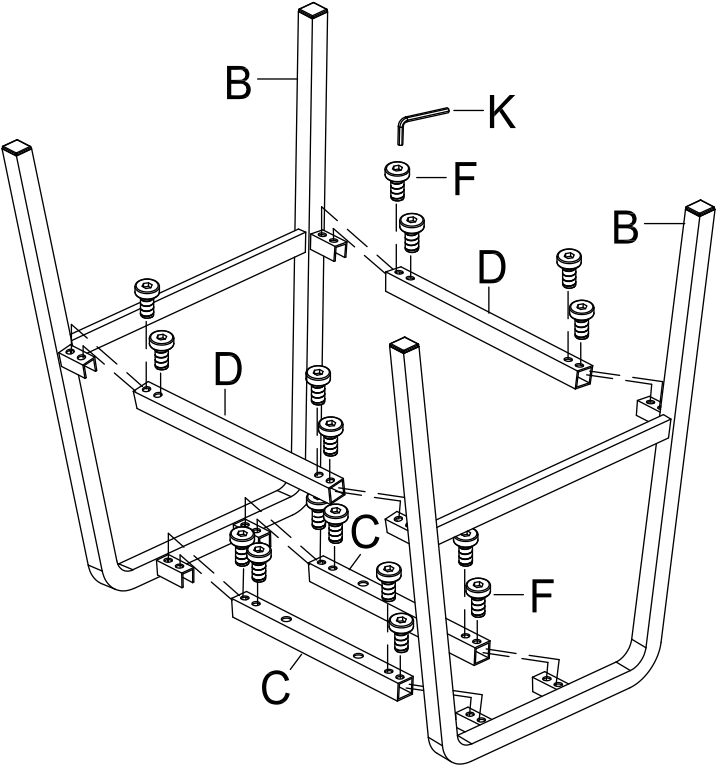

2

Attach swivel (E) to the assembled unit by using bolts (F), lock washers (H), shaft sleeves (I) and allen wrench (K) as shown.

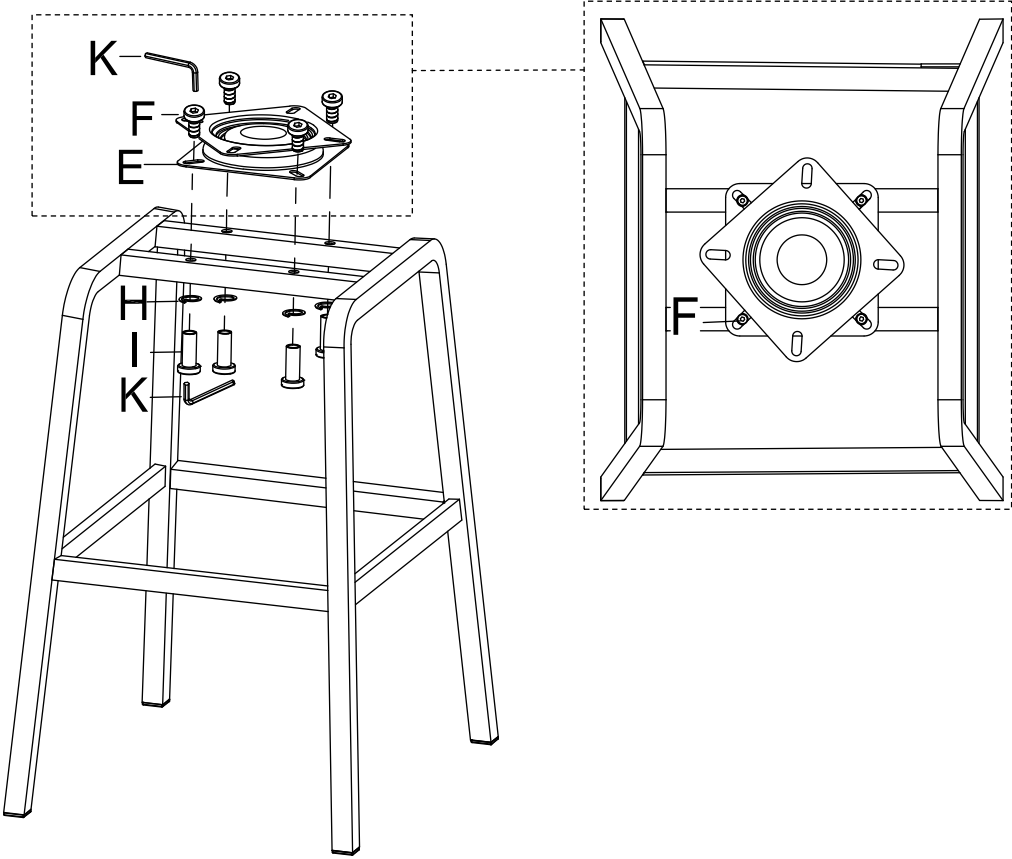

3

Put the acrylic seat (A) on the table and attach the assembled unit to it by using bolts (G), flat washers (J) and allen wrench (K) as shown.

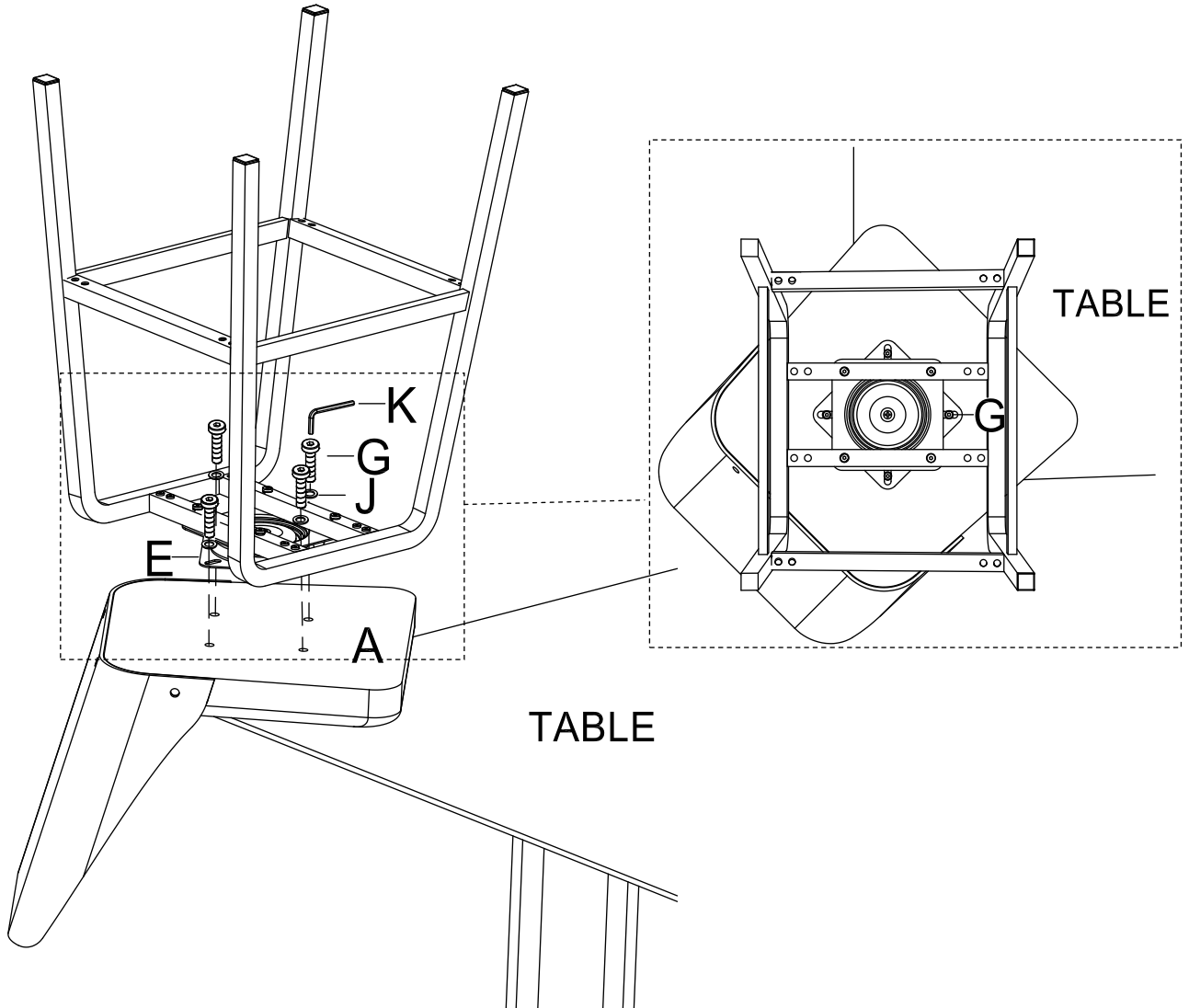

Cleaning & Care

Treat surface with care. Surface is resistant to scratches but is not scratch resistant. Clean surfaces with a dry or damp soft cloth. Do not use abrasive cleaners. Hardware may loosen over time. Periodically check that all connections are tight.