

NOTES:

1 OPEN DOOR VIEW INCLUDES HINGE SPACE OFFSET.

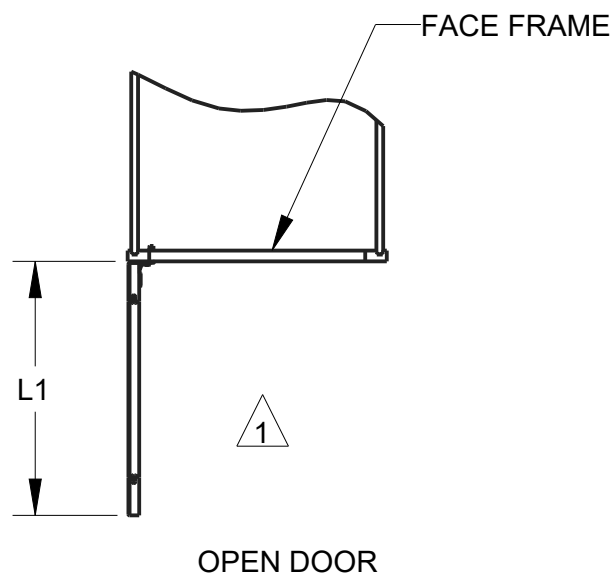
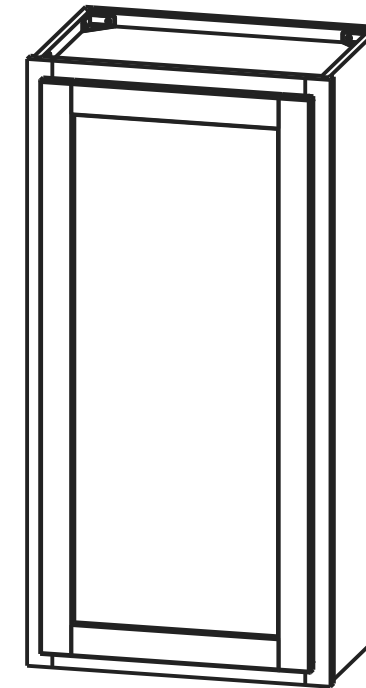
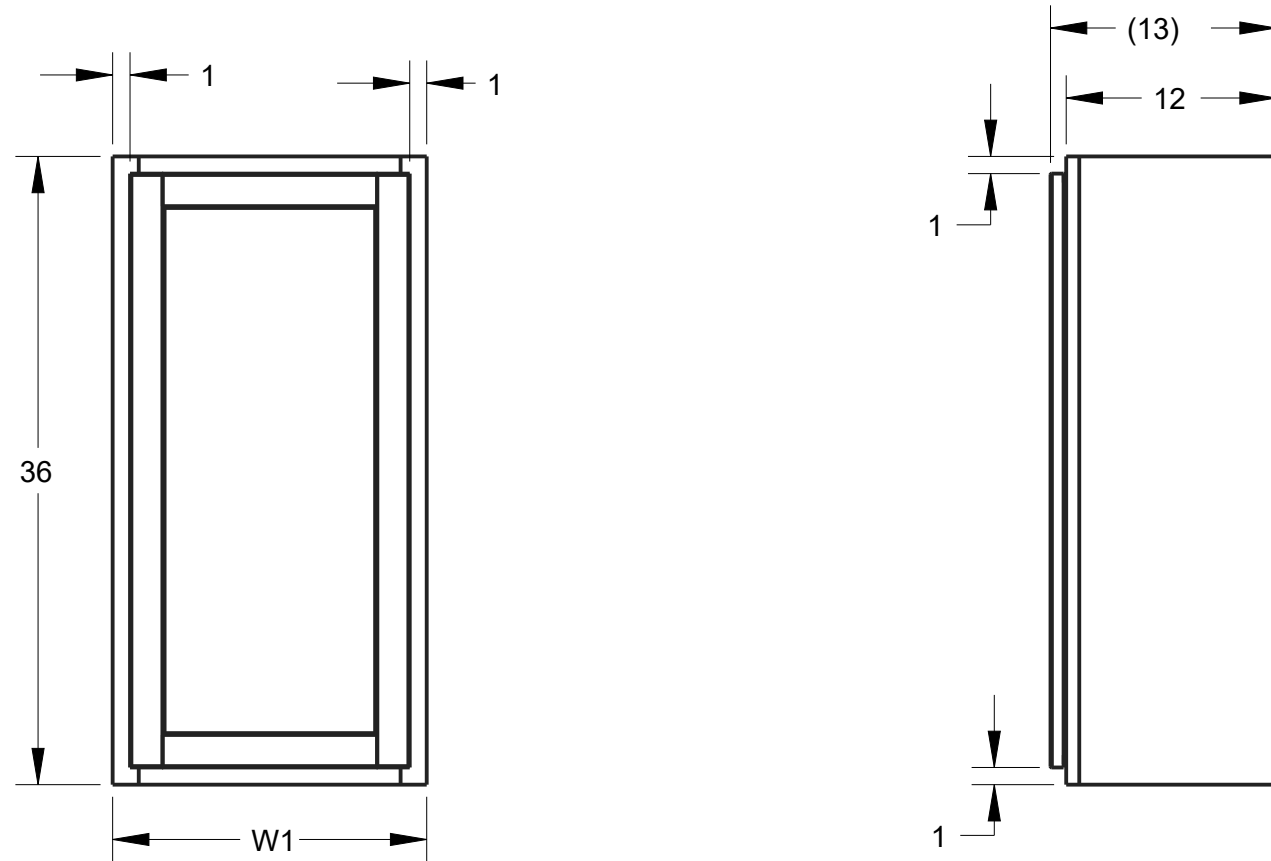

OPEN DOOR

PRODUCT SHOWN W1836

DOCUMENT STATUS Released

THIRD ANGLE PROJECTION

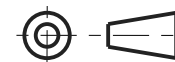

MATERIAL

FINISH

N/A

N/A

DRAWN BY
ANDY BROWN

DATE
25FEB2021

DESIGNED BY
NORTHPOINT

DATE

APPROVED BY
E.GOLESTANYAN

DATE
11MAR2021



DESCRIPTION

W0936, W1236, W1536, W1836, W2136
HALF OVERLAY

DRAWING NUMBER
W0936-W1236W1536W1836W2136_HALF

REV
B

SIZE
A3

SCALE
0.100

SHEET
1 / 1

HARDWARE RESOURCES RESERVES THE RIGHT TO CHANGE SPECIFICATIONS WITHOUT NOTICE.
IN CASE OF A DISCREPANCY, ACTUAL PART GEOMETRY SUPERSEDES THIS DOCUMENT.

THE INFORMATION CONTAINED WITHIN THIS DRAWING IS THE SOLE PROPERTY OF HARDWARE RESOURCES INC. ANY
REPRODUCTION IN PART OR WHOLE WITHOUT WRITTEN PERMISSION OF HARDWARE RESOURCES INC. IS PROHIBITED.