

ASSEMBLY AND INSTALLATION INSTRUCTIONS

W0390

WARNING: TO AVOID RISK OF ELECTRICAL SHOCK, BE SURE TO SHUT OFF POWER WHILE INSTALLING OR SERVICING THIS FIXTURE.

NOTE: 1. Before installing, consult local electrical codes for wiring and grounding requirements.
2. READ AND SAVE THESE INSTRUCTIONS.

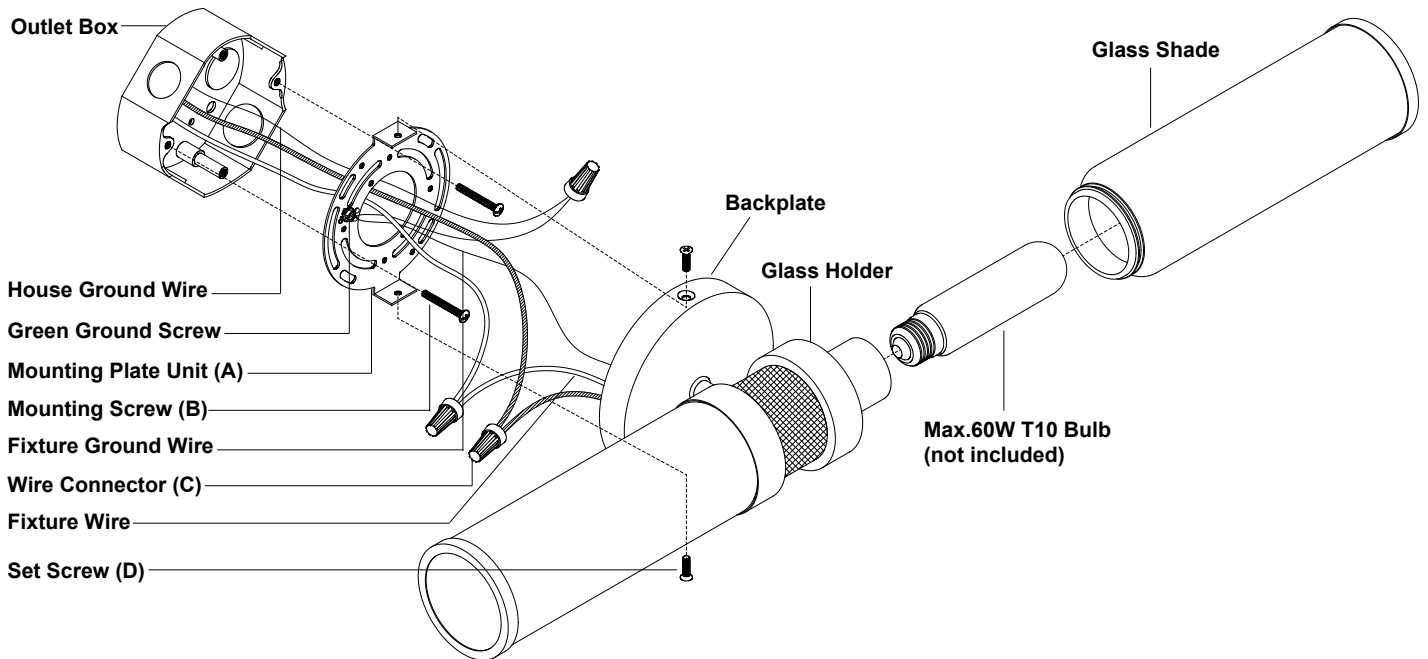
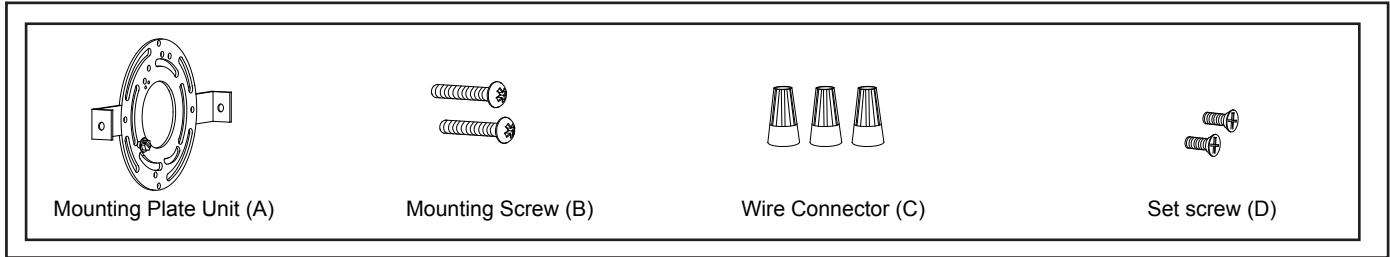

Installation Steps

Turn off the power at fuse or circuit box

1. Remove the mounting plate unit (A) from the backplate by disassembling the set screws (D).
2. Attach the mounting plate unit (A) to the outlet box by using two mounting screws (B).
Note: Make sure that two set holes are lined up horizontally to make the fixture level.
3. Pull out the source wires from the outlet box. Make wire connections using wire connectors (C) as follows:
 - Connect the hot wire (black insulation) from the fixture to the black wire from the power source.
 - Connect the neutral wire (white insulation) from the fixture to the white wire from the power source.
 - Attach the fixture ground wire (bare wire) to the mounting plate unit (A) with the green ground screw, then depending on local code, connect it to the house ground wire with the wire connector (C).Carefully put all of the wires back into the outlet box.

4. Attach the backplate of the fixture to the mounting plate unit (A) by aligning holes, secure the two set screws (D) from the side hole of the backplate into the hole of the mounting plate unit (A).
5. Install the bulbs (not included). Check relamping label at socket area or packaging for maximum wattage allowed.
6. Rotate the glass shades onto the glass holders.

Turn on the power at fuse or circuit box

The following parts are available for re-order if damaged or missing.

Spare Parts List:

Mounting Plate Unit (A) Mounting Screw (B) Wire Connector (C) Set screw (D)

Mounting Hardware 6348MM (1SET)

Glass Shade 1024CG

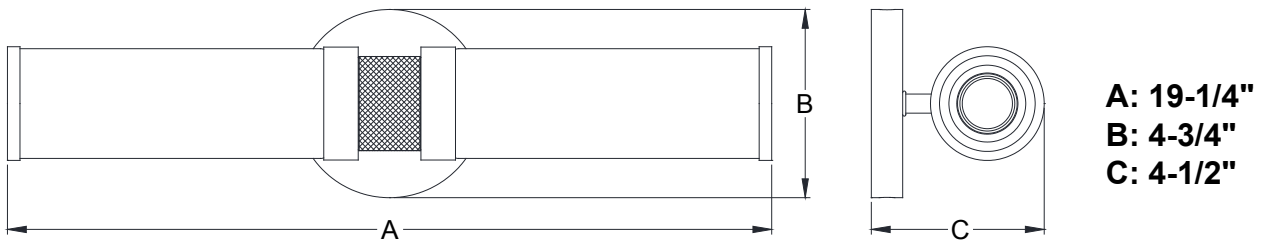

1 Year Warranty

Vaxcel warrants all of our products against defects in workmanship and finishes for one year following the date of shipment.

Exclusions: This warranty does not include the failure of products from extreme acts of nature; environmental conditions not suited for the products intended use; operation in temperatures outside of the range specified in the instruction manual; usage with improper power supply, power surges or dips. For coastal locations, some corrosion is considered normal for the environment.

Vaxcel reserves the right to repair, replace or issue a credit for any properly installed product, provided it is returned per RMA instruction. This warranty is limited to the cost of the product only and does not extend to transportation, installation or replacement costs.

How can warranty service be obtained?

info@vaxcel.com
 1-800-482-9235