

FRONT

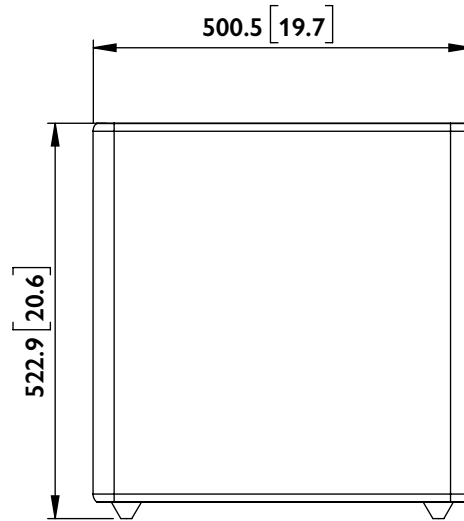

SIDE

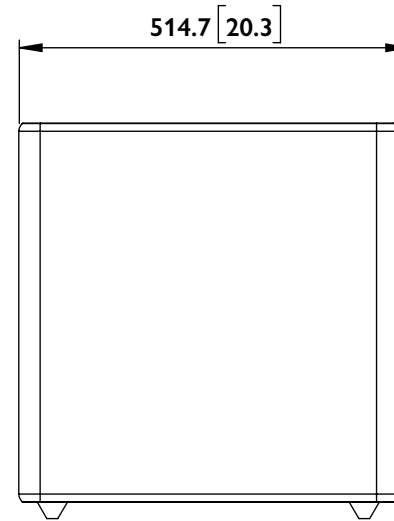

BACK

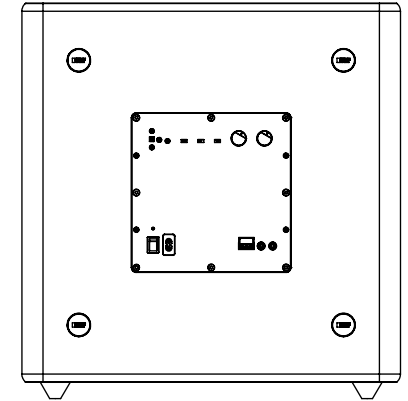

BOTTOM

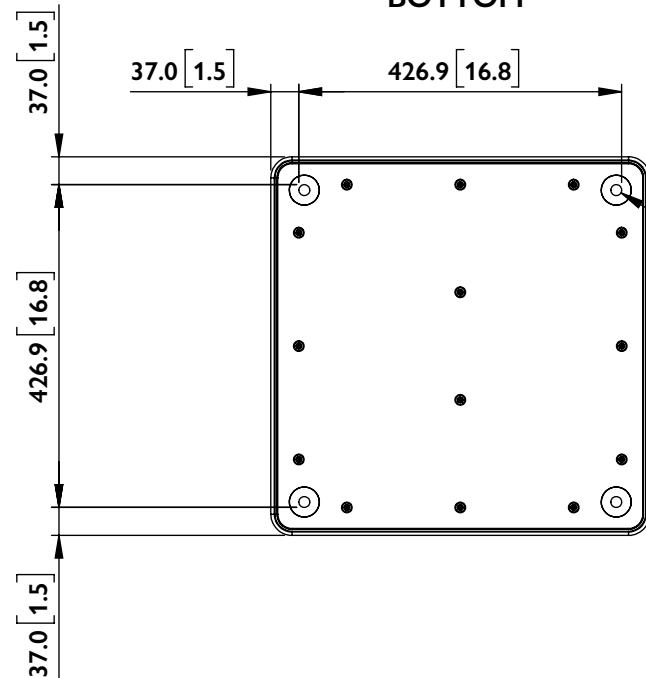

Feet thread size:
M6 x pitch 1.0

Kube 15 MIE

UNIT: MM [INCH]