



BE880B USER MANUAL

**BLUETOOTH® | 340 WATTS | SINGLE-DIN
DVD/MP3/CD AM/FM RECEIVER**

FEATURING 7" (178 mm) WIDESCREEN MOTORIZED TOUCHSCREEN
DIGITAL TFT LCD MONITOR AND MULTICOLOR ILLUMINATION



Congratulations on your purchase of a **Boss Audio Systems Elite**®

Multimedia Receiver.

It has been designed, engineered and manufactured to bring you the highest level of performance and quality, and will offer you years of entertainment pleasure.

Specifications.....	1
Safety Notice.....	2
Accessories.....	3
Unit Installation.....	3
Wire Connection Description.....	4
Panel Introduction.....	5
Remote Control Introduction.....	6
Main Menu Operation Instruction.....	7
Access Setup Interface.....	8
General Settings.....	7
Camera Settings.....	8
Clock Settings.....	8
Audio Settings.....	8
Controls Color Settings.....	9
Tuner Settings.....	9
Illumination Settings.....	9
About Settings.....	10
Tuner Operation.....	10
DISC/CD/USB Playback.....	11
DVD/VCD Mode Operation.....	11
Media Playing - CD Audio.....	12
CD Source Menu	12
USB Music/Video/Picture Operation.....	12-13
Bluetooth Operation.....	14
Bluetooth Operation Menu.....	14
Bluetooth Dialing.....	14
Bluetooth Call.....	14
Bluetooth Phone Book.....	15
Bluetooth Phone Call History.....	15
Bluetooth Paired Device.....	15
Bluetooth Music Streaming.....	15
A-LINK(Screen Mirroring) Operation.....	16
PTT(Push-To-Talk) Operation.....	16
Steering Wheel Control (SWC).....	17
Troubleshooting.....	18

SPECIFICATIONS

Model No.	BE880B		
General features	7" motorized TFT touchscreen Detachable front panel FM/AM Radio RBDS DVD fully compatible with DVD/VCD/CD/MP3/MPEG4/JPEG A-Link (Screen Mirroring) Dual USB (front / rear) support USB Charging (1A) Bluetooth audio stream and hands-free phone call Push-To-Talk (PTT) AUX input AV input Video output Front/Rear view camera support 4V Front and subwoofer pre-amp outputs Max. 4 x 85W power output Steering wheel control (SWC) input		
TFT screen	800 x 480 pixel		
Front/Rear USB	64G		
Working power	12V		
Max Output	4 x 85W		
Working Temperature	-20°C ~ 70°C/-4°F ~ 158°F		
Size	7.01" x 6.57" x 1.97" / 178 x 167 x 50 mm		
Weight	4.19 lbs / 1.90 kg		
Compatible Media			
Picture	JPG/JPEG/BMP		
Disc	CD/CD-R/CD-RW/DVD/DVD±R/DVD±RW		
Audio file	MP3/WAV/WMA/FLAC		
Video file	Format	Video code	Audio code
	.MPEG1	MPEG1	MP2
	.MPG	MPEG2	MP2

SAFTY NOTICE

Please read and understand the following safety information before operating this unit.

WARNING!

To ensure safety while driving and to comply with laws, drivers should not watch video or operate the video device while driving.

- ⊘ The unit is suitable for 12V power supply (requires grounding). Do not connect it to 24V power supply in trucks or buses, or else it will be damaged.
- ❗ Do not replace the fuse without the guidance of qualified personnel or the unit may be damaged and/or catch fire.
- ⚠ Please follow the traffic laws and regulations and do not watch programs or operate the unit when you are driving to avoid accidents (excluding passengers watching through rear monitor).
- ❗ To ensure safety and normal unit operation, please ask qualified personnel to install the unit. Do not disassemble or repair the unit without authorization. To avoid damage and accidents, please contact a local car audio distributor for details.
- ⊘ Do not put the unit in a moist environment or water to avoid electric shock, damage, and/or fire due to a short circuit.
- ⊘ The mechanical drive part of the monitor uses an automatic precision transmission component. Do not pull, push or rotate the unit by force or impact the TFT screen to avoid damaging the unit.
- ❗ Do not insert the audio plug of the vehicle into the master unit directly. Please convert with the dedicated end cable provided by our company.
- ❗ When installing the unit, prevent metal objects from falling into the master unit from the vents to avoid a short circuit and damaging the unit.

Safety Statement

- ⊘ For the safety of yourself and others, do not watch programs or operate the unit when you are driving. It is prohibited by law.
- ❗ The back up camera function should be used as an auxiliary view only. We are not responsible for any accidents occurred during backing.

Notes for Battery

- ❗ Replace only with the same type battery (CR2025). Observe correct polarity while inserting the battery.
- ❗ Remove the battery from the remote control if not used for a long time.
- ⊘ The remote control contains a coin/button type battery, which can be swallowed. Keep the battery out of reach of children at all times!
- ⚠ Batteries contain chemical substances, so they should be disposed of properly.

ACCESSORIES/INSTALLATION

ACCESSORIES

- 1x Remote control
- 1x Wire harness
- Head unit mounting kit
- 1x Mounting sleeve
- 1x Mounting strap
- 1x Tapping screw
- 1x Plain washer
- 1x Spring washer
- 1x Hex bolt
- 1x Hex nut
- 2x Release keys

INSTALLATION

Before you start

- Make sure your dash opening has the correct size shown.
- Disconnect the negative battery terminal of your vehicle.
- Complete the electrical connections.

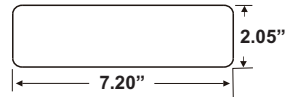

Mount the unit

1. Remove the plastic trim ring. Use a screwdriver to pry open the trim ring then pull it out.
2. Remove the mounting sleeve from the unit. Insert two supplied release keys into the lock position on both sides of the mounting sleeve, then pull the sleeve out of the unit.
3. Correctly insert the mounting sleeve in the dash opening. Then bend the tabs on the mounting sleeve with a screwdriver to secure the mounting sleeve.
4. Insert the unit into the dash opening/mounting sleeve.
5. Use the supplied mounting strap to secure the rear part of the unit.
6. Connect all wirings to the head unit. Replace the plastic trim ring.

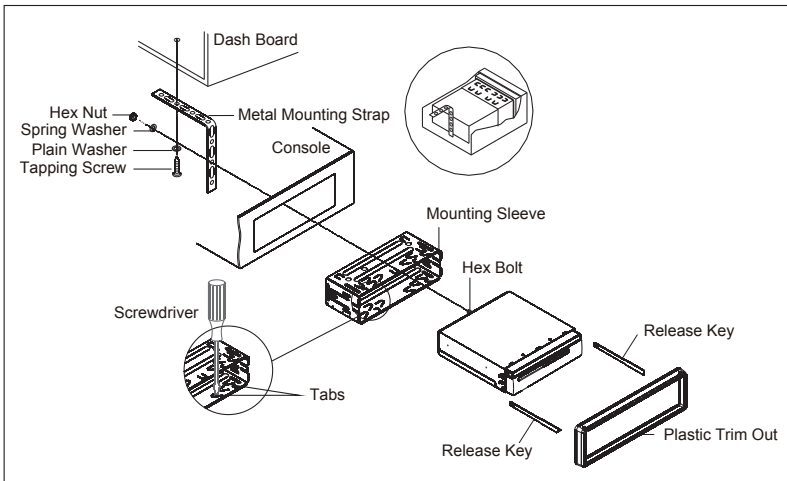

WIRE CONNECTION DESCRIPTION

Description of the Input/Output Interface

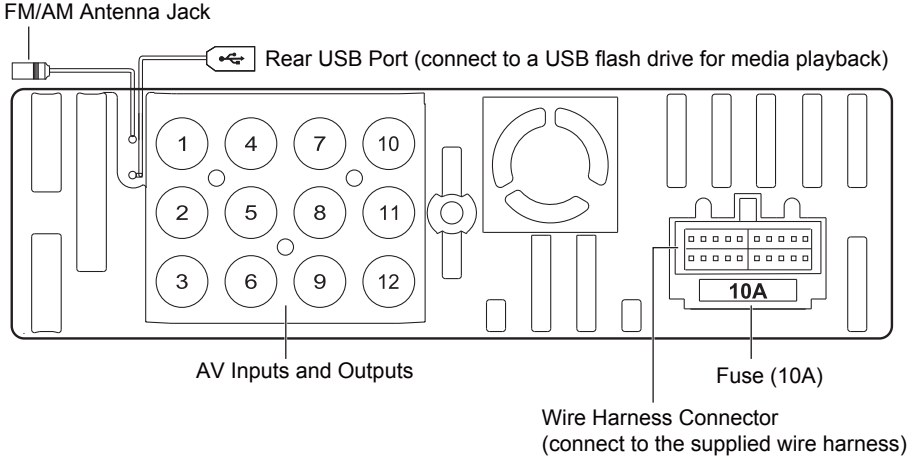

Audio/Video Inputs and Outputs

- | | |
|--|--|
| 1. R.CAM Rear Camera Input (Yellow) | 7. F. CAM Front Camera Input (Yellow) |
| 2. SUB1Sub Pre-amp Output (Green) | 8. R L Rear Left Pre-amp Output (White) |
| 3. SUB2 Sub Pre-amp Output (Green) | 9. R R Rear Right Pre-amp Output (Red) |
| 4. V-INVideo Input (Yellow) | 10. V-OUT Video Output (Yellow) |
| 5. L-INLeft Audio Input (White) | 11. F L Front Left Pre-amp Output (White) |
| 6. R-INRight Audio Input (Red) | 12. F R Front Right Pre-amp Output (Red) |

Wire Harness

Power

- Yellow..... Constant (+12V)
- Red..... Accessory (+12V)
- Black..... Ground (-)
- Orange/White..... Dimmer Input (+12V)
- Purple/White..... Reverse Input (+12V)
- Blue..... Antenna Output (+12v, 500 mA)
- Blue/White..... Rem. Output (+12v, 500 mA)
- Light Green..... Parking Brake Input

SWC Control

- 3.5mm Plug (Orange)..... SWC Input

Speaker Outputs

- White..... Left Front (+)
- White/Black..... Left Front (-)
- Gray..... Right Front (+)
- Gray/Black..... Right Front (-)
- Green..... Left Rear (+)
- Green/Black..... Left Rear (-)
- Purple..... Right Rear (+)
- Purple/Black..... Right Rear (-)

Camera Power

- Red/Purple..... Front Output (+12V, 500 mA)
- Red/White..... Rear Output (+12V, 500 mA)

PANEL INTRODUCTION

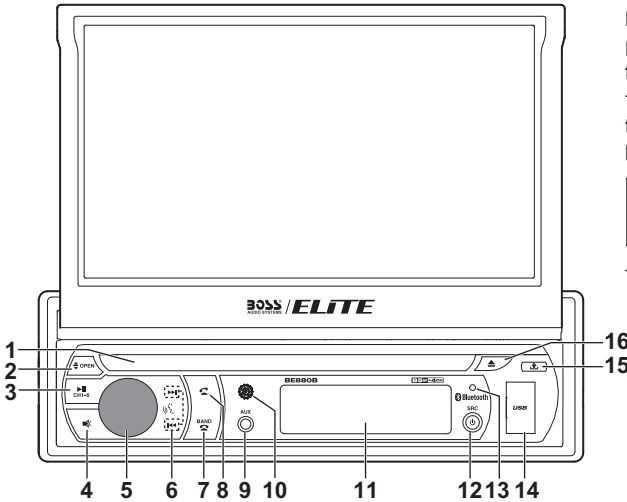

Detachable front panel

Press (15) to unlock and remove the front panel. The reset button is accessed.

To replace the front panel, first align the tab on the left (as arrow shown), then push the front panel in place.

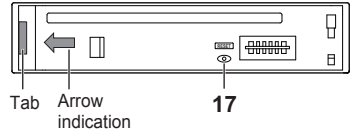

- 1 Disc Slot**
- 2 OPEN**
 - Press to slide the screen out.
 - Repeatedly press to tilt the screen up or down.
 - Hold down to slide the screen in.
- 3 / CH1-6**
 - Start, pause or resume playback.
 - In radio mode, select a radio station.
- 4 MUTE**
 - Mute or restore volume.
- 5 Volume knob / (Push-To-Talk)**
 - Rotate to adjust volume.
 - Press to access smartphone voice assistant capability via Bluetooth.
- 6 /**
 - In radio mode, press briefly to tune to a station; press and hold to enter manual seeking mode to fine tune frequencies.
 - During media play, press to skip to the previous or next track; hold down to fast search forward or backward.
- 7 BAND /**
 - Select a tuner band.
 - Eject or end a Bluetooth phone call.
- 8**
 - Dial or answer a Bluetooth phone call.
- 9 AUX Jack (3.5mm)**
 - Connect to an external audio device for audio input.
- 10 Remote Sensor**
 - Receive signal from the remote control.
- 11 Display**
 - Show current status.
- 12 / SRC**
 - Press to power the unit on; hold down to power the unit off.
 - Select a source.
- 13 Built-in Microphone**
 - Pick up sound for voice assistant and hands-free calls via Bluetooth connection.
- 14 USB Port**
 - Connect to a USB flash drive for media play.
 - Connect to an Android mobile phone for A-LINK usage.
- 15**
 - Press to detach the front panel.
- 16**
 - Eject the disc.
- 17 Reset button**
 - Press the reset button if the unit fails to operate properly.

REMOTE CONTROL INTRODUCTION

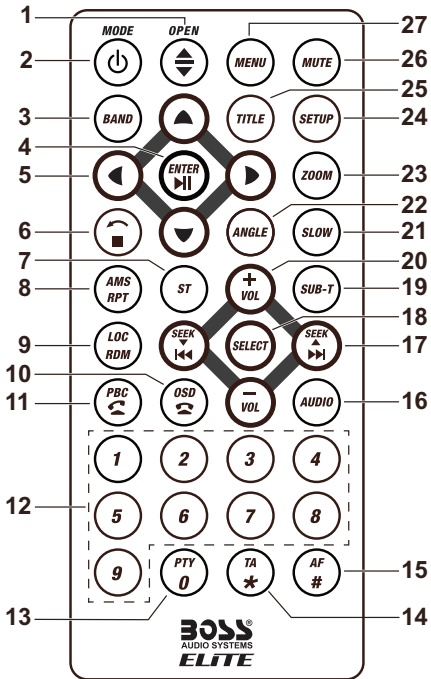

1 OPEN /

- Press to slide the screen out.
- Repeatedly press to tilt the screen.
- Hold down to slide the screen in.

2 / MODE

- Press to power the unit on; hold down to power the unit off.
- Select a source.

3 BAND: Select a tuner band.

4 ENTER: Confirm a selection. : Start, pause or resume playback.

5 / / / : Navigate menus.

6 : Return to a previous menu screen. : Stop video/picture playback.

7 ST: In FM radio, switch between stereo and mono reception.

8 AMS: In radio mode, press and hold to auto store radio stations; press briefly to preview each stored station. RPT: Select a repeat play mode.

9 LOC: In FM radio, select local or distant reception.

RDM: Select random play.

10 OSD: Display playback menu during video/picture playback.

: Eject or end a Bluetooth phone call.

11 PBC: During VCD/SVCD play, display or skip the content menu of the disc.

: Dial or answer a Bluetooth phone call.

12 Numeric buttons

- Select a title/chapter/track.
- In radio mode, select a preset station.
- In Bluetooth phone mode, enter a phone number.

13 PTY: In RBDS radio, turn on or off PTY (Program Type) function.

14 TA: In RBDS radio, turn on or off TA (Traffic Announcement) function.

15 AF: In RBDS radio, turn on or off AF (Alternative Frequencies) function.

16 AUDIO: During video play, select an audio language or channel (if available).

17 SEEK / / /

- In radio mode, press briefly to tune to a station; press and hold to enter manual seeking mode to fine tune frequencies.
- Skip to the previous or next chapter, track or file.
- Long press to search forward and backward with x2, x4, x8, x16 speed.

18 SELECT: Press and hold to access audio, settings and press briefly to confirm selection.

19 SUB-T: During video play, select a subtitle language if available.

20 VOL +/-: Adjust volume.

21 SLOW: During video play, select a slow forward speed (if available).

22 ANGLE: During video play, select a camera camera angle (if available).

23 ZOOM: Zoom in or out a picture.

24 SETUP: Access setup menu.

25 TITLE: Access the main menu of a video disc.

26 MUTE: Mute or restore volume.

27 MENU: Access the root menu.

MAIN MENU OPERATION INSTRUCTION

MAIN MENU 1

1. Tuner Interface
2. Streaming Interface
3. DISC Interface
4. Phone Interface
5. Front USB Interface
6. Rear USB Interface
7. Front/Rear Camera Interface
8. AV INPUT Interface

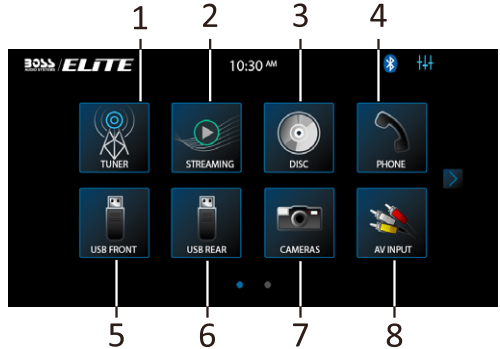

MAIN MENU 2

9. AUX IN Interface
10. Setting Interface
11. A-LINK(Autolink) Interface

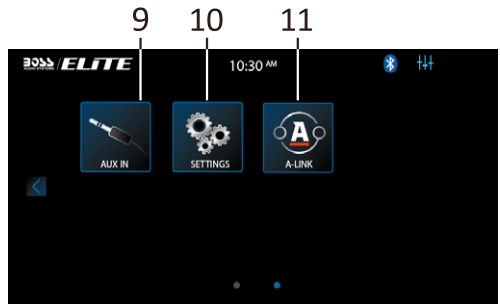

There are eight Setting Menus

General SETTINGS-Menu 1

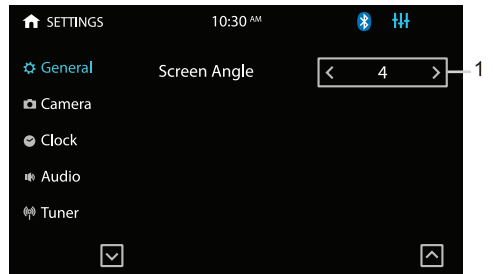
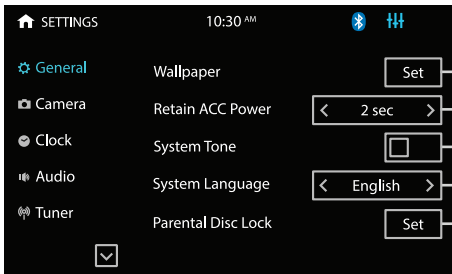

1. Touch to set wall paper for the home menu background.
2. Retain ACC Power: select how many seconds to delay shut down of the unit after the vehicle powers down.
3. When turned on, an audible beep tone confirms each function selection.
4. Touch to select Spanish or English.
5. Touch to set a parental control level. The default password is "0000".
6. Touch to set a screen angle from four options.

ACCESS SETUP INTERFACE

Camera SETTINGS-Menu 2

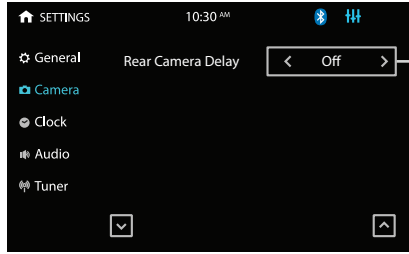
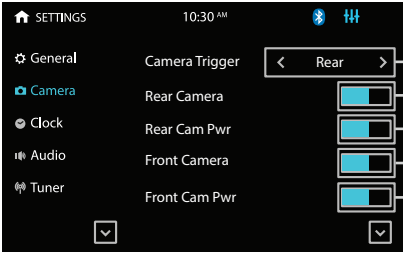

1. Camera Trigger: Touch to select Front/Rear/Off. Select to display the front or rear camera view, or no camera view when reversing.
2. Rear Camera: Touch to enable or disable the rear camera input.
3. Rear Cam Pwr: Touch to enable or disable power output to the rear camera.
4. Front Camera: Touch to enable or disable the front camera input.
5. Front Cam Pwr: Touch to enable or disable power output to the front camera.
6. Rear Camera Delay / Front Camera Delay: Touch to delay trigger of the camera view by a set time (1/2/3 seconds or off) when shifting the gear to the reverse position. Due to varying vehicle configuration, the camera view trigger can be delayed to suit the vehicle.

Clock SETTINGS-Menu 3

- a. Touch to set clock mode: 12/24 hour.
- b. Touch to set hours.
- c. Touch to set minutes.
- d. Touch to set AM/PM at 12 hour mode.

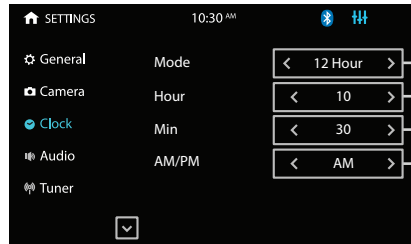

Audio SETTINGS-Menu 4

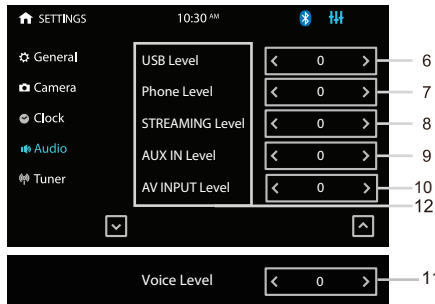
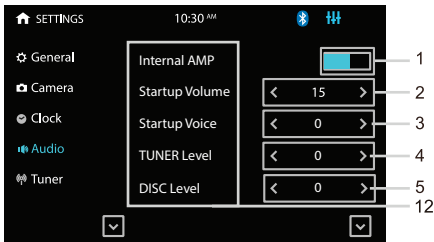

ACCESS SETUP INTERFACE

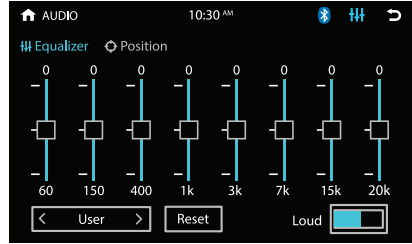
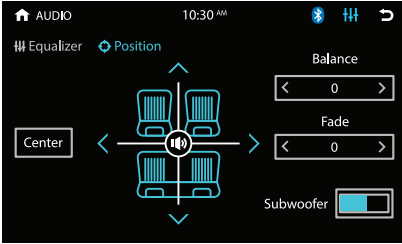

1. Touch to select whether to output sound from an external amplifier.
 2. 3. Startup volume & Startup voice: Set a default volume.
 - ① If the volume at the last shutdown is less than this volume, the volume at the last shutdown will be used when rebooting;
 - ② If the volume at the last shutdown is greater than this volume, this default volume will be used when rebooting.
 - 4-11. Touch to set a particular volume level for each source.
 12. Slide up or down to enter the previous or next menu interface.
- Position:** Touch to access setup of balance, fader and subwoofer.
Equalizer: Touch to access setup of equalizer and loudness.

Tuner SETTINGS –Menu 5

1. Select America or EU region you are in to receive radio stations.
2. Perform radio search and store radio stations in each radio band.
3. Select “Local” to receive strong signal only. Select “Distance” to receive both strong and weak signals
4. Turn on or off RBDS function. Select “Set” to access RBDS setting options.
5. Select “Stereo” or “Mono” sound effect.

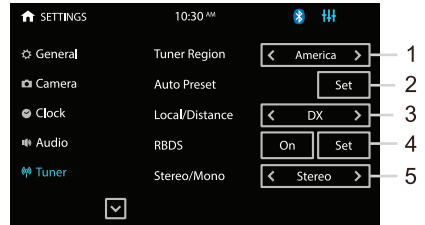

Controls Color SETTINGS –Menu 6

1. Touch to set illumination color for the control panel backlights: Auto, Green, Blue, Red, Yellow, Cyan, Purple, White.

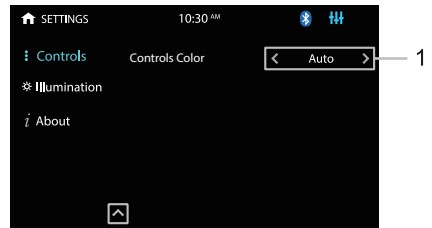

Illumination SETTINGS –Menu 7

1. Enable or disable night detection and auto dimming. Make sure the Dimmer Input wire (orange/white) is connected to the parking light.
2. Touch to set screen brightness.
3. Touch to set gamma brightness.

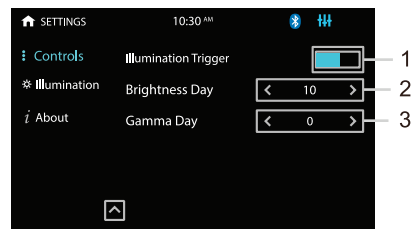

TUNER OPERATION

About SETTINGS –Menu 8

1. Calibrate the touch screen to improve responsiveness and accuracy. Touch the crosshair on the screen each time it appears to calibrate the screen.
2. View version numbers of this product
3. Restore the product to factory settings.
4. Enable/disable display of the End User License Agreement when booting up.

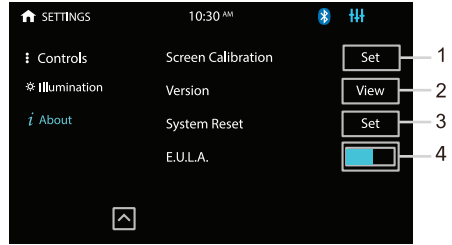

TUNER OPERATION

1. Touch to go back to the home page.
2. Show PS, PTY and RT messages from RBDS.
3. Short press to seek backwards, long press to enter manual mode.
4. Touch to select a tuner band (FM1/ FM2/FM3/AM1/AM2).
5. Short press to select the preset station, long press to save the current station as a preset.
6. Touch to search and store the available FM or AM stations.

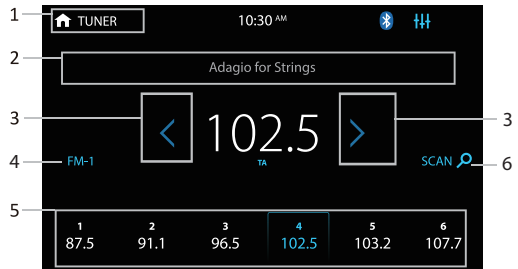

RBDS: Touch **SETTINGS>Tuner> RBDS** to access the RBDS setup menu.

a. CT (Clock Time)

Turn on to automatically correct the current time every time the RBDS is enabled.

b. TA (Traffic Announcement)

When enabled, the unit will automatically switch to radio mode to broadcast traffic information if received despite the currently selected source.

Once the traffic announcement is complete, the unit will automatically switch back to the previous source.

c. AF (Alternative Frequencies)

When the AF function is turned on, the radio will automatically fine tune to other frequencies when the received station becomes weak. A warning message will be displayed on the screen when receiving emergency announcements.

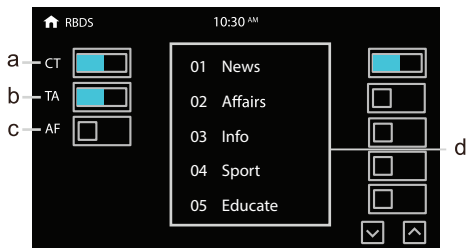

DISC/CD/USB PLAYBACK

d. PTY (Programming Type)

Touch an on-screen button to select a program type. The unit will search for the selected program and broadcast it.

NOTE: If RBDS is turned OFF, CT/TA/AF/PTY will not function.

DVD/VCD MODE OPERATION

Touch the “DISC” icon in the main menu to enter the DVD playback interface.

1. Touch to select a title/chapter of DVD.
2. Short press to move to the previous chapter; long press to rewind quickly.
3. Touch to playback/pause.
4. Short press to move to the next chapter; long press to fast forward quickly.
5. Touch to enter the DVD root menu.
6. Go to the next page of the menu bar.
7. Go to the previous page of the menu bar.
8. Touch to change the repeat mode in the following sequence:
DVD: repeat all, repeat off, repeat chapter, repeat title.
VCD (PBC off): repeat all, repeat off, repeat single.
9. Touch to change random play mode.
10. Touch to enter video adjust page to adjust Gamma and contrast of video.
11. Touch to enter the DVD title menu.
12. Touch to select the subtitle language if the disc is recorded in multiple languages.
13. Go to the next page of menu bar.
14. Touch to switch the picture format between 4:3 and 16:9.
15. Touch to select DVD video angle.
16. Touch to select DVD audio language.

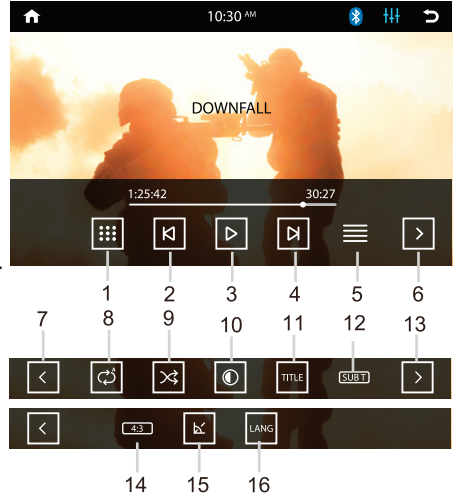

NOTE: When properly installed, a video cannot be displayed unless the parking brake is applied. If the parking brake wire is not installed correctly, a warning message will appear.

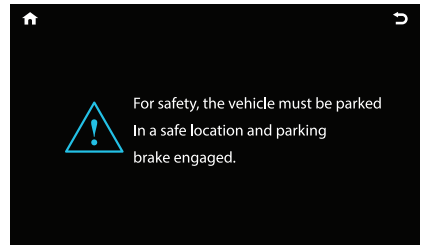

DISC/CD/USB PLAYBACK

MEDIA PLAYING—CD AUDIO

Touch the “DISC” icon in the main menu to access the CD track playback interface.

1. Show the music’s ID3 information.
2. Skip to the previous song.
3. Change play mode: repeat all, repeat single, sequential play and shuffle play.
4. Play/Pause.
5. Time bar: show the elapsed time and total time of the current song/track number.
6. Skip to the next song.
7. List: Touch to enter root menu.
8. View the Music/Photo/Video files.
9. Go to the previous or next page of list.

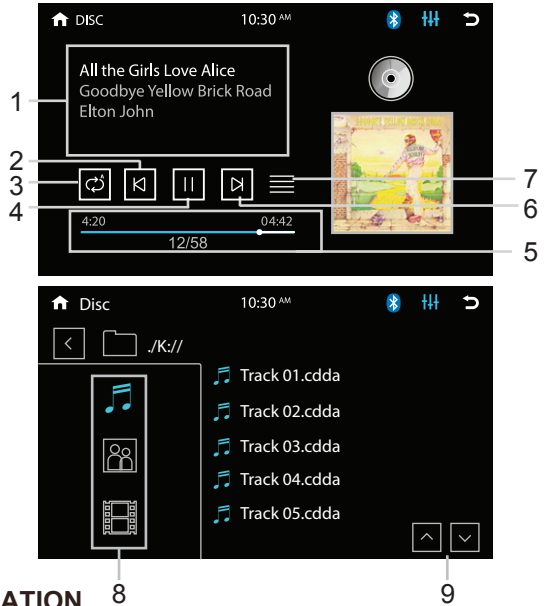

USB MUSIC/VIDEO/PICTURE OPERATION

Touch “USB FRONT” or “USB REAR” on the home screen. The music menu is similar to the disc music menu except more ID3 information (such as song name & singer).

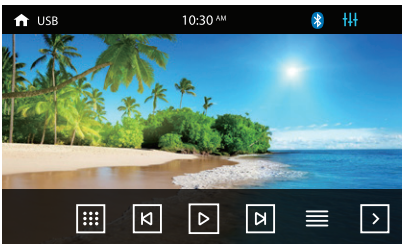
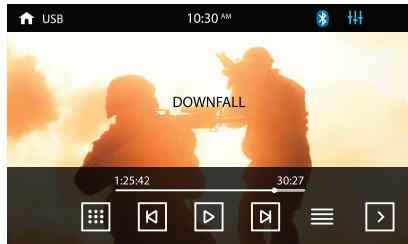
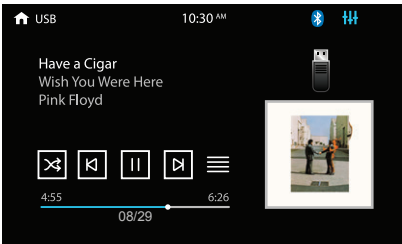

1. [Keypad] Keypad: Enter number to select file.
2. [Previous] Previous Music/Video/Picture
3. [Play/Pause] Play/Pause
4. [Next] Next Previous Music/Video/Picture
5. [List] List: Press to enter media file list
6. [Next Page] Go to the next page of menu bar
7. [Previous Page] Go to the Previous page of menu bar
8. [Repeat] Select repeat mode
9. [Random] Touch to change random play mode.
10. [Video Adjust] Enter Video adjust page to adjust gamma and contrast
11. [Rotate] Turn right 90 degree
12. [Zoom] Zoom In/Out

DISC/CD/USB PLAYBACK

MUSIC OPERATION

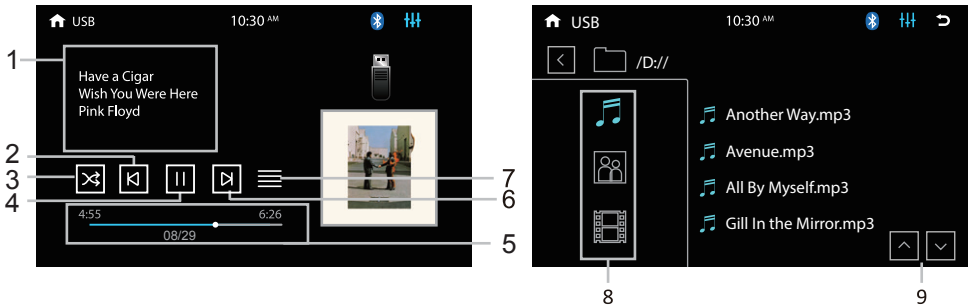

1. Show the music's ID3 information.
2. Skip to the previous song.
3. Change play mode: repeat all, repeat single, sequential play and shuffle play.
4. Play/Pause.
5. Time bar: show the elapsed time and total time of the current song/track number.
6. Skip to the next song.
7. List: Touch to enter song file list.
8. View the Music/Photo/Video files.
9. Go to the previous or next page of list.

PHOTO OPERATION

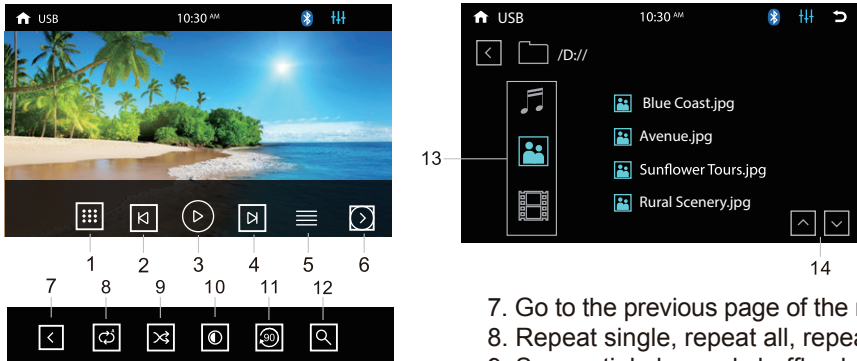

1. Keypad: Enter the number to select photo.
2. Skip to the previous photo.
3. Play/Pause.
4. Skip to the next photo.
5. List: Touch to enter photo file list.
6. Go to the next page of the menu bar.
7. Go to the previous page of the menu bar.
8. Repeat single, repeat all, repeat cancel.
9. Sequential play and shuffle play.
10. Touch to enter photo adjust page to adjust Gamma and contrast of image.
11. Turn right 90 degree.
12. Zoom In / Out.
13. View the Music/Photo/Video files.
14. Go to the previous or next page of list.

BLUETOOTH OPERATION

BLUETOOTH OPERATION MENU

Touch the “PHONE” icon on the home screen to enter the Bluetooth function interface.

1. Bluetooth setting menu:

a. Turn Bluetooth on and off.

When Bluetooth is not connected, the Bluetooth icon on the screen flashes. When Bluetooth is connected, the icon turns to steady from flashing.

b. Connect automatically.

c. Answer automatically.

d. PIN code: 0000. When prompted for password, input 0000 on your mobile phone for Bluetooth connection.

e. Bluetooth name for this unit: BOSS AUDIO ELITE BE880B

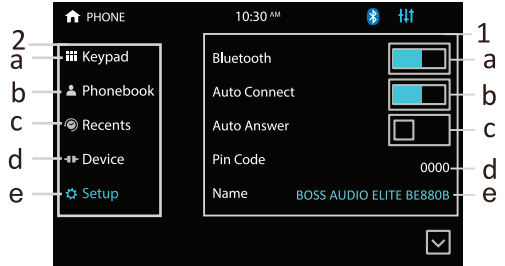

2. Function area:

a. Touch to see the dialing keypad. Users can dial phone numbers and make calls.

b. Touch to see the Bluetooth phonebook menu.

c. Touch to see the Bluetooth call history.

d. View Bluetooth connected devices.

e. Access Bluetooth settings menu.

BLUETOOTH DIALING

1. Show the number dialed in.

Press to delete input numbers.

2. Key area.

3. Touch to call out.

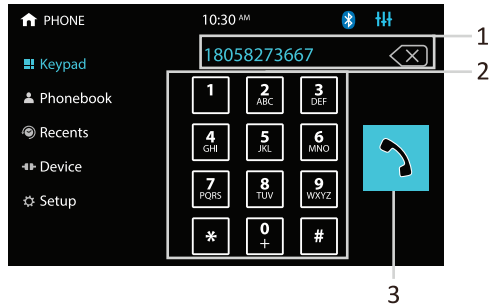

BLUETOOTH CALL

1. Show contact name being called.

2. Touch to select talk through phone or through this unit.

3. Keypad area.

4. Touch to hang up the phone call.

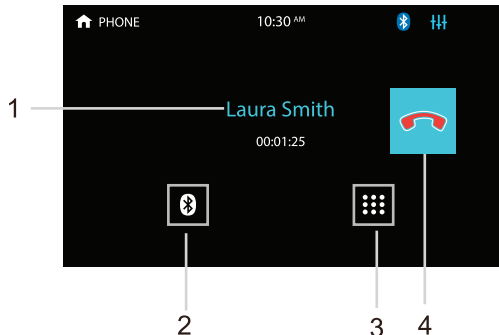

BLUETOOTH OPERATION

BLUETOOTH PHONE BOOK

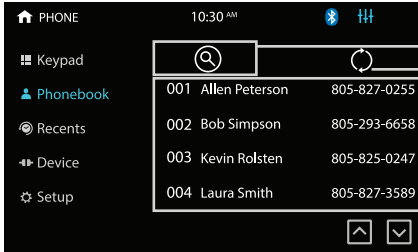

1. Touch to search for a name or phone number.
2. Touch to sync phonebook.
3. Contact list.

BLUETOOTH PHONE CALL HISTORY

1. Touch to sync phone call history.
2. Touch to show missed calls.
3. Touch to show the dialed phone numbers.
4. Touch to show the received phone numbers.

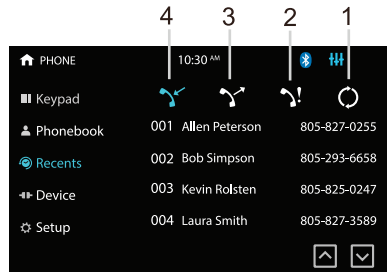

BLUETOOTH PAIRED DEVICE

1. Touch to view the device connected to this unit.
2. Touch the device name to disconnect the device.

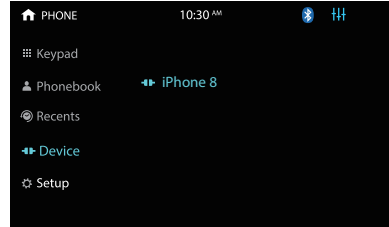

BLUETOOTH MUSIC STREAMING

When Bluetooth is connected, touch the "STREAMING" icon on the home screen for music streaming.

1. Skip to the previous song.
2. Play/pause.
3. Skip to the next song.
4. Enter the sound settings menu.

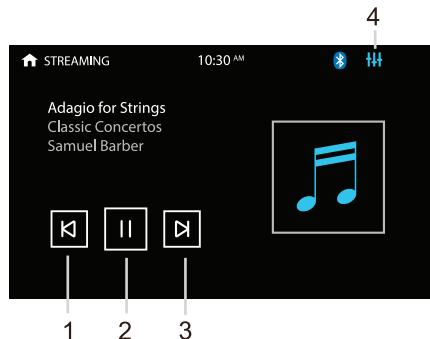

A-LINK(SCREEN MIRRORING) OPERATION

A-LINK App allows you to mirror the screen of certain Android smartphones on the screen of this unit.

Scan either of the QR codes to download the “A-LINK” App in Amazon App Store or Google Play Store and install it to your smartphone.

Simply connect your smartphone to the USB port on the front panel using the original cable of your smartphone. You will see the favorite smartphone apps directly on the screen of this unit.



Amazon
App Store



Google
Play Store

Note:

1. Supports 2 way control for Android device.
2. Supports Android 8.0+ or higher, not all apps are supported.

PTT(PUSH-TO-TALK) OPERATION

This Push-To-Talk feature allows direct access to Android and IOS smart-phones voice assistant capability when you establish the Bluetooth connection between your smartphone and this unit. Press the  button on the front panel to use the function when Bluetooth connection is made.

Note:

- Before using the Push-To-Talk, you must enable the mobile data on your smartphone.
- To use the navigation feature, switch to the BT Audio source to hear voice commands over the speakers of your vehicle.

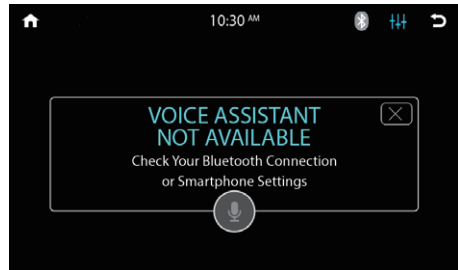
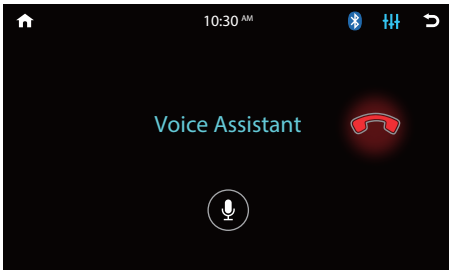

STEERING WHEEL CONTROL (SWC)

SWC INTRODUCTION

Steering Wheel Control (SWC) function allows you to operate this unit via an external device (steering wheel control).

A third-party adapter must be used in order for this unit to be compatible with your OEM steering wheel controls. We recommend PAC SWC series.

This unit has a built-in 3.5mm SWC interface that is compatible with many popular 3rd party SWC control modules, such as PAC, METRA, and others.

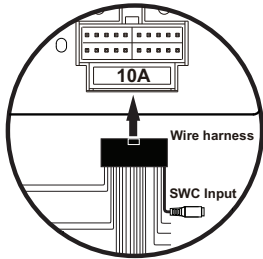

* Your product design may differ.

3.5mm SWC port is located on the supplied wire harness which is plugged into the rear panel of the unit.

PROGRAMMABLE CONTROLS

The following radio / audio function controls are available to be programmed.

Source	Volume -
Mute	Band
Home	Phone Menu
Seek + / Next Track	Bluetooth Talk
Seek - / Previous Track	Bluetooth End Call
Volume +	Voice Assistant / PTT

SWC INSTALLATION / PROGRAMMING

Contact your local installation expert for the correct SWC adapter for your specific vehicle.

1. For most SWC adapters, select program using "Pioneer/Sony/Other" mapping order as described in "PROGRAMMABLE CONTROLS".
2. When programming, if a function is not supported (or not desired), then the function MUST be skipped as per the SWC module instructions.
3. The SWC function MUST be programmed in the correct order as per the function mapping order instructions.

Note

- Not all OEM steering wheel functions may be supported.
- For SWC programming technical assistance, call the number in your SWC instruction manual.

TROUBLESHOOTING

Messages displayed	Cause	Corrective Action
Loading	Disc is being read.	Wait until the reading finishes.
No Disc/Bad Disc	Disc is dirty.	Clean the disc.
	Disc is upside down.	Insert the disc in the right way.
Unknown Disc	Unsupported disc type.	Check and change the disc.
Error	Illegal mechanism operation.	Press ▲ for 5 seconds to reset loading mechanism.
Problem	Cause	Corrective Action
Unit not powered on	Unit's fuse is blown.	Install a new fuse with right rating.
	Car battery fuse is blown.	Install a new fuse with right rating.
	Illegal operation.	Press the RESET button.
Insensitive screen touch	Place of touch screen is offset.	Calibrate the screen (SETTINGS > About > Screen Calibration).
No audio output	Improper audio output connection.	Check and correct the wiring.
	Volume is set to zero.	Turn up the volume.
Low audio output	Heavily biased volume balance.	Check and adjust the audio balance to the center position.
Poor sound quality or distortion	Speaker power rating is not compatible with unit.	Connect proper speakers.
	Speaker is circuit shorted.	Check speaker wiring.
Poor radio reception	Auto antenna is not properly connected.	Connect and extend the auto antenna properly.
	Local function is activated.	Activate Distance (DX) function.
No image	Parking wire is not connected.	Connect and check the wiring.
	Parking brake is not engaged.	Stop the vehicle in a safe place and engage the parking brake.
Flashing image or interference occurring	Video signal connection is not properly connected.	Check and correct the wiring.
Improper image, improper height/width display	Image aspect ratio is not properly set up.	Change the aspect ratio to the right one.
Disc not possible to be inserted.	A disc is already inside the disc slot.	Eject the disc and insert a new one.
Intermittent noise occurring during play	Disc is scratched or warped.	Use a new disc in good condition.
	Disc is dirty or wet.	Clean the disc.



BOSS Audio Systems
3451 Lunar Court • Oxnard, CA 93030
www.bosssaudio.com
805-751-4853 Customer Service
Tech Support: www.bosssaudio.com/support



0423

iPhone® are trademarks of Apple, Inc. registered in the U.S. and other countries. BOSS Audio Systems is not affiliated with Apple, Inc.

The Bluetooth® word mark and logos are registered trademarks owned by Bluetooth SIG, Inc. and any use of such marks by BOSS Audio Systems is under license. Other trademarks and trade names are those of their respective owners.