



# Iron/Impressions®

## 31" Enameled cast iron vanity top with integrated rectangular sink

### K-3049-8

#### Features

- 8" (203 mm) widespread faucet holes
- Sloped-wall rectangular basin

#### Material

- KOHLER® enameled cast iron

#### Installation

- Vanity top

#### Recommended Products/Accessories

K-9018 P-Trap  
K-23726 Drain treatment  
K-23725 Cast iron cleaner

#### Codes/Standards











ASME A112.19.1/CSA B45.2

#### KOHLER® Enameled Cast Iron Kitchen and Bathroom Sink Lifetime Limited Warranty

See website for detailed warranty information.

#### Available Colors/Finishes

*Color tiles intended for reference only.*

Color	Code	Description
	0	White
	FF	Sea Salt™
	96	Biscuit
	NY	Dune
	95	Ice™ Grey
	FT	Basalt
	7	Black Black™
	GRL	Grey Lavender
	DGB	Indigo Blue
	PLM	Black Plum

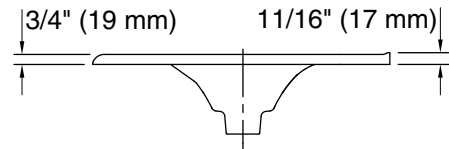
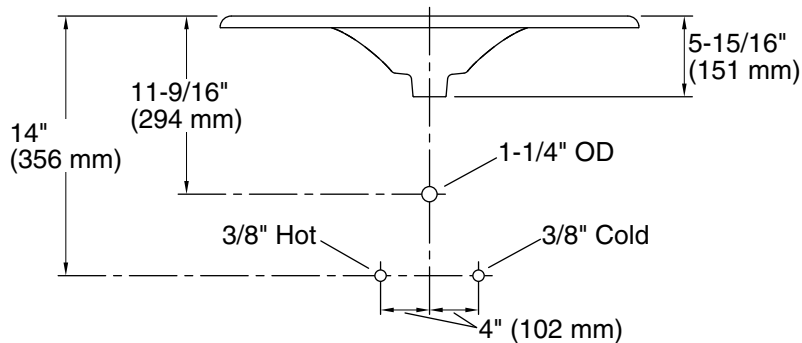
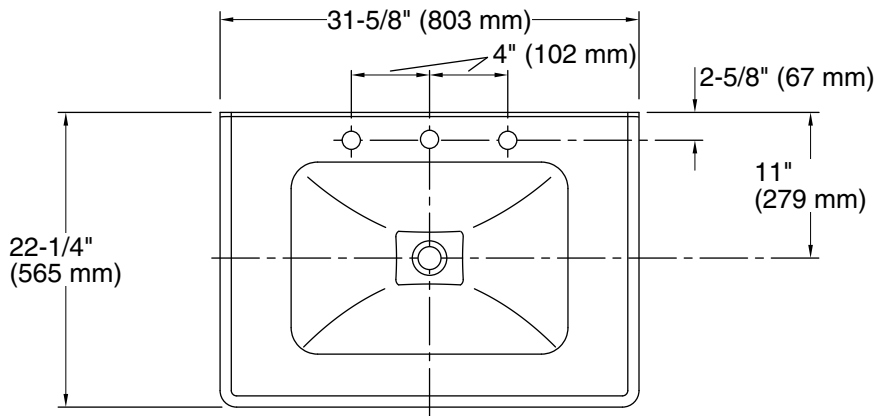

### Technical Information

All product dimensions are nominal.

Basin configuration:	Single Bowl
Center(s):	8" (203 mm)
Bowl area (Only):	Length: 20-7/8" (530 mm) Width: 14-1/2" (368 mm) Water depth: 4" (102 mm)
With overflow:	No
Number of deck holes:	3
Faucet hole(s):	1-3/8" (35 mm)
Drain hole:	1-3/4" (44 mm)

### Notes

Install this product according to the installation instructions.

NOTE: When selecting a faucet for this bathroom sink, ensure the faucet has a spout reach of 4-1/2" (114 mm) to 5" (127 mm) and has a spout height of 3" (76 mm) to 6" (152 mm).

Product does not have an overflow.