

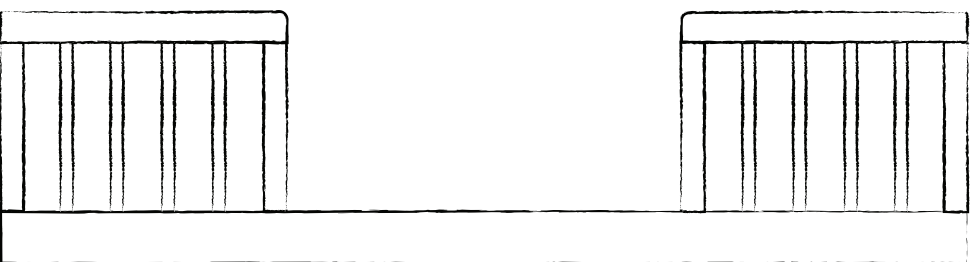

Toddler Bed Conversion Kit

M18399





Hi!

Pregnancy is a wild journey. We get it!

At MDB Co. we're obsessed with your child's safety, so you can focus on welcoming your baby home. Let's get started—it's time to set up the perfect space for your little one.

You've got this!
Million Dollar Baby Co.

¡Hola!

El embarazo es toda una odisea. ¡Lo entendemos!

En MDB Co. estamos obsesionados con la seguridad del bebé, para que usted pueda enfocarse en darle la bienvenida a su hogar. Comencemos—es hora de preparar el espacio perfecto para su pequeño.

¡Eso es!
Million Dollar Baby Co.

Bonjour!

La grossesse est ponctuée de hauts et de bas. Nous en sommes conscients!

Chez MDB Co. nous sommes obnubilés par la sécurité de votre enfant, vous pouvez donc vous concentrer sur l'arrivée de votre bébé à la maison. Mettons-nous au travail — il est temps d'aménager l'environnement idéal pour votre tout-petit.

Voilà!
Million Dollar Baby Co.

**GETTING
STARTED**

**PARA
COMENZAR**

**POUR
COMMENCER**

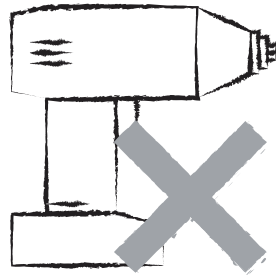
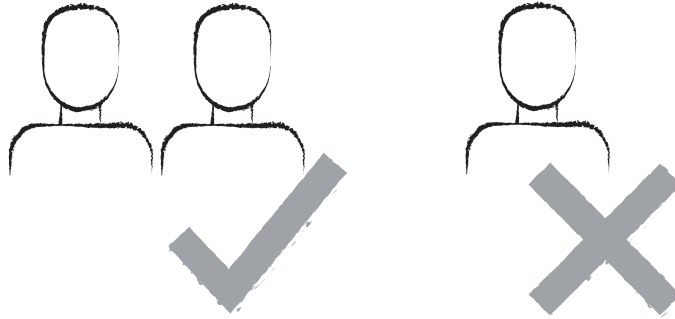

We'd love to chat with you (we're parents ourselves!), so don't hesitate to contact us with whatever questions you have.



Nos encantaría conversar con usted (¡también somos padres!), por eso no deje de contactarnos si tiene alguna pregunta.



Nous adorons discuter avec vous (nous sommes nous-mêmes des parents!), alors n'hésitez pas à nous contacter pour quelque question que ce soit.

THEMDBFAMILY.COM/SUPPORT

(323) 728-8988

PARTS

not to scale

PIEZAS

no a escala

PIEZAS

non dessinées à l'échelle

A



HARDWARE

actual size

HERRAJE

tamaño real

MATÉRIEL

taille actuelle

H1

x4

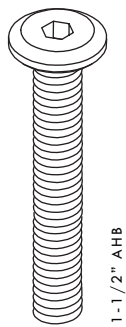

H2

x4

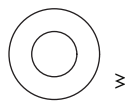

H3

x4



H4

x1

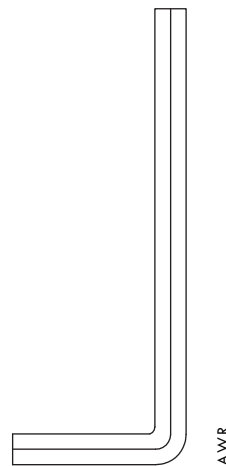

H5

x1

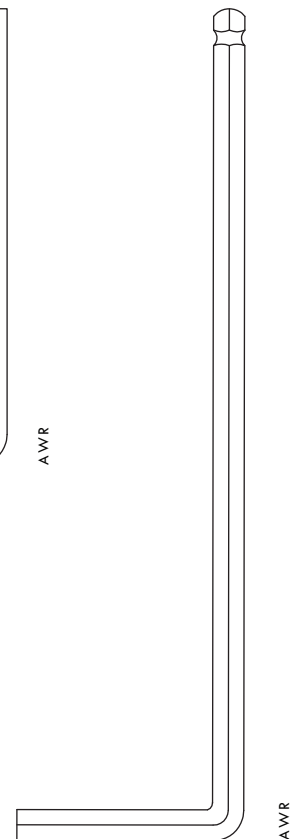

1

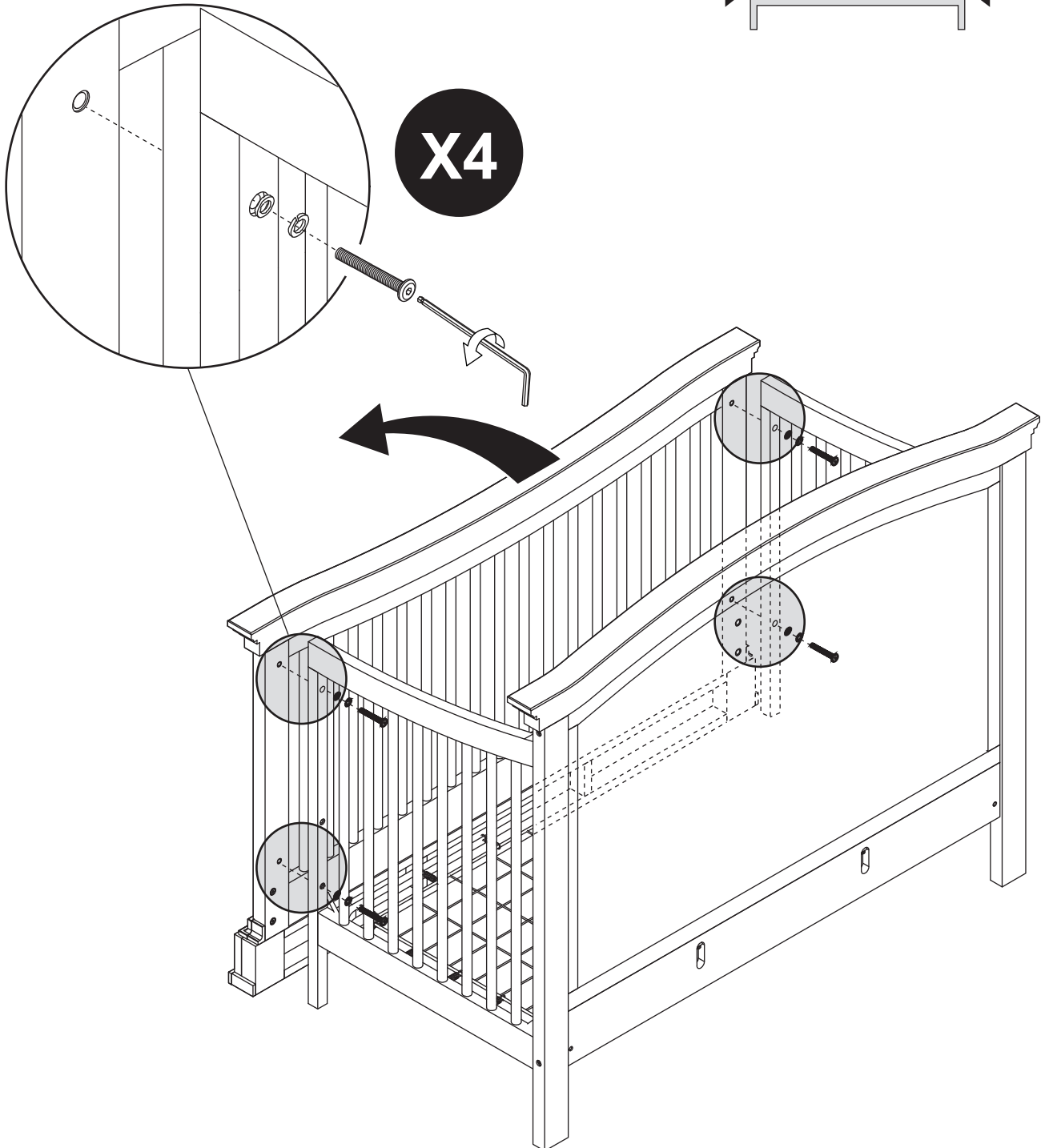
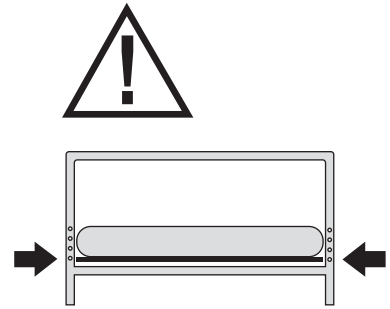

2

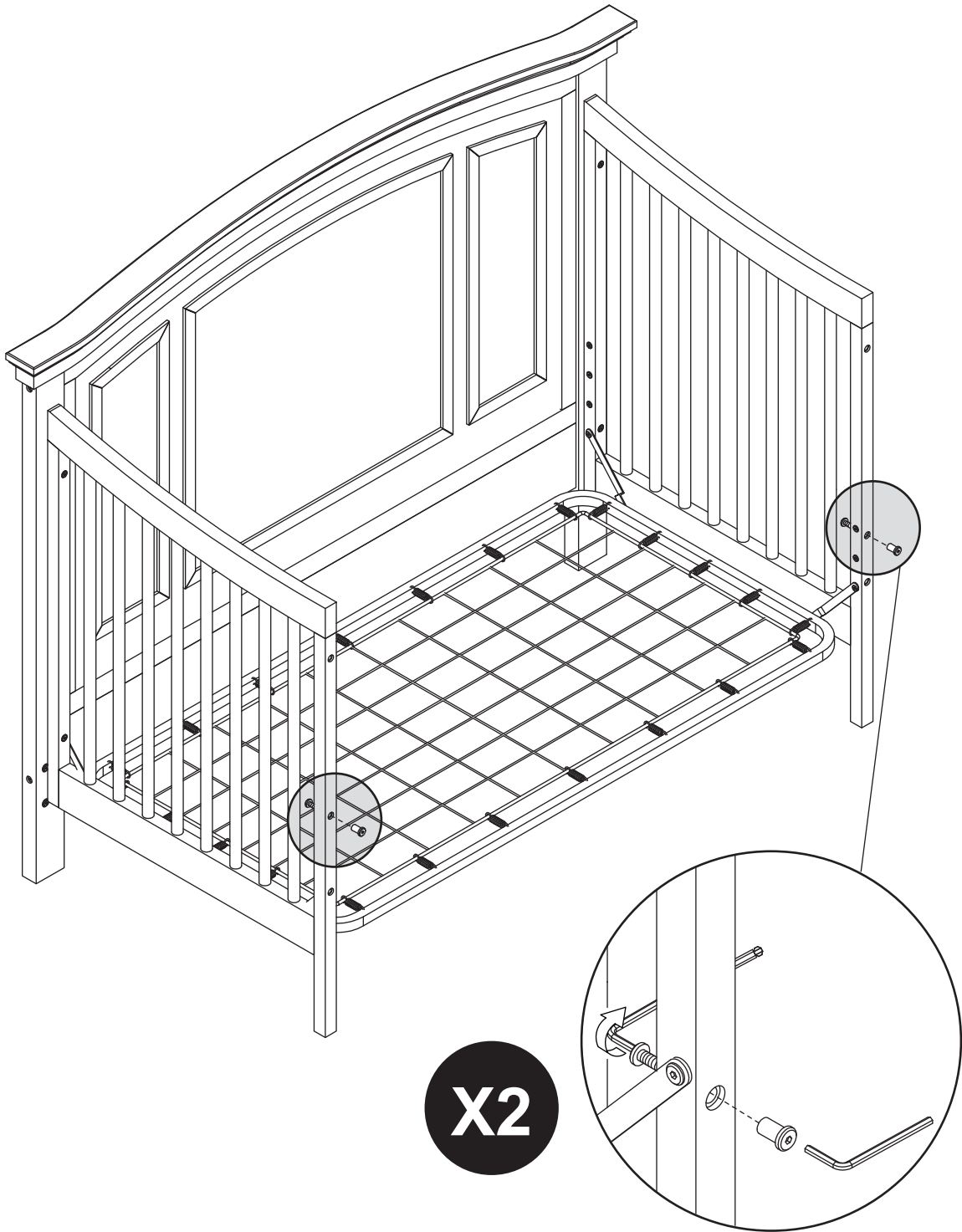

3

H1
X4

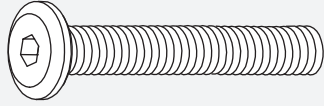

H2
X4



H3
X4

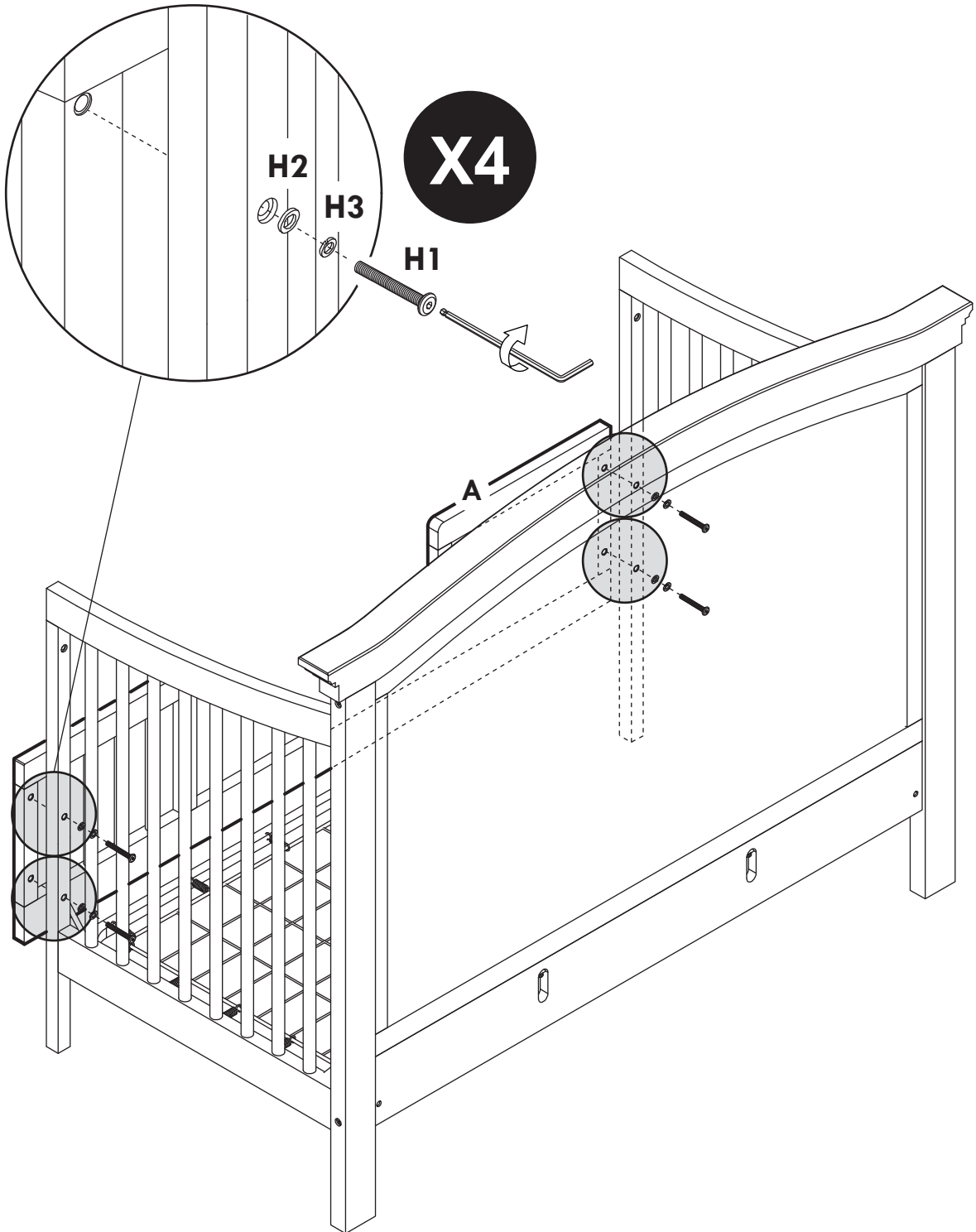

4

- * Use the same hardware from step 2.
- * Use el mismo herraje del paso 2.
- * Utilisez la même quincaillerie de l'étape 2.

X2

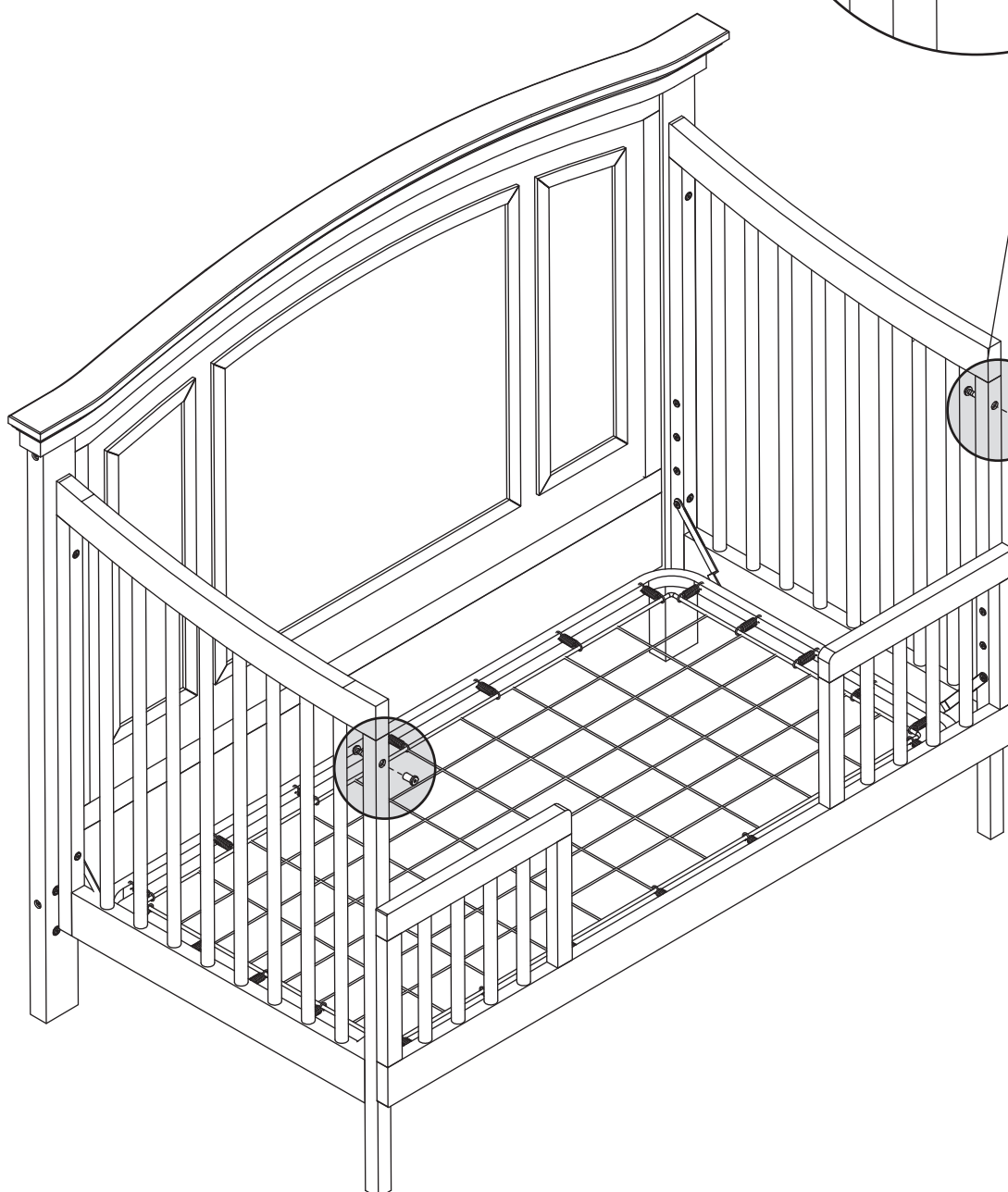
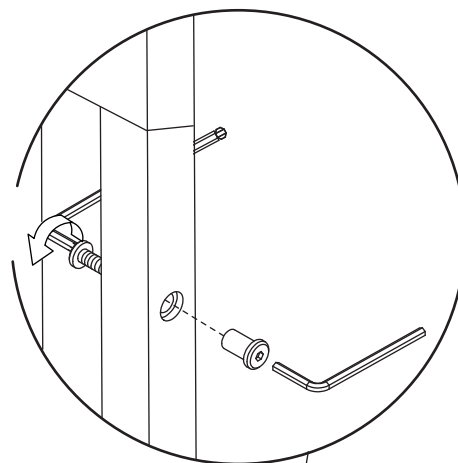

You did it!

¡Lo logró!

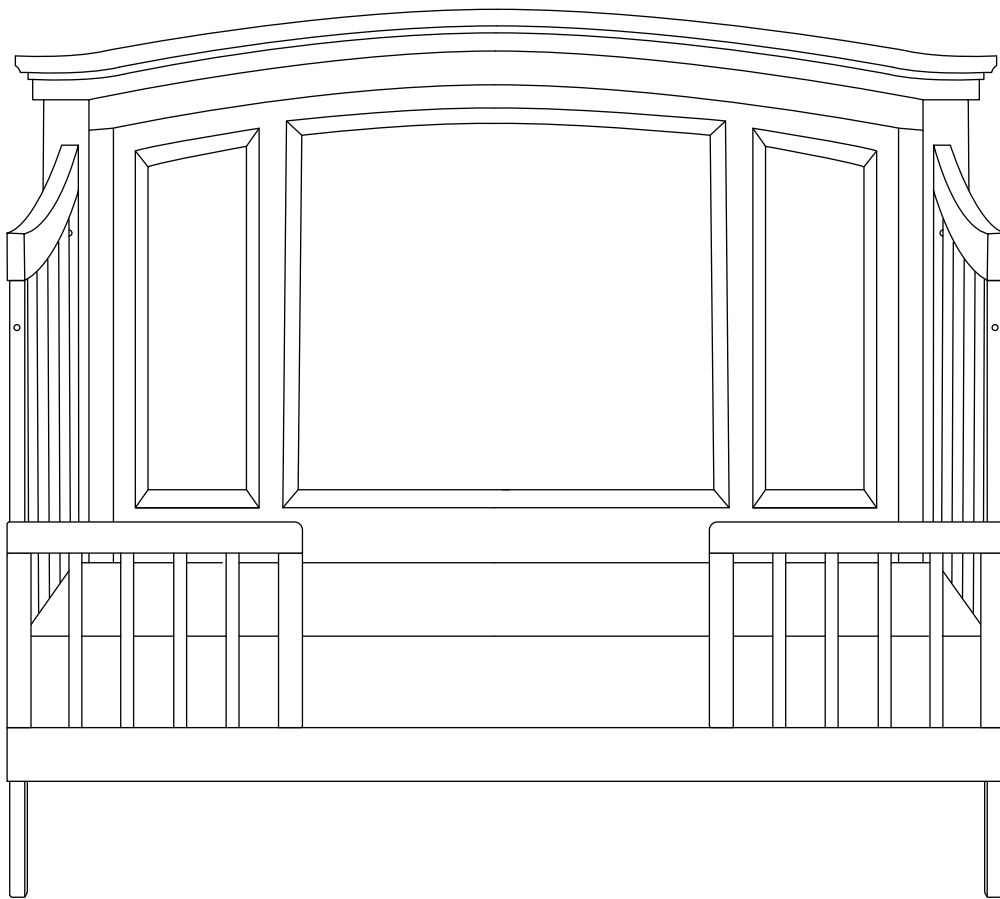

Vous y êtes!

WARNING

TO AVOID DANGEROUS GAPS, ANY MATTRESS USED IN THIS BED SHALL BE A FULL-SIZE CRIB MATTRESS AT LEAST 51 5/8 IN. (131 CM) IN LENGTH, 27 1/4 IN. (69 CM) IN WIDTH, AND A MAX THICKNESS OF 6 IN. (15 CM).

THE INTENDED USER'S MINIMUM AGE MUST BE AT LEAST 15 MONTHS OLD AND MAXIMUM WEIGHT MUST NOT EXCEED 50 LBS (22.7 KG).

ADVERTENCIA

PARA EVITAR HUECOS PELIGROSOS, TODO COLCHÓN UTILIZADO EN ESTA CAMA DEBE SER UN COLCHÓN DE CUNA DE TAMAÑO COMPLETO QUE MIDA POR LO MENOS 131 CM DE LARGO, 69 CM DE ANCHO, Y QUE TENGA UN ESPESOR MÁXIMO DE 15 CM.

LA EDAD MÍNIMA DEL USUARIO AL CUAL SE DESTINE DEBE SER DE 15 MESES Y SU PESO MÁXIMO NO DEBE SUPERAR 22.7 KG.

AVERTISSEMENT

POUR ÉVITER TOUT ÉCART DANGEREUX, LE MATELAS UTILISÉ DANS CE LIT DOIT ÊTRE UN MATELAS PLEINE TAILLE D'AU MOINS 131 CM (51 5/8 PO) DE LONGUEUR, 69 CM (27 1/4 PO) DE LARGUEUR ET D'UNE ÉPAISSEUR MAXIMALE DE 15 CM (6 PO).

L'ENFANT DOIT AVOIR AU MOINS 15 MOIS ET PESER AU MAXIMUM 22,7 KG (50 LB).

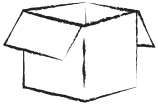

STORAGE

Because materials respond to temperature and humidity, it is important to store furniture in controlled environments. Furniture should not be placed in direct sunlight or near air-conditioning outlets, radiators, heaters, or humidifiers. Any changes such as extreme heat or cold, dampness, or dryness, may cause noticeable shrinkage or swelling of wood. Direct sunlight may affect the coloring of materials over time.



CARE & CLEANING

To clean wood or metal parts, use a lint-free, soft cloth with a non-toxic cleaner. Wipe dry immediately. To avoid scratches or other damages, do not use abrasive chemicals or materials. For fabrics, we recommend using a non-toxic foaming fabric cleaner or leather cleaner where appropriate. Touch up kits are available for purchase by contacting us:

323-728-8988

themdbfamily.com/support

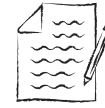

REGISTRATION

Registering your product is simple:
themdbfamily.com/support



PART REPLACEMENT

If you would like to order replacement or missing parts, please visit us:

themdbfamily.com/support

You can contact us by mail at,
8700 Rex Rd. Pico Rivera, CA 90660

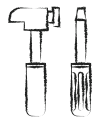

ONE YEAR LIMITED WARRANTY

Have an issue? We're here to help. Your MDB Co. product is covered under warranty for one year after the date of purchase. Visit us for more details on our warranty policy:

themdbfamily.com/support

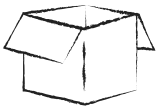

ALMACENAMIENTO

Dado que los materiales responden a la temperatura y la humedad, es importante guardar muebles en ambientes controlados. No deben ponerse los muebles a la luz solar directa ni cerca de salidas de aire acondicionado, radiadores, calefactores ni humidificadores. Cualquier cambio como los extremos de calor o frío, humedad o sequedad, pueden causar notoriamente encogimiento o hinchazón en la madera. La luz solar directa puede afectar la coloración de los materiales con el paso del tiempo.



CUIDADO Y LIMPIEZA

Para limpiar piezas de madera o metal, use un paño suave sin pelusa con un limpiador no tóxico. Seque con un paño inmediatamente. Para evitar rayar o dañar la superficie, no use agentes químicos ni materiales abrasivos. En cuanto a las telas, recomendamos usar una espuma limpiadora no tóxica para telas o un limpiador para cuero según corresponda. Hay kits para retocar disponibles para la venta contactándonos:

323-728-8988

themdbfamily.com/support



REGISTRARSE

Es sencillo registrar su producto:

themdbfamily.com/support



RECAMBIO DE PIEZAS

Si quisiera pedir repuestos o piezas faltantes, visítenos en:

themdbfamily.com/support

o puede contactarnos por correo en:
8700 Rex Rd. Pico Rivera, CA 90660

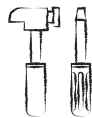

GARANTÍA LIMITADA DE UN AÑO

¿Tiene algún problema? Estamos aquí para ayudar. Su producto MDB Co. está cubierto por una garantía de un año a partir de la fecha de compra. Para conocer más detalles sobre nuestra política de garantía, visite:

themdbfamily.com/support

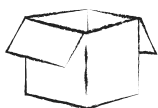

RANGEMENT

Compte tenu que les matériaux réagissent à la température et à l'humidité, il importe de ranger le mobilier dans des environnements contrôlés. Le mobilier ne doit pas être placé en plein soleil ni près des sorties d'air climatisé, des radiateurs, des appareils de chauffage ou des humidificateurs. Tout changement comme un froid ou une chaleur extrême, de l'humidité ou de la sécheresse pourrait causer la contraction ou le gonflement du bois. La lumière directe du soleil peut altérer la couleur des matériaux au fil du temps.



NETTOYAGE ET ENTRETIEN

Pour nettoyer le bois ou les pièces métalliques, utilisez un chiffon doux sans peluche et un produit nettoyant non toxique. Essuyez immédiatement. Pour éviter les égratignures ou autres dommages, veillez à ne pas utiliser des produits chimiques ou des matériaux abrasifs. Pour les tissus, il est recommandé d'utiliser un produit nettoyant pour tissus non toxique ou pour cuir le cas échéant. Il est possible de se procurer des nécessaires de retouches en nous contactant :

323-728-8988

themdbfamily.com/support



ENREGISTREMENT

L'enregistrement du produit est simple à réaliser :

themdbfamily.com/support



PIÈCES DE RECHANGE

Pour commander des pièces de rechange ou manquantes, veuillez visiter :

themdbfamily.com/support

ou communiquer avec nous par courriel à l'adresse:

8700 Rex Rd. Pico Rivera, CA 90660

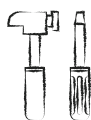

GARANTIE LIMITÉE D'UN AN

Vous avez un problème? Nous sommes là pour vous aider. Votre produit MDB Co. est couvert par une garantie d'un an à compter de la date d'achat. Pour plus de détails sur la politique de garantie, veuillez visiter :

themdbfamily.com/support

