

### Features

- 122 airjets release thousands of heated bubbles that surround, support, and massage the body
- Variable-speed blower lets you adjust massage intensity to 18 levels
- Built-in heater
- Automatic and manual purge cycles remove residual water from air channels after use
- 60-minute automatic shutoff timer
- Slotted overflow allows for deep soaking
- Integral lumbar support
- Keypad control
- Textured bottom surface

### Material

- Acrylic

### Technology

- Heated BubbleMassage™ technology warms and humidifies air before it enters the bath

### Installation

- Drop-in or undermount
- Reversible drain

### Required Products/Accessories

K-7271 Brass Slotted Overflow Bath Drain

or

K-7272 PVC Slotted Overflow Bath Drain

### Recommended Products/Accessories

K-1491 Bath/Whirlpool Pillow  
K-1601 Bath/whirlpool footstop, removable  
K-531 Under-Mount Installation Kit  
K-706000-D3 Frameless Sliding Bath Door  
K-706000-L 62" H sliding bath door with 1/4"-thick glass  
K-706004-D3 Frameless Sliding Bath Door  
K-706004-L Frameless Sliding Bath Door  
K-1177 Vinyl Tiling-in Bead



ADA

### Codes/Standards







ASME A112.19.7/CSA B45.10  
CSA B45.5/IAPMO Z124  
ASTM E162  
ASTM E662  
UL 1795  
CSA C22.2 No. 218.2  
ADA  
ICC/ANSI A117.1  
cUL Listed  
UL Listed

### KOHLER® Plastic Baths and Shower Bases Lifetime Limited Warranty KOHLER® Hydrotherapy Components Five-Year Limited Warranty

See website for detailed warranty information.

### Available Colors/Finishes

*Color tiles intended for reference only.*

Color	Code	Description
	0	White
	96	Biscuit
	NY	Dune
	95	Ice™ Grey
	58	Thunder™ Grey
	7	Black Black™

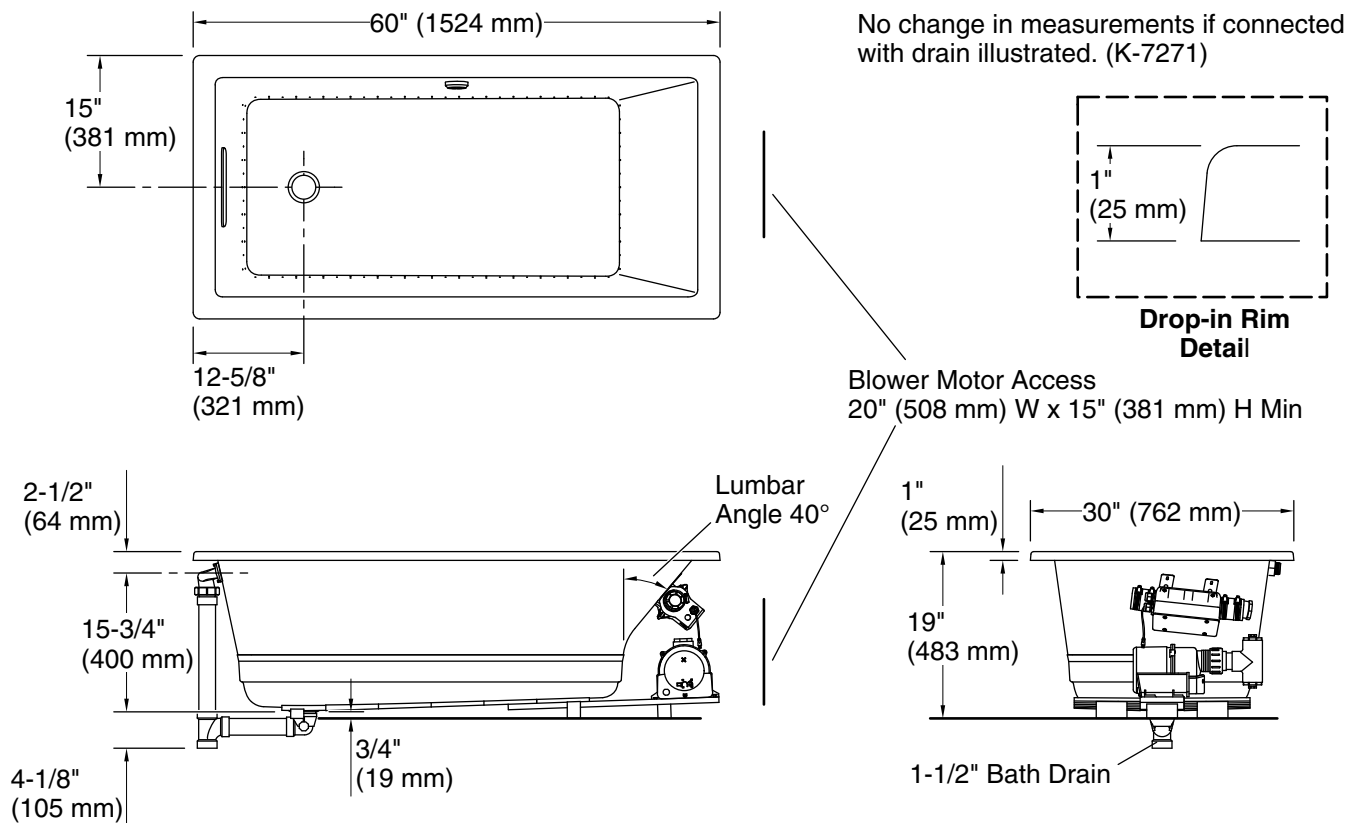

### Required Electrical Service

Two dedicated circuits required, protected with Class A Ground-Fault Circuit-Interrupter (GFCI). Outside North America, this device may be known as a Residual Current Device (RCD).

Blower: 120 V, 15 A, 60 Hz  
Air bath: 120 V, 15 A, 60 Hz

### Technical Information

All product dimensions are nominal.

Drain location: Reversible  
Basin area, bottom: 42-3/8" x 20" (1076 mm x 508 mm)  
Basin area, top: 54-3/8" x 24-5/16" (1381 mm x 618 mm)  
Weight: 96 lbs (43.5 kg)  
Minimum floor load: 50 lbs/ft² (244.1 kg/m²)  
Water depth: 15-1/16" (383 mm)  
Water capacity: 59.8 gal (226.4 L)  
Cutout: Drop-in, 59-1/2" x 28-1/2" (1511 mm x 724 mm)  
Electrical component rating: Blower: 120 V, 10 A, 60 Hz  
Air bath: 120 V, 5 A, 60 Hz

Blower speed: Variable

1-800-4KOHLER (1-800-456-4537)

Kohler Co. reserves the right to make revisions without notice to product specifications.

For the most current Specification Sheet, go to [www.kohler.com](http://www.kohler.com) USA or [www.kohler.ca](http://www.kohler.ca) Canada

8-26-2025 20:28 - US/CA

### Notes

Measure your actual product for rough-in details.

Install this product according to the installation instructions.

The hot water supply should be 70% of the capacity of the bath or greater. Installations will vary.

ADA compliant when installed to the specific requirements of these regulations.