

SAFETY INFORMATION

Please read and understand this entire manual before attempting to assemble, install or operate the product.

WARNING

- RISK OF ELECTRIC SHOCK - Before beginning installation, turn off electricity at the circuit breaker box or the main fuse box.
- RISK OF FIRE - Use bulbs specified by the markings and/or labels on the fixture.

CAUTION

- For your safety, read instructions completely before beginning installation.
- If in doubt about electrical installation, consult a licensed electrician.
- Turn off electricity to fixture before replacing the bulb(s).

TOOLS REQUIRED

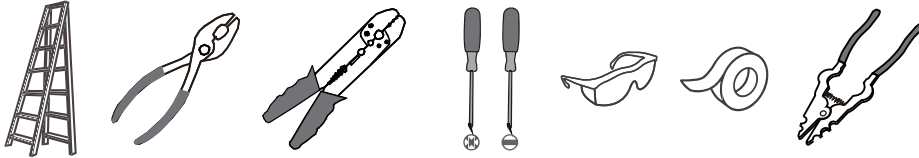

CARE AND MAINTENANCE

- Wipe clean using soft, dry cloth or static duster. Always avoid using harsh chemicals and abrasives to clean fixture as they may damage the finish.

If you need further assistance call Quozel Customer Care at 1-800-645-3184 (9:00am - 5:00pm EST), or visit us on-line at www.quezel.com.

PACKAGE CONTENTS

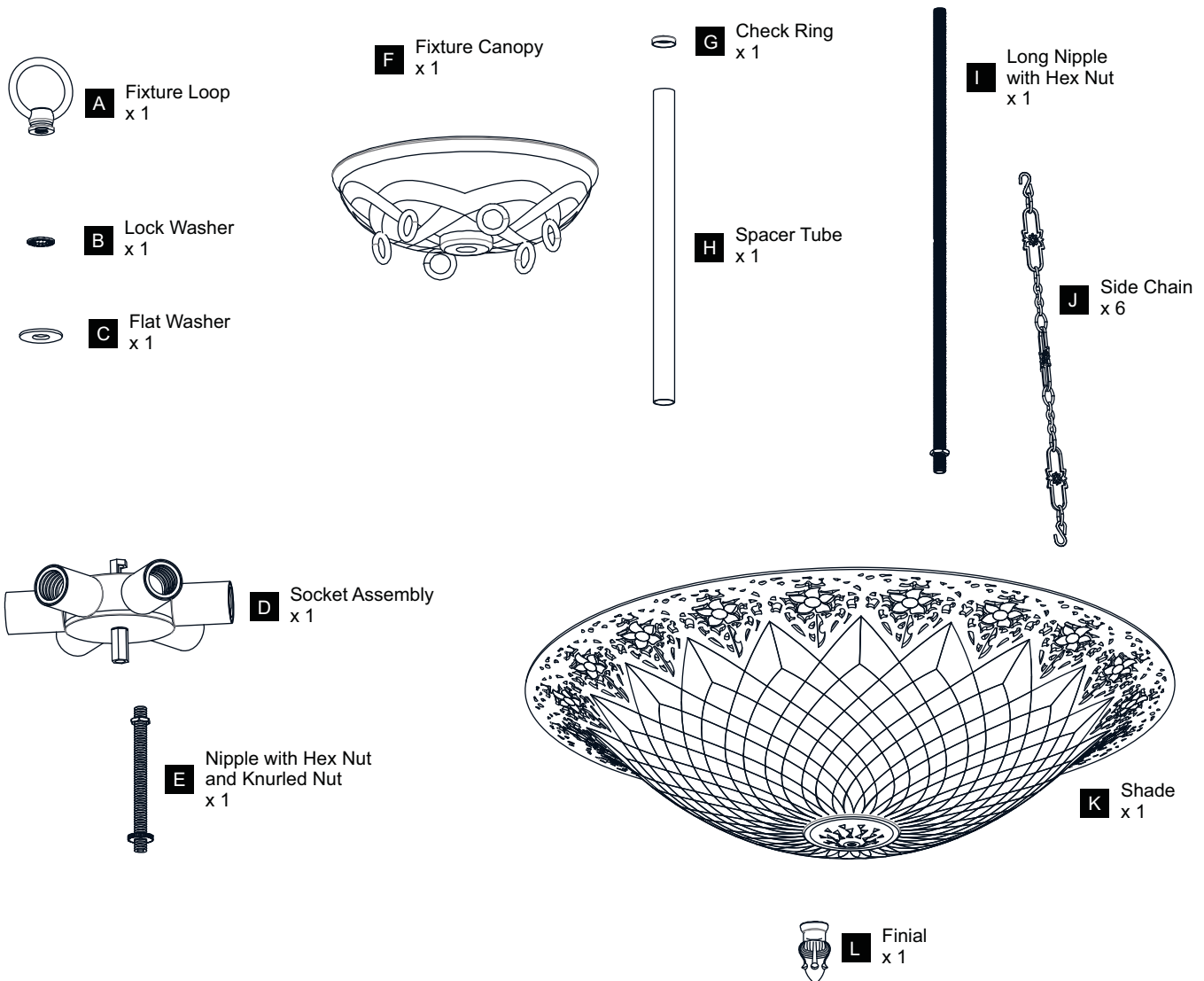

MOUNTING HARDWARE

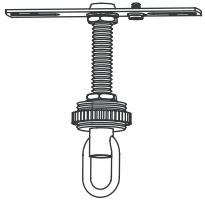

AA Crossbar Assembly
x 1

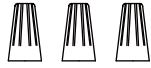

BB Wire Connector
x 3



CC Outlet Box Screw
x 2

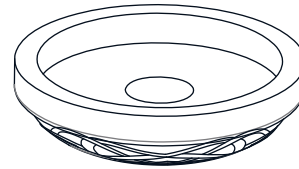

DD Ceiling Canopy
x 1

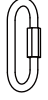

EE Quick Link
x 2



FF Fixture Chain
x 1

INSTALLATION

1 Install Long Nipple with Hex Nut

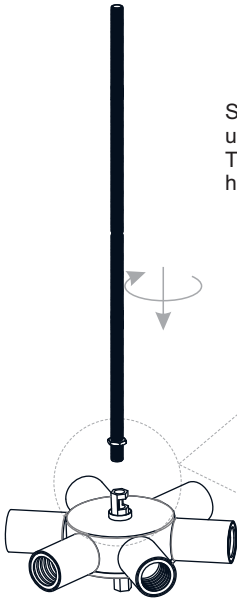

Screw the long nipple into the hickey until it is against the nipple inside. Then thread the hex nut against the hickey and hand tighten until snug.

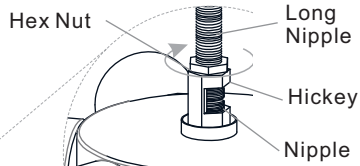

2 Install Spacer Tube, Check Ring, Fixture Canopy and Fixture Loop

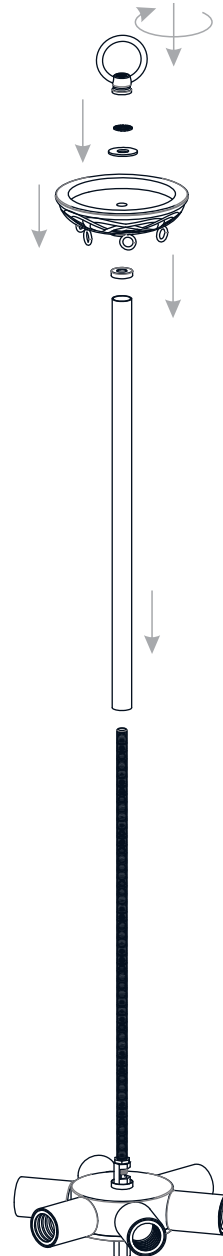

3 Install Crossbar Assembly

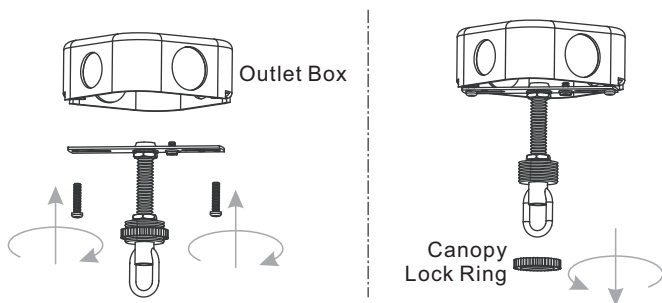

4 Install Fixture Chain

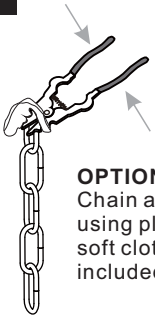

OPTIONAL: Adjust Chain as desired, using pliers and soft cloth (neither included).

Suggested chain length for Ceiling height:
 8 feet ceiling: use 5 links of chain and 2 quick links
 9 feet ceiling: use 15 links of chain and 2 quick links
 10 feet ceiling: use 25 links of chain and 2 quick links.

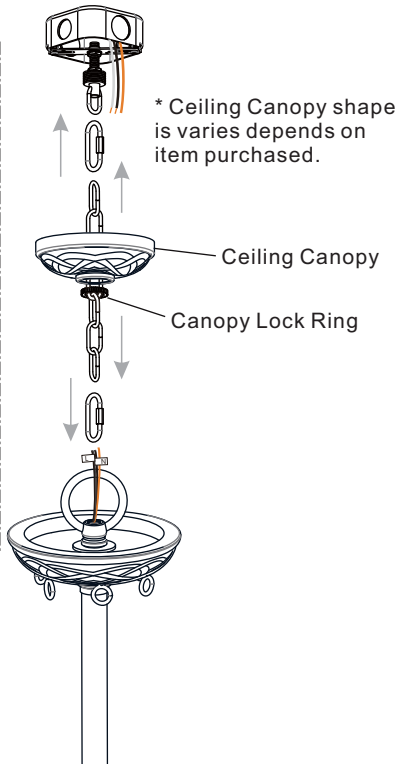

5 Pull Supply Wires

Pull the supply wires with ground wire through the chain alternate links.

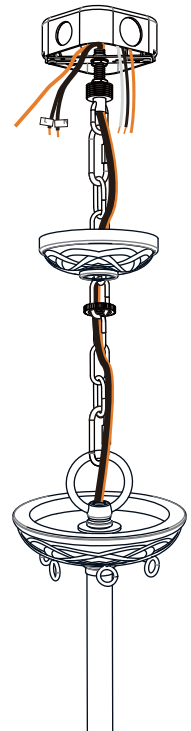

6 Wiring

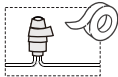

White wire from supply Ribbed side of wire from fixture identified with the label "N"

Black (or red) wire from supply Smooth side of wire from fixture identified with the label "L"

Ground wire from supply Ground wire from fixture identified with the label "G"

Green ground wire

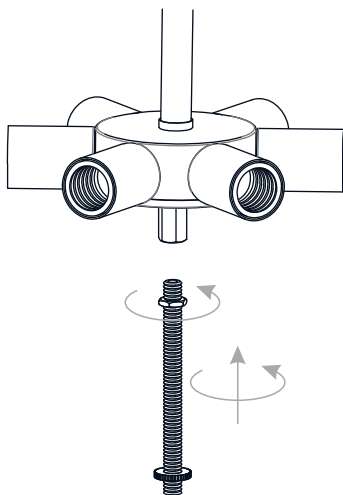

7 Install Ceiling Canopy

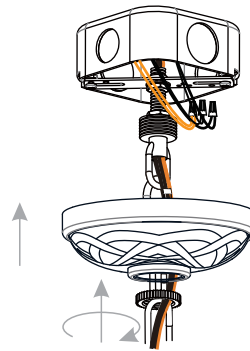

* Ceiling Canopy shape is varies depends on item purchased.

8 Install Nipple with Hex Nut and Knurled Nut

9 Install Shade

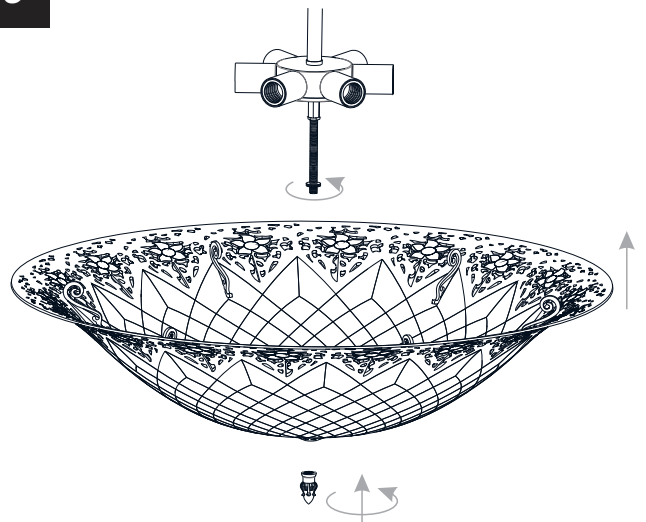

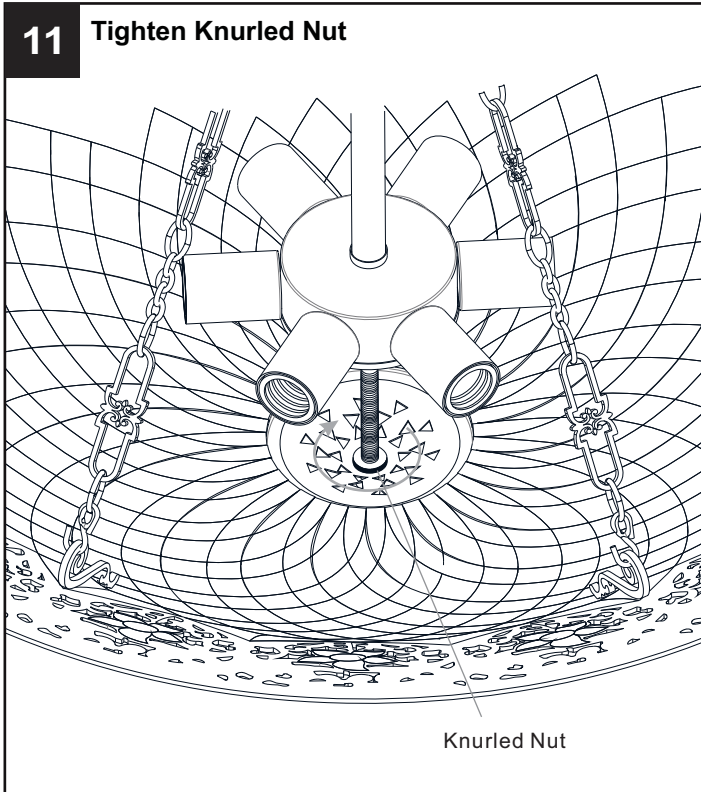
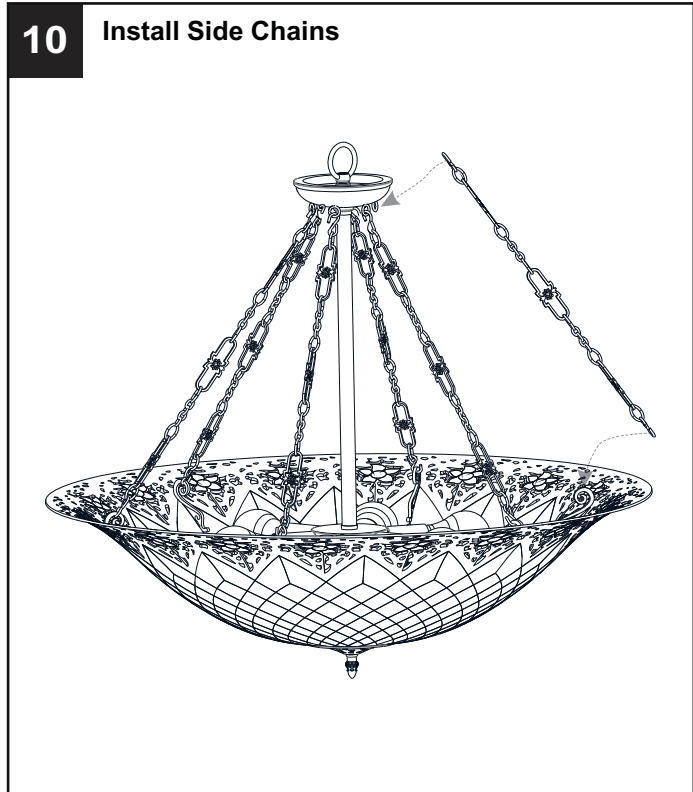



12 Install Bulbs

Install six correct bulbs referring to fixture markings and/or labels for maximum wattage.

Recommended Bulb Type (not included):

	
BULB BASE TYPE Medium (E26)	BULB TYPE TYPE A

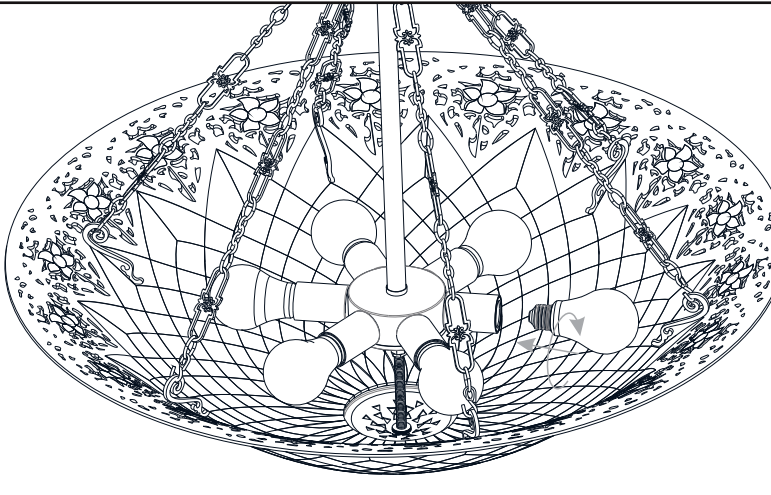

Your installation is now complete! Restore electricity and save this sheet for future reference.