

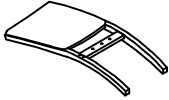

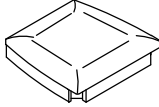

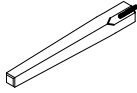

# ASSEMBLY INSTRUCTION

## DINING CHAIR

<b>A</b> Chair Back  1 pc	<b>B</b> Seat Cushion  1 pc	<b>C</b> Front Leg  2 pcs	<b>D</b> Allen Bolt Ø5/16"x38mm  2 pcs
<b>E</b> Allen Bolt Ø5/16"x75mm  4 pcs	<b>F</b> Hex Nut Ø5/16"x12mm  4 pcs	<b>G</b> Lock Washer Ø5/16"xØ11mm  10 pcs	<b>H</b> Flat Washer Ø5/16"xØ19mm  10 pcs
<b>I</b> Allen Key 4mm  1 pc	<b>J</b> Open Wrench 12mm  1 pc		

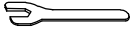
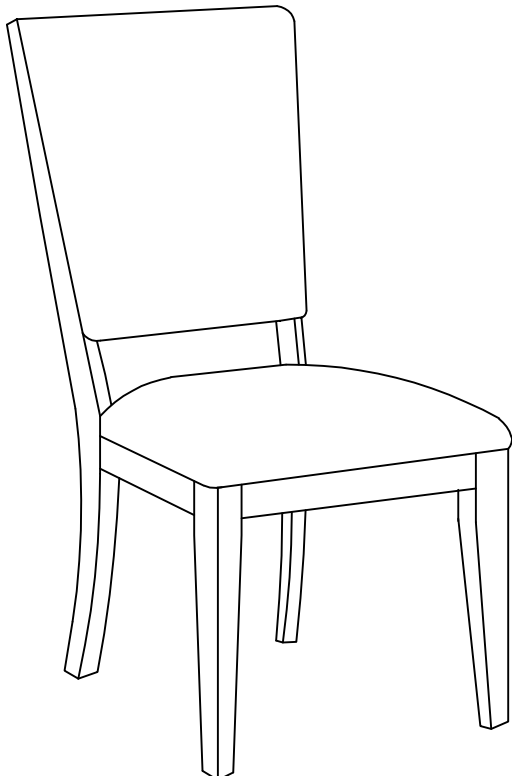

This page lists all the contents included in the box. Please take the time to identify the hardware as well as the individual components to this product. As you unpack and prepare for assembly, place the contents on a carpeted or padded area to protect them from damage.

- 1** Attach Seat Cushion (B) to Chair Back (A) by securing Flat Washer (H), Lock Washer (G), Allen Bolt (D) and Allen Key (I) onto Chair Back (A). Do not over-tighten.

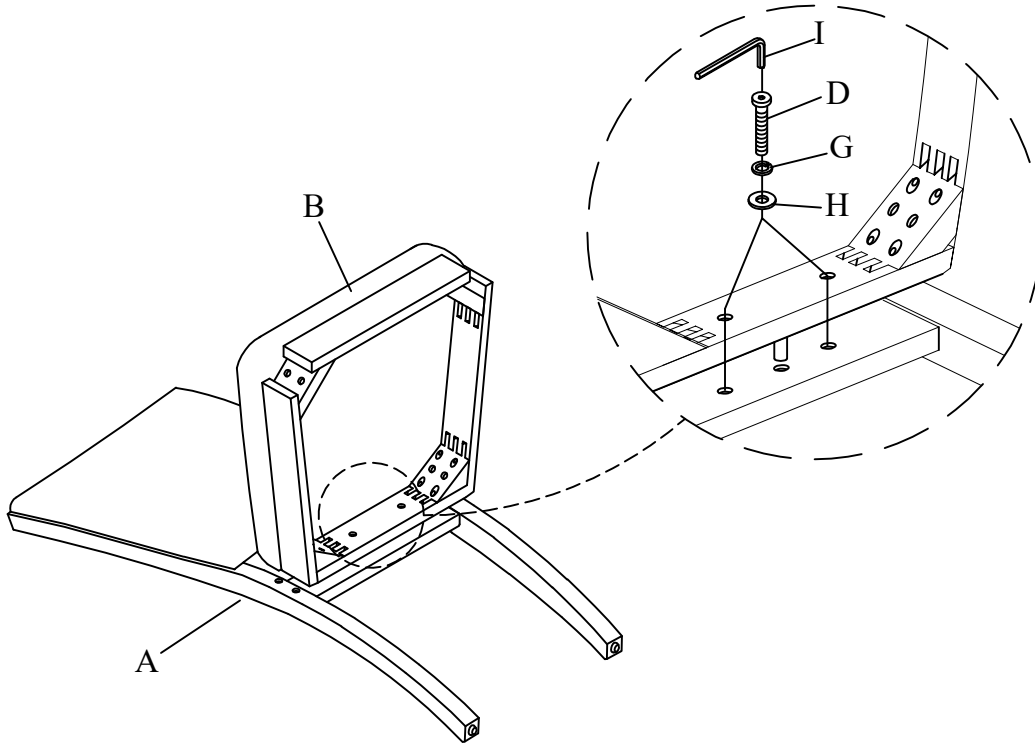

- 2** Attach Seat Cushion (B) to Chair Back (A) by securing Flat Washer (H), Lock Washer (G), Allen Bolt (E) and Allen Key (I) onto corners. Do not over-tighten.

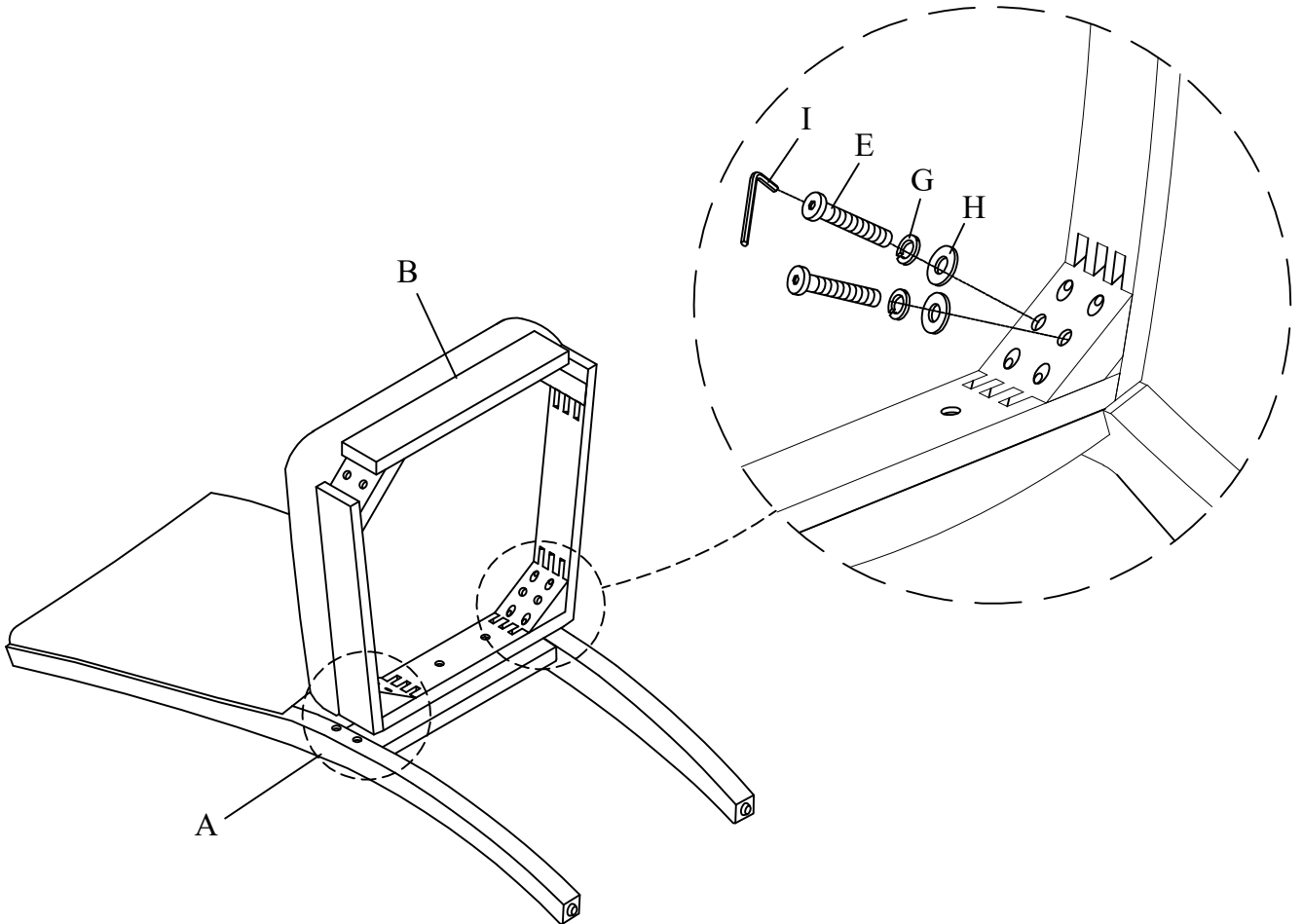

**3** Attach two Front Legs (C) to the corners of Seat Cushion (B) by using Flat Washer (H), Lock Washer (G), Hex Nut (F) and tighten with Open Wrench (J). Do not over-tighten.

Take the Open Wrench, and turn the bolts until the legs are secured. **DO NOT TIGHTEN COMPLETELY.** Stop when you feel you are adding force to tighten the bolt.

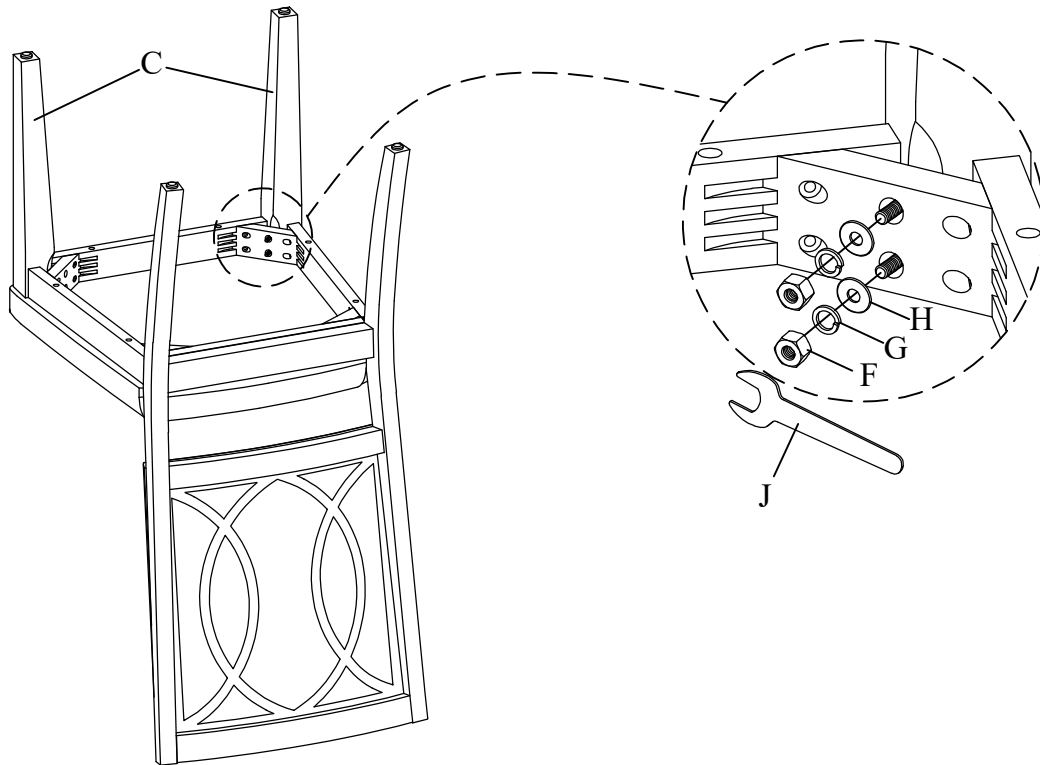

Stand chair up on an even surface and check that it is balanced. If there is a slight wobble, apply downward pressure in the corner where a leg is uneven. Keeping pressure in that corner, tighten all bolts. If balanced, apply downward pressure evenly in the center and tighten all bolts. Do not over-tighten beyond hole depth.

**Helpful Tip:**

Instead of applying downward pressure while reaching under to tighten bolts, have someone sit in the chair while you tighten the bolts.

---

**Cleaning & Care**

Treat surface with care. Surface is resistant to scratches but is not scratch resistant. Clean surfaces with a dry or damp soft cloth. Do not use abrasive cleaners. Hardware may loosen over time. Periodically check that all connections are tight.