



Specifier's Guide

Line installation and protective
equipment master catalog
5 kV - 35 kV electrical
distribution systems

EATON

Powering Business Worldwide

Education and Training

OCP and OVP CEU-Accredited Workshops



Overvoltage Protection Workshop

Learn how to economically prevent excessive transient overvoltages from damaging electric utility distribution systems equipment or interrupting normal power system operation in Eaton's two-day Overvoltage Protection Workshop. The workshop is designed for utility distribution engineers or any engineer who is involved with design or implementation of overvoltage protection schemes for utility distribution systems.

Class topics include:

- Basic overvoltage protection
- Basic Insulation Level (BIL)
- Insulation coordination
- Sources of system overvoltages
- Arrester fundamentals
- Application of arresters and other overvoltage protection schemes
- Distribution equipment protection
- Overhead and underground systems protection
- Substation transients
- Low voltage surge protection

Overcurrent Protection Workshop

Register Today!

Get hands-on experience learning how to apply overcurrent protection schemes in Eaton's two-day Distribution Overcurrent Protection Workshop. Any engineer who is involved with design or operation of overcurrent protection schemes for utilities will benefit. The workshop will be more beneficial to you if you have a working knowledge of overcurrent protection devices.

Class topics include:

System coordination rules and procedures to incorporate into your daily routine

- Fuse-to-fuse expulsion and current-limiting coordination
- Transformer fusing protection
- Protection with sectionalizers
- Recloser and source-side coordination and load-side coordination
- Exposure to CYMET™ Power Engineering Software... and many more!

Additional Details

The classes are held at our Power Systems Experience Center, 130 Commonwealth Drive, Warrendale, PA.
Contact your local Eaton representative to register today!

eaton.com/electricaltraining

Table of Contents	Page
Standard Interfaces For Separable Connectors and Components	4
Certified Tests and Performance	5
Conductor Sizing	6
AEIC Insulation Diameter Chart	8
ICEA Insulation Diameter Chart	9
200 A Loadbreak Connectors	10
200 A Deadbreak Connectors	12
200 A Stacking Dimensions	16
Cleer 600 A Loadbreak Connectors	18
600/900 A Deadbreak Connectors	22
600/900 A Components and Replacement Parts	24
600/900 A Connector Systems	26
600 A Stacking Dimensions	28
Junction Bars/Cable Transition and Oil Stop Modules	30
Splices	36
Underground Surge Arresters	38
Tools & Maintenance	40
Bushings	44
Fusing	46
MagneX Single-Phase Interrupter	48
MagneX Three-Phase Interrupter	50
Faulted Circuit Indicators	52
Sectionalizing Cabinets	56
Part Number Index	62
Energizing a World that Demands More	64
Product Application Overhead and Underground Distribution Systems	66

Standard interfaces for separable connectors and components

The following diagram specifies the IEEE Std 386™ standard interfaces supplied by Eaton for various applications to ensure interchangeability of any mating components.

Interface Description Per IEEE Std 386™ standard

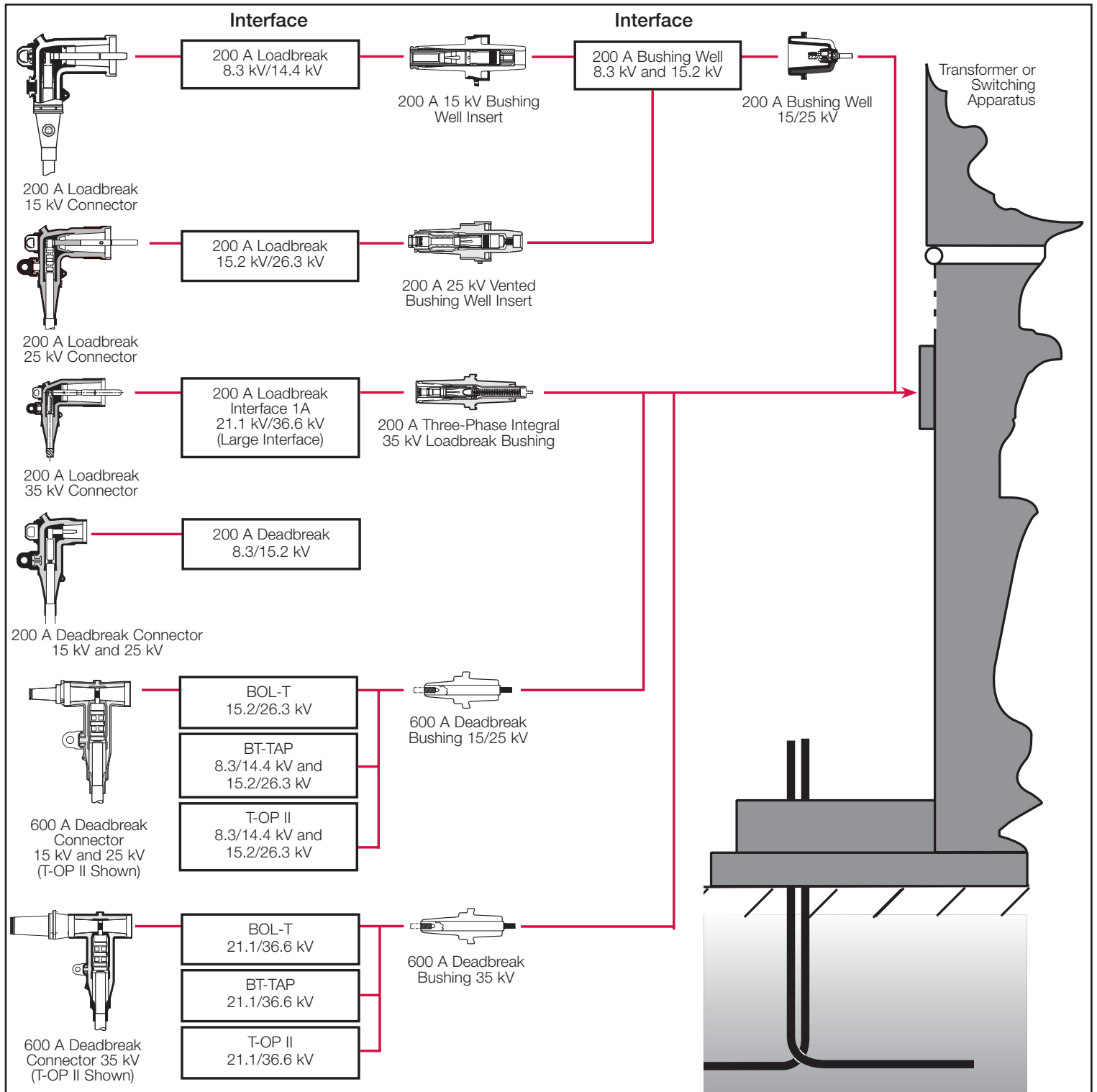

Eaton's Cooper Power series Connectors, Splices, Underground Surge Arresters, Tools, Bushings, Fusing, Faulted Circuit Indicators and Sectionalizing Equipment have been designed and tested per applicable portions of Institute of Electrical and Electronics Engineers, Inc. (IEEE®), American National Standards Institute (ANSI®), National Electrical Manufacturers Association (NEMA) and other industry standards including:

- **IEEE Std 386™** standard for Separable Connectors
- **IEEE Std 404™** standard for Cable Joints and Splices
- **IEEE Std C62.11™** standard for Metal Oxide Surge Arresters
- **IEEE Std C37.41™** standard for Current-Limiting Fuses
- **IEEE Std 592™** standard for Exposed Semi-conducting Shields
- **ANSI C119.4 Standard** for Copper and Aluminum Conductor Connectors
- **AEIC CS5, CS6 and CS8 Standards** for XLP and EPR Insulated Cables
- **ICEA S-94-649 Standard** for XLP and EPR Insulated Cables

Eaton rates its Cooper Power series Separable Connectors for 15 kV, 25 kV and 35 kV systems in accordance with the following ratings.

Splice Voltage Ratings in Accordance with IEEE Std 404™ standard

Voltage Ratings and Characteristics			
Description	Voltage		
Standard Voltage Class (kV)	15	25	35
Maximum Rating Phase-to-Ground (kV rms)	8.7	14.4	20.2
AC 60 Hz 1 Minute Withstand (kV rms)	35	52	69
DC 15 Minute Withstand (kV)	70	100	125
BIL and Full Wave Crest (kV peak)	110	150	200
Minimum Corona Voltage Level (kV)	13	22	31

Splice Current Ratings in Accordance with IEEE Std 404™ standard

Current Ratings and Characteristics	
Description	Amperes
Continuous	Equal to the current rating of the cable per IEEE Std 404™ standard
Short Time	Equal to the current rating of the cable per IEEE Std 404™ standard

200 A Loadbreak Connector Ratings in Accordance with IEEE Std 386™ standard

Voltage Ratings	15 kV	25 kV	35 kV
Standard Voltage Class	15	25	35
Maximum Rating Phase-to-Phase	14.4	26.3	36.6
Maximum Rating Phase-to-Ground	8.3	15.2	21.1
AC 60 Hz 1 Minute Withstand	34	40	50
DC 15 Minute Withstand	53	78	103
BIL and Full Wave Crest	95	125	150
Minimum Corona Voltage Level	11	19	26
Current Ratings	15 kV	25 kV	35 kV
Continuous	200 A rms	200 A rms	200 A rms
Switching	10 make/break operations at 200 A rms at 14.4 kV	10 make/break operations at 200 A rms at 26.3 kV	10 make/break operations at 200 A rms at 36.6 kV
Fault Closure	10,000 A rms sym. at 14.4 kV for 0.17s after 10 switching operations	10,000 A rms sym. at 26.3 kV for 0.17s after 10 switching operations	10,000 A rms sym. at 36.6 kV for 0.17s after 10 switching operations
Short Time	10,000 A rms sym. for 0.17s 3,500 A rms sym. for 3.0s	10,000 A rms sym. for 0.17s 3,500 A rms sym. for 3.0s	10,000 A rms sym. for 0.17s 3,500 A rms sym. for 3.0s

600 A Deadbreak Connector Ratings in Accordance with IEEE Std. 386™ standard

Voltage Ratings	15 kV	25 kV	35 kV
Standard Voltage Class	25	25	35
Maximum Rating Phase-to-Ground	15.2	15.2***	21.1
AC 60 Hz 1 Minute Withstand	40	40	50
DC 15 Minute Withstand	78	78	103
BIL and Full Wave Crest	125	125	150
Minimum Corona Voltage Level	19	19	26
Current Ratings	15 kV	25 kV	35 kV
600 A Interface**			
Continuous	600 A rms	600 A rms	600 A rms
24 Hour Overload	1,000 A rms	1,000 A rms	1,000 A rms
Short Time	25,000 A rms sym. for 0.17 s 10,000 A rms sym. for 3.0 s	25,000 A rms sym. for 0.17 s 10,000 A rms sym. for 3.0 s	25,000 A rms sym. for 0.17 s 10,000 A rms sym. for 3.0 s
200 A Interface On Loadbreak Reducing Tap Plug (LRTP)*			
Continuous	200 A rms	200 A rms	200 A rms
Switching	10 make/break operations at 200 A rms at 14.4 kV	10 make/break operations at 200 A rms at 26.3 kV	10 make/break operations at 200 A rms at 36.6 kV
Fault Closure	10,000 A rms sym. at 14.4 kV for 0.17s after 10 switching operations	10,000 A rms sym. at 26.3 kV for 0.17s after 10 switching operations	10,000 A rms sym. at 36.6 kV for 0.17s after 10 switching operations
Short Time	10,000 A rms sym. for 0.17 s 3,500 A rms sym. for 3.0s	10,000 A rms sym. for 0.17 s 3,500 A rms sym. for 3.0s	10,000 A rms sym. for 0.17 s 3,500 A rms sym. for 3.0s

Notes:

- * System design and protection must recognize the ratings of 200 A interface.
- ** Optional 900 A rating is available. Refer to 600/900 A Deadbreak Connector section for more detail.
- *** 25 kV insulating plugs and standoff bushings are rated 16.2 kV phase-to-ground.

Conductor sizing

Part Number Selection Process for Cable Sensitive Products

Eaton designs its Cooper Power series 200 A and 600 A connector products for applications on XLPE, EPR or other solid dielectric insulated underground electrical cables. In order to maintain a reliable termination, the cable accessories must be sized correctly with the cable conductor size and cable insulation diameter.

The cable conductor size is used to determine the compression connector used. Proper sizing is important to ensure reliable current transfer from the underground cable conductor to the elbow connector. Conductor diameters are dependent on the conductor size in AWG or kcmil, and conductor type (stranded, compressed, compact or solid).

The cable insulation diameter (the diameter over the insulation) is critical because it is important to maintain a tightly sealed fit between the cable insulation and the elbow housing at the cable entrance. As the insulation thickness changes, so must the range of the cable accessory. Cable insulation diameter can be determined from the cable manufacturer's specification, or by referring to pages 8 (for cable made to the AEIC Standard including the ± 0.030 inch tolerance) or 9 (for cable made to the ICEA Standard) for minimum and maximum diameters.

EXAMPLE: PROPER ELBOW PART NUMBER SELECTION

Select an Eaton's Cooper Power series 15 kV 200 A Loadbreak Elbow with optional integral jacket seal and test point for an AEIC standard tape-shielded 15 kV cable with 133% insulation and 1/0 compact stranded conductor with an outer jacket diameter of 1.07".

Step 1 – Base Part Number Selection

Select base part number of **LEJ215** from page 11 for 15 kV voltage class. Note that on page 11 reference is also made to tables CR1 and CC1.

Step 2 – Determine Insulation Outside Diameter Range

Since cable is made to AEIC Standards, refer to page 8. 133% 15 kV cable corresponds to 220 mil insulation wall thickness. The AEIC table gives a range of 0.805" to 0.865" for 1/0 compact 220 mil cable.

Step 3 – Elbow Cable Range Selection

Refer to CR1 Table on page 13 and select a cable range code of "**AB**" with a range of 0.610" to 0.970" to cover 0.805" to 0.865".

LEJ215

CABLE RANGE
CODE (CR1)

Step 4 – Elbow Connector Selection

Refer to CC1 Table on page 13 and select a conductor code of "**05**" which applies to the specified 1/0 compact conductor.

LEJ215

AB

CONDUCTOR
CODE (CC1)

Step 5 – Optional Test Point Selection

In accordance with Note 1 on page 11, for an elbow with test point, add a "**T**" after the cable range and conductor code.

LEJ215

AB

05

T

Step 6 – Optional Ground Strap

Tape-shielded cable requires a ground strap and bleeder wire to terminate. Add "GS" after test point option.

LEJ215

AB

05

TGS

Step 7 – Ordering

Therefore, order part number

LEJ215AB05TGS

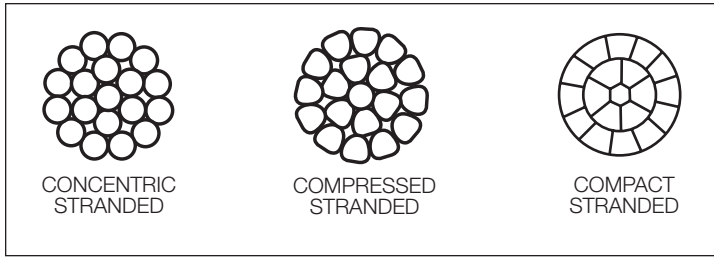

Types of Stranded Conductor

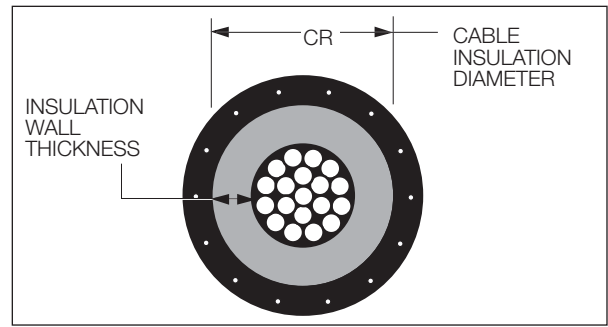

Cable insulation

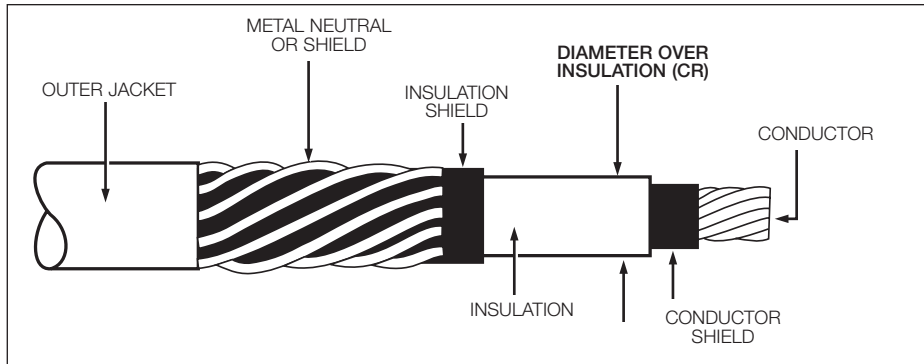

Illustration showing typical construction of medium voltage underground cable.

Cable Conductor Reference

Conductor Size AWG or kcmil	No. of Strands and their Nom. Strand Dia. (in.)	Cross-sectional Area		Stranded Conductors (inches)	Compressed Conductors (inches)	Compact Conductors (inches)	Solid Conductors (inches)
		Square Inches	mm ² Conversion				
14	7 x 0.0242	0.0032	2.08	0.073	-	-	0.064
12	7 x 0.0305	0.0051	3.31	0.092	-	-	0.081
10	7 x 0.0385	0.0082	5.26	0.116	-	-	0.102
8	7 x 0.0486	0.0130	8.37	0.146	-	-	0.129
6	7 x 0.0612	0.0206	13.30	0.184	-	-	0.162
4	7 x 0.0772	0.0328	21.15	0.232	-	-	0.204
2	7 x 0.0974	0.0521	33.62	0.292	0.283	0.268	0.258
1	19 x 0.0664	0.0657	42.41	0.332	0.322	0.299	0.289
1/0	19 x 0.0745	0.0829	53.49	0.373	0.362	0.336	0.325
2/0	19 x 0.0837	0.1045	67.43	0.418	0.405	0.376	-
3/0	19 x 0.0940	0.1318	85.01	0.470	0.456	0.423	-
4/0	19 x 0.1055	0.1662	107.2	0.528	0.512	0.475	-
250	37 x 0.0822	0.1964	127	0.575	0.558	0.520	-
350	37 x 0.0973	0.2749	177	0.681	0.661	0.616	-
500	37 x 0.1162	0.3927	253	0.813	0.789	0.736	-
600	61 x 0.0992	0.4712	304	0.893	0.866	0.813	-
700	61 x 0.1071	0.5498	355	0.964	0.935	0.877	-
750	61 x 0.1109	0.5891	380	0.998	0.968	0.908	-
800	61 x 0.1145	0.6283	405	1.031	1.000	0.938	-
900	61 x 0.1215	0.7069	456	1.094	1.061	0.999	-
1000	61 x 0.1280	0.7854	507	1.152	1.117	1.060	-

AEIC insulation diameter chart

Cable Insulation Diameters for Standard AEIC Cables with 175, 220, 260, and 345 mil Insulation Wall Thickness

Insulation AWG or kcmil	Wall Thickness* (Inches)	Voltage Class kV	Concentric Stranded		Compressed Stranded		Compact Stranded		Solid	
			Min. Dia. (inches)	Max. Dia. (inches)	Min. Dia. (inches)	Max. Dia. (inches)	Min. Dia. (inches)	Max. Dia. (inches)	Min. Dia. (inches)	Max. Dia. (inches)
#2	.175	15	0.670	0.730	0.665	0.725	0.650	0.710	0.640	0.700
	.220	15	0.760	0.820	0.775	0.815	0.740	0.800	0.730	0.790
	.260	25	—	—	—	—	—	—	—	—
	.345	35	—	—	—	—	—	—	—	—
#1	.175	15	0.710	0.770	0.700	0.760	0.680	0.740	0.670	0.730
	.220	15	0.800	0.860	0.790	0.850	0.770	0.830	0.760	0.820
	.260	25	0.880	0.940	0.870	0.930	0.850	0.910	0.840	0.900
	.345	35	—	—	—	—	—	—	—	—
1/0	.175	15	0.755	0.815	0.740	0.800	0.715	0.775	0.705	0.765
	.220	15	0.845	0.905	0.830	0.890	0.805	0.865	0.795	0.855
	.260	25	0.925	0.985	0.910	0.970	0.885	0.945	0.875	0.935
	.345	35	1.095	1.155	1.080	1.140	1.055	1.115	1.045	1.105
2/0	.175	15	0.800	0.860	0.785	0.845	0.755	0.815	0.805	0.905
	.220	15	0.890	0.950	0.875	0.935	0.845	0.905	0.835	0.895
	.260	25	0.970	1.030	0.955	1.015	0.925	0.985	0.915	0.975
	.345	35	1.140	1.200	1.125	1.185	1.095	1.155	1.085	1.145
3/0	.175	15	0.850	0.910	0.835	0.895	0.805	0.865	0.850	0.940
	.220	15	0.940	1.000	0.925	0.985	0.895	0.955	0.880	0.940
	.260	25	1.020	1.080	1.005	1.065	0.975	1.035	0.960	1.020
	.345	35	1.190	1.250	1.175	1.235	1.145	1.205	1.130	1.190
4/0	.175	15	0.910	0.970	0.890	0.950	0.855	0.915	0.900	0.990
	.220	15	1.000	1.060	0.980	1.040	0.945	1.005	0.930	0.990
	.260	25	1.080	1.140	1.060	1.120	1.025	1.085	1.010	1.070
	.345	35	1.250	1.310	1.230	1.290	1.195	1.255	1.180	1.240
250	.175	15	0.965	1.025	0.950	1.010	0.910	0.970	—	—
	.220	15	1.055	1.115	1.040	1.100	1.000	1.060	—	—
	.260	25	1.145	1.205	1.130	1.190	1.095	1.150	—	—
	.345	35	1.320	1.380	1.305	1.365	1.265	1.325	—	—
350	.175	15	1.070	1.130	1.050	1.110	1.005	1.065	—	—
	.220	15	1.160	1.220	1.140	1.200	1.095	1.155	—	—
	.260	25	1.250	1.310	1.230	1.290	1.185	1.245	—	—
	.345	35	1.425	1.485	1.405	1.465	1.360	1.420	—	—
500	.175	15	1.205	1.265	1.180	1.240	1.125	1.185	—	—
	.220	15	1.295	1.355	1.270	1.330	1.215	1.275	—	—
	.260	25	1.385	1.445	1.360	1.420	1.305	1.365	—	—
	.345	35	1.560	1.620	1.535	1.595	1.480	1.540	—	—
600	.175	15	1.295	1.355	1.265	1.325	1.215	1.275	—	—
	.220	15	1.385	1.445	1.355	1.415	1.305	1.365	—	—
	.260	25	1.475	1.535	1.445	1.505	1.395	1.455	—	—
	.345	35	1.650	1.710	1.625	1.680	1.570	1.630	—	—
700	.175	15	1.365	1.425	1.335	1.395	1.275	1.335	—	—
	.220	15	1.455	1.515	1.425	1.485	1.365	1.425	—	—
	.260	25	1.545	1.605	1.515	1.575	1.455	1.515	—	—
	.345	35	1.720	1.780	1.690	1.750	1.630	1.690	—	—
750	.175	15	1.400	1.460	1.370	1.430	1.310	1.370	—	—
	.220	15	1.490	1.550	1.460	1.520	1.400	1.460	—	—
	.260	25	1.580	1.640	1.550	1.610	1.490	1.550	—	—
	.345	35	1.755	1.815	1.725	1.785	1.665	1.725	—	—
800	.175	15	1.430	1.490	1.400	1.460	1.340	1.400	—	—
	.220	15	1.520	1.580	1.490	1.550	1.430	1.490	—	—
	.260	25	1.610	1.670	1.580	1.640	1.520	1.580	—	—
	.345	35	1.785	1.845	1.755	1.815	1.695	1.755	—	—
900	.175	15	1.495	1.555	1.460	1.520	1.400	1.460	—	—
	.220	15	1.585	1.645	1.550	1.610	1.490	1.550	—	—
	.260	25	1.675	1.735	1.640	1.700	1.580	1.640	—	—
	.345	35	1.850	1.910	1.815	1.875	1.755	1.815	—	—
1000	.175	15	1.550	1.610	1.515	1.575	1.460	1.520	—	—
	.220	15	1.640	1.700	1.605	1.665	1.550	1.610	—	—
	.260	25	1.730	1.790	1.695	1.755	1.640	1.700	—	—
	.345	35	1.850	1.955	1.815	1.920	1.760	1.865	—	—

* See table below for standard insulation thickness.

175 mil is 100% insulated cable at 15 kV.
 220 mil is 133% insulated cable at 15 kV.
 260 mil is 100% insulated cable at 25 kV.
 345 mil is 133% insulated cable at 25 kV.
 345 mil is 100% insulated cable at 35 kV.

ICEA insulation diameter chart

Cable Insulation Diameters for Standard ICEA Cables with 175, 220, 260, and 345 mil Insulation Wall Thickness

AWG or kcmil	Insulation Wall Thickness* (Inches)	Voltage Class kV	Concentric Stranded		Compressed Stranded		Compact Stranded		Solid	
			Min. Dia. (inches)	Max. Dia. (inches)	Min. Dia. (inches)	Max. Dia. (inches)	Min. Dia. (inches)	Max. Dia. (inches)	Min. Dia. (inches)	Max. Dia. (inches)
#2	.175	15	0.645	0.730	0.635	0.720	0.620	0.705	0.610	0.695
	.220	15	0.735	0.825	0.725	0.815	0.710	0.800	0.700	0.790
	.260	25	-	-	-	-	-	-	-	-
	.345	35	-	-	-	-	-	-	-	-
#1	.175	15	0.685	0.770	0.675	0.760	0.655	0.735	0.645	0.725
	.220	15	0.775	0.865	0.765	0.855	0.745	0.830	0.735	0.820
	.260	25	0.845	0.935	0.835	0.925	0.815	0.905	0.805	0.895
	.345	35	-	-	-	-	-	-	-	-
1/0	.175	15	0.725	0.810	0.715	0.800	0.690	0.775	0.680	0.760
	.220	15	0.815	0.905	0.805	0.895	0.780	0.865	0.770	0.855
	.260	25	0.885	0.980	0.875	0.965	0.850	0.940	0.835	0.925
	.345	35	1.055	1.155	1.045	1.145	1.020	1.120	1.010	1.110
2/0	.175	15	0.775	0.855	0.760	0.845	0.730	0.815	0.715	0.800
	.220	15	0.865	0.950	0.850	0.935	0.820	0.905	0.805	0.895
	.260	25	0.935	1.025	0.920	1.010	0.890	0.980	0.875	0.965
	.345	35	1.105	1.200	1.090	1.190	1.060	1.160	1.045	1.145
3/0	.175	15	0.825	0.905	0.810	0.895	0.775	0.860	0.765	0.845
	.220	15	0.915	1.000	0.900	0.985	0.865	0.955	0.855	0.940
	.260	25	0.985	1.075	0.970	1.060	0.935	1.030	0.925	1.015
	.345	35	1.155	1.255	1.140	1.240	1.105	1.205	1.095	1.195
4/0	.175	15	0.880	0.965	0.865	0.950	0.830	0.910	0.815	0.895
	.220	15	0.970	1.060	0.955	1.045	0.920	1.005	0.905	0.990
	.260	25	1.040	1.135	1.025	1.115	0.990	1.080	0.975	1.065
	.345	35	1.210	1.310	1.195	1.295	1.160	1.260	1.145	1.245
250	.175	15	0.935	1.020	0.920	1.005	0.880	0.965	-	-
	.220	15	1.025	1.115	1.010	1.100	0.970	1.060	-	-
	.260	25	1.095	1.190	1.080	1.175	1.040	1.135	-	-
	.345	35	1.265	1.370	1.250	1.350	1.210	1.315	-	-
350	.175	15	1.045	1.130	1.025	1.110	0.980	1.065	-	-
	.220	15	1.135	1.220	1.115	1.200	1.070	1.155	-	-
	.260	25	1.205	1.295	1.185	1.275	1.140	1.230	-	-
	.345	35	1.375	1.475	1.355	1.455	1.310	1.410	-	-
500	.175	15	1.175	1.260	1.150	1.235	1.100	1.185	-	-
	.220	15	1.265	1.355	1.240	1.330	1.190	1.275	-	-
	.260	25	1.335	1.430	1.310	1.405	1.260	1.350	-	-
	.345	35	1.505	1.605	1.480	1.580	1.430	1.530	-	-
600	.175	15	1.265	1.350	1.235	1.325	1.185	1.270	-	-
	.220	15	1.355	1.445	1.325	1.415	1.275	1.365	-	-
	.260	25	1.425	1.520	1.395	1.490	1.345	1.440	-	-
	.345	35	1.595	1.695	1.565	1.670	1.515	1.615	-	-
700	.175	15	1.335	1.420	1.305	1.390	1.245	1.335	-	-
	.220	15	1.425	1.515	1.395	1.485	1.335	1.430	-	-
	.260	25	1.495	1.590	1.465	1.560	1.405	1.500	-	-
	.345	35	1.665	1.765	1.635	1.740	1.575	1.680	-	-
750	.175	15	1.370	1.455	1.340	1.425	1.280	1.365	-	-
	.220	15	1.460	1.550	1.430	1.520	1.370	1.460	-	-
	.260	25	1.530	1.625	1.500	1.595	1.440	1.535	-	-
	.345	35	1.700	1.800	1.670	1.770	1.610	1.710	-	-
800	.175	15	1.400	1.490	1.370	1.455	1.310	1.395	-	-
	.220	15	1.490	1.580	1.460	1.550	1.400	1.490	-	-
	.260	25	1.560	1.655	1.530	1.625	1.470	1.565	-	-
	.345	35	1.730	1.835	1.700	1.805	1.640	1.740	-	-
900	.175	15	1.465	1.550	1.430	1.520	1.370	1.455	-	-
	.220	15	1.555	1.645	1.520	1.610	1.460	1.550	-	-
	.260	25	1.625	1.720	1.590	1.685	1.530	1.625	-	-
	.345	35	1.795	1.895	1.760	1.865	1.700	1.800	-	-
1000	.175	15	1.520	1.610	1.485	1.575	1.430	1.515	-	-
	.220	15	1.610	1.705	1.575	1.670	1.520	1.610	-	-
	.260	25	1.680	1.775	1.645	1.740	1.590	1.685	-	-
	.345	35	1.850	1.955	1.815	1.920	1.760	1.865	-	-

* See table below for standard insulation thickness.

175 mil is 100% insulated cable at 15 kV.
 220 mil is 133% insulated cable at 15 kV.
 260 mil is 100% insulated cable at 25 kV.
 345 mil is 133% insulated cable at 25 kV.
 345 mil is 100% insulated cable at 35 kV.

200 A loadbreak connectors

Eaton connects underground cable to transformers, sectionalizing cabinets and junctions with its Cooper Power series 200 A 15, 25, and 35 kV loadbreak elbow connectors and accessories which are ideal for submersible, fully-shielded and insulated plug-in terminations. These connectors are molded using high-quality, peroxide-cured EPDM insulation for reliable field performance.

15 kV and 25 kV loadbreak elbows are available with an integral jacket seal for use with concentric neutral and other types of shielded cables.

All 200 A loadbreak connectors meet the electrical, mechanical, and dimensional requirements of IEEE Std 386™ standard and are designed to be fully interchangeable with other major manufacturers currently complying with IEEE Std 386™ standard.

25 kV POSI-BREAK Elbow and Cap

Eaton increases strike distance and improves reliability with its Cooper Power series POSI-BREAK™ elbow and cap. The added features solve problems, such as:

- **Partial Vacuum Flashovers** – Under certain conditions during 25 kV switching, a partial vacuum can decrease the dielectric strength of the air inside the elbow/bushing or cap/bushing. This increases the possibility of a flashover from the elbow or cap's probe along the bushing interface to the grounded collar on the mating bushing product. The POSI-BREAK design eliminates the possibility of partial vacuum flashovers during switching because of the increased strike distance.
- **Contamination** – The field-proven interface seal prevents the ingress of moisture or contaminants. However, contamination introduced during installation or switching operations can reduce the strike distance along the interface. The increased insulation of the POSI-BREAK design counteracts the effect of contamination, increasing system reliability.

25 kV POSI-BREAK elbow and cap specification information

To capitalize on the benefits of the POSI-BREAK elbow and cap, include the following information for both the 25 kV 200 A loadbreak elbow and insulated protective cap in your specification:

- Both elbow and cap must fully comply with IEEE Std 386™ standard.
- Strike distance from energized component to ground shall be at least 5.6" at 1/2" interface separation.
- Both elbow and cap shall have an insulated probe and conductive Faraday Cage for relief of electrical stress and prevention of partial discharge.
- Semi-conductive insert shall be completely surrounded with EPDM insulating rubber.



35 kV large interface elbow bushing system*

Eaton's Cooper Power series 35 kV 200 A large interface elbow bushing system is a reliable, field proven design. This system has over 25 years of field experience while being used on large 35 kV distribution systems. Features of the large interface system include:

- Increased strike distance to provide greater reliability and overall performance.
- Reliable loadbreak switching and fault closure capability.
- Full line of large interface accessory products.

* Refer to bushing section on page 44 for more information on the bushing.

35 kV elbow and accessories specification information





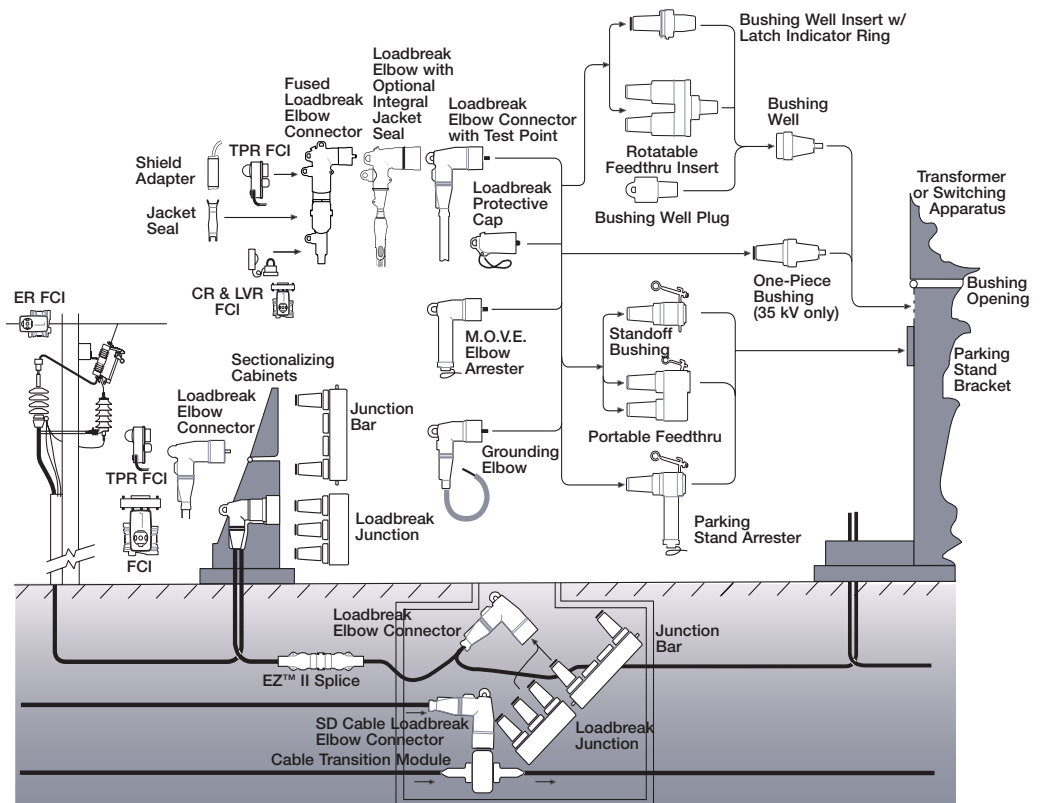













To capitalize on the benefits of our 35 kV large interface elbow include the following information in your specification:

- The 200 A elbows and accessories shall be 21.1 kV/36.6 kV three-phase rated, meeting the requirements of IEEE Std 386™ standard interface No. 1A (large 35 kV class interface).



200 A loadbreak & deadbreak connectors

- For an elbow **with test point**, add a "T" after the conductor code (CC1).
- For an elbow kit with a **hold down bail assembly** included, insert a "B" after the test point option code. 15 kV only.
- For optional braided ground strap/bleeder wire for termination tape and wire shielded cable, insert "GS" after test point and/or bail option code.
- For **individually packaged** product in a corrugated cardboard box, insert an "X" as the last character in the part number.
- To include the **SA Series Cold Shrinkable Metallic Shield Adapters Kit** or **CS Series Cold Shrink Cable Sealing Kit**, add the appropriate suffix "SA1", "SA2", "SA3", "SA4" or "CS1", "CS2", or "CS3" to the end of the loadbreak elbow catalog number. Refer to Tables CJ1 and CJ2 on Page 13.
- To order the **long version** (extended) of the **bushing insert**, put in an "L" as the seventh character in the part number.
- Specify the number of **interfaces** by inserting a "2", "3", or "4" directly after the base part number.
- To add a **stainless steel bracket**, insert a "B" as the last character in the part number, or to add **U-straps**, insert a "U" as the last character in the part number.
- To substitute a **stainless steel bracket**, insert a "S" as the last character in the part number.
- Each **CS Series Cold Shrink Cable Sealing Kit** includes:
 - Cold Shrinkable Sleeve
 - Mastic Sealing Strips
 - Installation Instructions
 For use on Concentric Neutral Cable.
- For use with tape shield, drain wire, linear corrugated and Unishield® cable.
- Each **SA Series Kit** includes:
 - Cold Shrinkable Sleeve
 - Tinned Copper Ground Strap with attached elbow drain wire
 - Constant Force Spring
 - Semi-Conductive Tape
 - Mastic Sealing Strips
 - Installation Instructions
- Probe kit includes probe, installation tool, silicone lubricant and installation instructions.
- For 200 A loadbreak inserts only.
- 5 kV cable for luse in 15 kV and 25 kV "CC" size elbow only.
- Fuses sold separately. See Table 500-110 on page 13. Reference Cat. 240-97.









Catalog Section	Description	kV Class	Base Part Number	Notes
 CA650062EN	Loadbreak Elbow	15 kV	LE215 CR1 CC1 (see CR1 & CC1 Tables Pg. 13)	1, 2, 4, 5
 CA650062EN	Loadbreak Elbow with Integral Jacket Seal	15 kV	LEJ215CR1 CC1 (see CR1 & CC1 Tables Pg. 13)	1, 2, 3, 4
 CA650098EN	Loadbreak Elbow	25 kV	LE225 CR1 CC1 (see CR1 & CC1 Tables Pg. 13)	1, 4, 5
 CA650098EN	Loadbreak Elbow with Integral Jacket Seal	25 kV	LEJ225CR1 CC1 (see CR1 & CC1 Tables Pg. 13)	1, 3, 4
 CA650100EN	POSI-BREAK Loadbreak Elbow	25 kV	PLE225 CR1 CC1 (see CR1 & CC1 Tables Pg. 13)	1, 4, 5
 CA650100EN	POSI-BREAK Loadbreak Elbow with Integral Jacket Seal	25 kV	PLEJ225CR1 CC1 (see CR1 & CC1 Tables Pg. 13)	1, 3, 4
 CA650069EN	Fused Loadbreak Elbow Connector	15 kV	LFEP215TFEC CR3 CC2 AT (see CR3 and CC2 Tables on page 13 (see Table 500-110 on page 13 for Fuse Ratings and Catalog Numbers)	16
 CA650070EN	Fused Loadbreak Elbow Connector	25 kV	LFEP225TFEC CR3 CC2 AT (see CR3 and CC2 Tables on page 13 (see Table 500-110 on page 13 for Fuse Ratings and Catalog Numbers)	16
 CA650068EN	Loadbreak Elbow	35 kV	CA650062EN CR2 CC1 (see CR2 & CC1 Tables Pg. 13)	1, 4, 5
 CA650073EN	Loadbreak Bushing Insert	15 kV	LBI215	4
 CA650074EN	Loadbreak Bushing Insert	25 kV	LBI225	4, 6
 CA650078EN and CA650077EN	Loadbreak Feedthru Insert	15 kV 25 kV	LFI215 LFI225	
 CA650072EN	Loadbreak Portable Feedthru	15 kV horizontal vertical universal	LPF215H LPF215V LPF215U	
 CA650092EN	Loadbreak Portable Feedthru	25 kV horizontal vertical universal	LPF225H LPF225V LPF225U	
 CA650015EN	Loadbreak Portable Feedthru	35 kV horizontal vertical	LPF235H LPF235V	
 CA650102EN (15kV) and CA650081EN (25kV) and CA650014EN (35kV)	Loadbreak Junction	15 kV 25 kV 35 kV	LJ215C _ LJ225C _ LJ235C _	7, 8 7, 8 7, 8
 CA650094EN	Insulated Bushing Well Plug	15/25 kV	IBWP225	
 CA650076EN	Loadbreak Protective Cap	15 kV	LPC215	4





200 A loadbreak & deadbreak connectors

200 A loadbreak & deadbreak connectors

- For **individually packaged** product in a corrugated cardboard box, insert an "X" as the last character in the part number.
- To substitute a **stainless steel bracket**, insert a "S" as the last character in the part number.
- Each **CS Series Cold Shrink Cable Sealing Kit** includes:
 - Cold Shrinkable Sleeve
 - Mastic Sealing Strips
 - Installation Instructions
 For use on Concentric Neutral Cable.
- For use with tape shield, drain wire, linear corrugated and Unishield® cable.
- Each **SA Series Kit** includes:
 - Cold Shrinkable Sleeve
 - Tinned Copper Ground Strap with attached elbow drain wire
 - Constant Force Spring
 - Semi-Conductive Tape
 - Mastic Sealing Strips
 - Installation Instructions
- Probe kit includes probe, installation tool, silicone lubricant and installation instructions.
- For 200 A loadbreak inserts only.
- 5 kV cable for use in 15 kV and 25 kV "CC" size elbow only.

(continued from previous page)

Catalog Section	Description	kV Class	Base Part Number	Notes
 CA650085EN	Loadbreak Protective Cap	25 kV	LPC225	1
 CA650083EN	POSI-BREAK Loadbreak Protective Cap	25 kV	PLPC225	1
 CA650087EN	Loadbreak Protective Cap	35 kV	LPC235	1
 CA650089EN	Insulated Standoff Bushing	15 kV	ISB215	2
 CA650004EN	Insulated Standoff Bushing	25 kV	ISB225	2
 CA650088EN	Insulated Standoff Bushing	35 kV	ISB235	2
	SA Series Cold Shrinkable Metallic Shield Adapter Kit	15/25/35 kV	SA CJ2 (see CJ2 Table Pg. 13)	4, 5
	CS Series Cold Shrink Cable Seal Kit	15/25/35 kV	CS CJ1 (see CJ1 Table Pg. 13)	3
	Coppertop Connector 200 A, 2.88" Long Bi-Metal	15/25/35 kV	CC2C CC1 T (see CC1 Table Pg. 13)	
CA650062EN and CA650098EN and CA650100EN and CA650068EN	200 A Loadbreak Probe Kit	15 kV	PK215	6
		25 kV	PK225 PKPB225 (POSI-BREAK)	6
		35 kV	PK235	6
		15/25/35 kV	2603393A03 (0.175 oz., 5 g packet) 2605670A02M (5.25 oz., 150 g tube)	

Catalog Section	Description	kV Class	Base Part Number	Notes
 CA650073EN	Installation and Torque Tool	15/25 kV	LBITOOL	7
 CA650062EN	Cable Adapter, 5 kV 0.495" - 0.585" 0.575" - 0.685"	15/25 kV	CA225A CA225B	8
				8
	U-Strap Kit with Hardware (1 strap) for Loadbreak Junction	15 kV	2625439A16B	
		25 kV	2625439A17B	
		35 kV	2637570A01B	
	2-way Stainless Steel Bracket Assembly for Loadbreak Junction	15 kV	2637172B01BS	
		25 kV	2637160B01BS	
		35 kV	2604688B01B	
	3-way Stainless Steel Bracket Assembly for Loadbreak Junction	15 kV	2637172B02BS	
		25 kV	2637160B02BS	
		35 kV	2604688B02B	
CA650102EN and CA650081EN and CA650014EN	4-way Stainless Steel Bracket Assembly for Loadbreak Junction	15 kV	2637172B03BS	
		25 kV	2637160B03BS	
		35 kV	2604688B03B	

**Use for
Base Number**

LE215
LEJ215
LE225
LEJ225
PLE225
PLEJ225

**TABLE CR1
Cable Diameter (Insulation) Range**

Cable Diameter Range		CABLE RANGE CODE
Inches	Millimeters	
0.495-0.585	12.6-14.9	CCA*
0.575-0.685	14.6-17.4	CCB*
0.610-0.970	15.5-24.6	AB
0.750-1.080	19.1-27.4	CC
0.890-1.220	22.6-30.0	DD

* Uses 5 kV cable adapter. (For use with "CC" range elbow only.)

**Use for
Base Number**

LE235

**TABLE CR2
Cable Diameter (Insulation) Range**

Cable Diameter Range		CABLE RANGE CODE
Inches	Millimeters	
0.825-1.000	21.00-25.40	B
0.995-1.180	25.20-30.00	D
1.180-1.340	30.00-34.00	F

**Use for
Base Number**

LFEP215
LFEP225

**TABLE CR3
Cable Diameter (Insulation) Range for Fused Loadbreak Elbow**

Cable Diameter Range		CABLE RANGE CODE
Inches	Millimeters	
0.610-0.820	15.5-20.8	A
0.740-0.980	18.8-24.9	B
0.910-1.180	23.10-29.9	C

**Use for
Base Number**

LE215
LEJ215
LE225
LEJ225
PLE225
PLEJ225
LE235
CC2C

**TABLE CC1
Conductor Size and Type**

Concentric or Compressed		Compact or Solid		CONDUCTOR CODE
AWG	mm ²	AWG	mm ²	
No Connector				00
#6	16	#4	-	01
#4	-	#3	25	02
#3	25	#2	35	03
#2	35	#1	-	04
#1	-	1/0	50	05
1/0	50	2/0	70	06
2/0	50	3/0	-	07
3/0	-	4/0	95	08
4/0	95	250	120	09
250*	120	300	-	10

* Compressed stranding only.

**Use for
Base Number**

CS

**TABLE CJ1
Jacketed Concentric Neutral Cable**

Minimum Seal Diameter Inches	Maximum Installed Diameter (Inches)	CODE
0.950	1.94	1
1.28	2.67	2
1.60	3.50	3

**Use for
Base Number**

SA

**TABLE CJ2
Cable Jacket (Outside Diameter) Range**

Cable Jacket OD (Inches)	JACKET CODE
0.590-1.050	1
0.830-1.640	2
1.270-2.170	3
1.600-2.600	4

**Use for
Base Number**

LFEP215
LFEP225
FECC

**TABLE CC2
Conductor Size and Type for Fused Loadbreak Elbow**

Class B Stranded or Compressed		Compact or Solid		CONDUCTOR CODE
AWG	mm ²	AWG	mm ²	
No Connector				00
		#2	35	03
#2	35	#1	-	04
#1	-	1/0	50	05
1/0	50	2/0	70	06
2/0	70	3/0	-	07
3/0	-	4/0	95	08
4/0	95	-	-	09
250*	120	-	-	10

* Compressed stranding only.

Note: Coppertop compression connector may be used on both aluminum and copper cable conductors.











Table 500-110: Fused Loadbreak Elbow Connector Fuse Electrical Ratings and Catalog Numbers (see Catalog CA650069EN and CA650070EN)

Nominal System Voltage Class - kV	Nominal Fuse Voltage Rating kV	Nominal Fuse Current rating in Amperes	Fuse Catalog Number	Maximum Continuous Current			Minimum Melt I ² t (A ² s)	Maximum Total I ² t (A ² s)
				25° C	40° C	65° C		
15.5	8.3	6	FEF083A006	8.9	8.5	8.0	710	3,800
		8	FEF083A008	12.1	11.7	10.9	1,000	5,425
		10	FEF083A010	15.0	14.4	13.5	1,200	5,825
		12	FEF083A012	16.6	16.0	15.0	1,200	5,825
		18	FEF083A018	21.9	21.1	19.7	1,500	8,000
		20	FEF083A020	25.5	24.6	23.0	2,425	12,000
		25	FEF083A025	34.5	33.2	31.1	4,500	20,500
		30	FEF083A030	40.1	38.7	36.2	6,000	26,200
25	15.5	40	FEF083A040	45.5	43.8	41.0	9,700	39,750
		6	FEF155A006	8.3	8.5	8.0	710	3,800
		8	FEF155A008	11.3	11.7	10.9	1,000	5,435
		10	FEF155A010	13.9	14.4	13.5	1,200	5,500
		12	FEF155A012	15.5	16.0	15.0	1,200	5,500
		18	FEF155A018	20.4	21.1	19.7	1,500	7,800
		20	FEF155A020	23.7	24.6	23.0	2,425	12,000

Note: Peak arc voltage levels found during testing were within the values specified for Distribution-Class Current-Limiting Fuses in ANSI® C37.47 Standard - latest edition.

200 A loadbreak & deadbreak connectors

1. Bail assembly included in kit.
2. Bail assembly is ordered separately.
3. See following for appropriate junction strap. For DJ250-2 order quantity 2 of 2639524B01. For DJ250-T2, order quantity 1 of 2638617C01.

Catalog Section	Description	kV Class	Base Part Number	Notes
 CA650048EN	Deadbreak Elbow	15/25 kV	DE225 CR4 CC3 T (see CR4 & CC3 Tables, page 15)	1
 CA650045EN	Deadbreak Straight	15/25 kV	DS225 CR4 CC3 T (see CR4 & CC3 Tables, page 15)	1
 CA650023EN	Deadbreak Junction	15/25 kV	DJ250-T2 (3-way, Type 2)	2, 3
 CA650024EN	Insulated Deadend Plug	15/25 kV	DPD250	2
 CA650024EN	Insulated Standoff Bushing	15/25 kV	DPS250	2
 CA650024EN	Grounded Standoff Bushing	15/25 kV	DPE250	2
 CA650024EN	Deadbreak Protective Cap	15/25 kV	DRC250	1
 CA650024EN	Coppertop Connectors for Deadbreak Elbows	15/25 kV	CC2C CC3 T (see CC3 Table, page 15)	
 CA650024EN	Crimp Connectors for Deadbreak Straight	15/25 kV	CC2C CC3 S (see CC3 Table, page 15)	
 CA650024EN	Probe and Probe Wrench for Deadbreak Elbow	15/25 kV	2638370C01EX (Probe) 2639205B01 (Probe Wrench)	
 CA650048EN	Bail Assembly for DE225	15/25 kV	2638409C06B	

**Use for
Base Number**

DE225
DS225

**TABLE CR4
Cable Diameter (Insulation) Range**

Cable Diameter Range		CABLE RANGE CODE
Inches	Millimeters	
0.531-0.685	13.5-17.4	BA
0.640-0.820	16.3-20.8	DA
0.770-0.950	19.6-24.1	FA
0.910-1.130	23.1-28.7	HA
1.100-1.320	27.9-33.5	JA

**Use for
Base Number**

DE225
DS225
CC2C

**TABLE CC3
Conductor Size and Type**

Concentric or Compressed		Compact or Solid		CONDUCTOR CODE
AWG	mm ²	AWG	mm ²	
No Connector				00
#6	16	#4	-	01
#4	-	#3	25	02
#3	25	#2	35	03
#2	35	#1	-	04
#1	-	1/0	50	05
1/0	50	2/0	70	06
2/0	70	3/0	-	07
3/0	-	4/0	95	08
4/0	95	250	120	09
250*	120	300	-	10

*Compressed stranding only.

200 A stacking dimensions

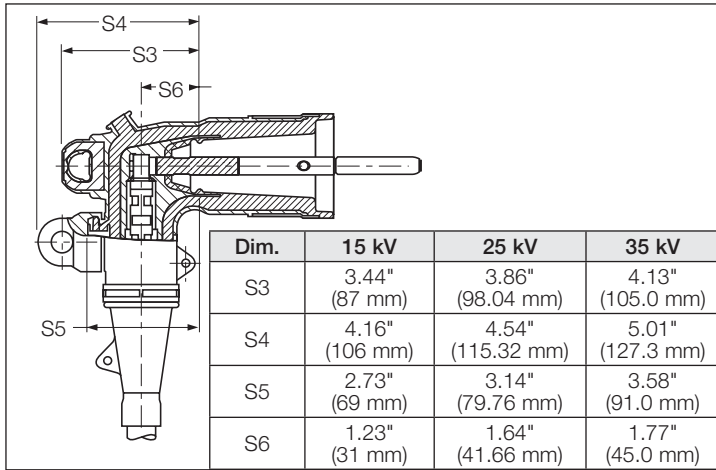

Elbow connector (25 kV POSI-BREAK shown)

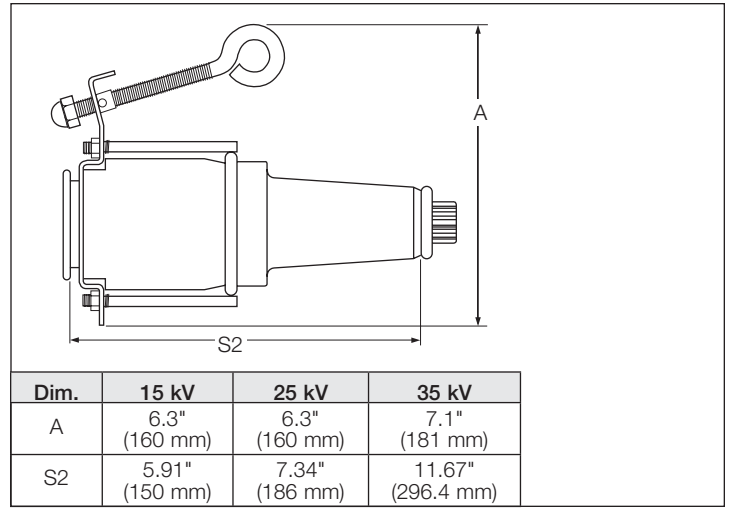

Insulated standoff bushing (25 kV shown)

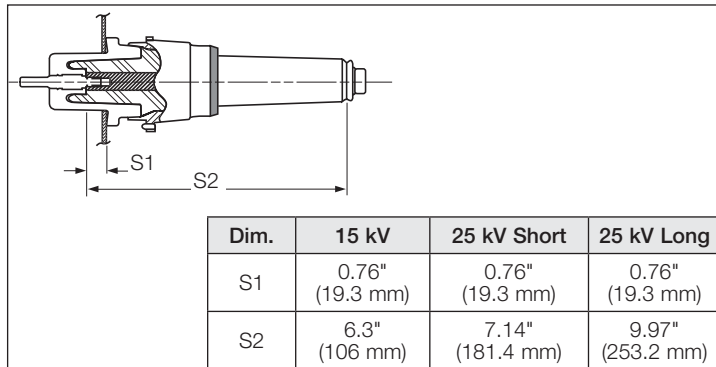

Vented bushing insert with latch ring indicator (25 kV shown)

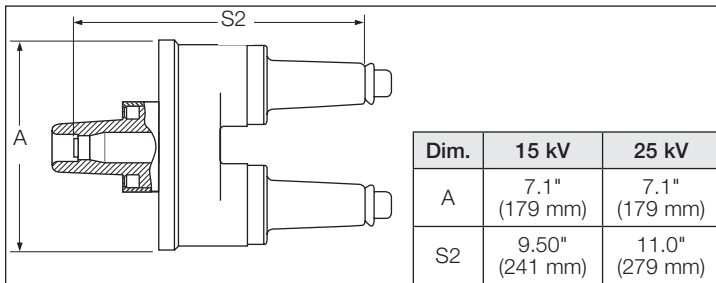
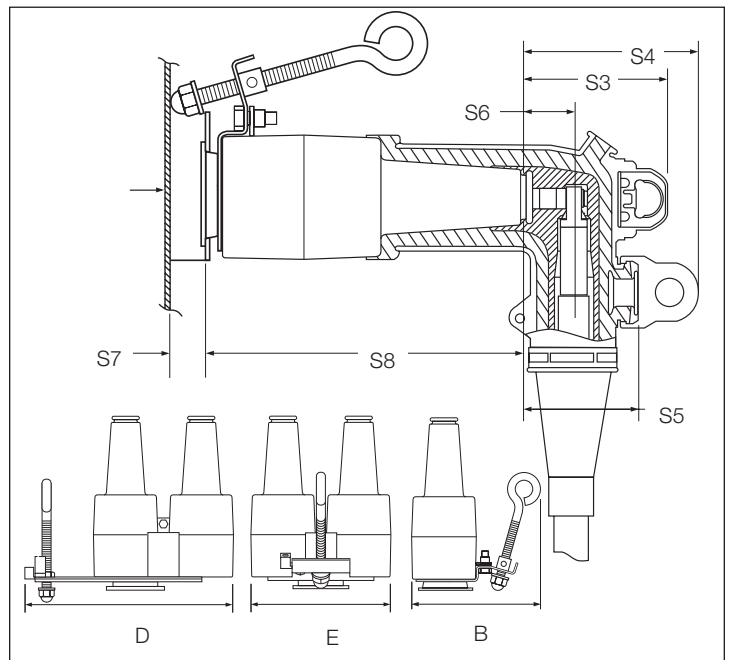

Rotatable feedthru insert (25 kV shown)

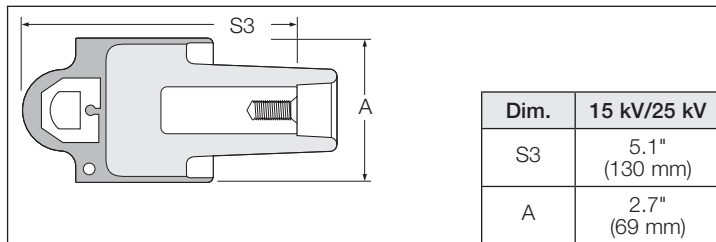

Insulated Bushing well plug

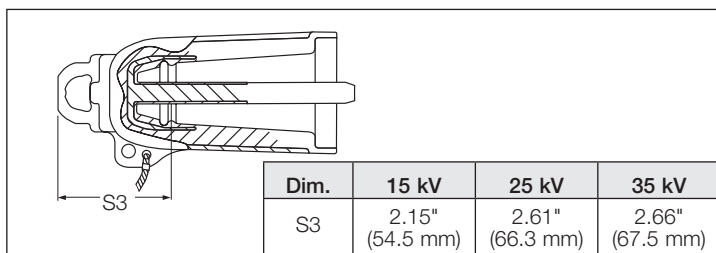

Loadbreak protective cap (25 kV POSI-BREAK shown)

Dim.	15 kV		25 kV		35 kV	
	Horizontal	Vertical	Horizontal	Vertical	Horizontal	Vertical
B	5.6" (142.2 mm)	-	5.6" (142.2 mm)	-	7.2" (182.9 mm)	-
D	-	8.9" (226 mm)	-	8.9" (226 mm)	-	11.6" (294 mm)
E	6.0" (153 mm)	-	6.7" (171 mm)	-	8.8" (224 mm)	-
S3	3.44" (87 mm)	3.44" (87 mm)	3.86" (98 mm)	3.86" (98 mm)	4.13" (105 mm)	4.13" (105 mm)
S4	4.16" (106 mm)	4.16" (106 mm)	4.54" (115 mm)	4.54" (115 mm)	5.01" (127.3 mm)	5.01" (127.3 mm)
S5	2.73" (69 mm)	2.73" (69 mm)	3.14" (80 mm)	3.14" (80 mm)	3.58" (91 mm)	3.58" (91 mm)
S6	1.23" (31 mm)	1.23" (31 mm)	1.64" (42 mm)	1.64" (42 mm)	1.77" (45 mm)	1.77" (45 mm)
S7	0.75" (19 mm)	0.75" (19 mm)	0.75" (19 mm)	0.75" (19 mm)	0.75" (19 mm)	0.75" (19 mm)
S8	7.07" (180 mm)	7.20" (183 mm)	8.63" (219 mm)	8.77" (223 mm)	11.8" (300 mm)	11.8" (300 mm)

Loadbreak portable feedthru (15 kV shown)

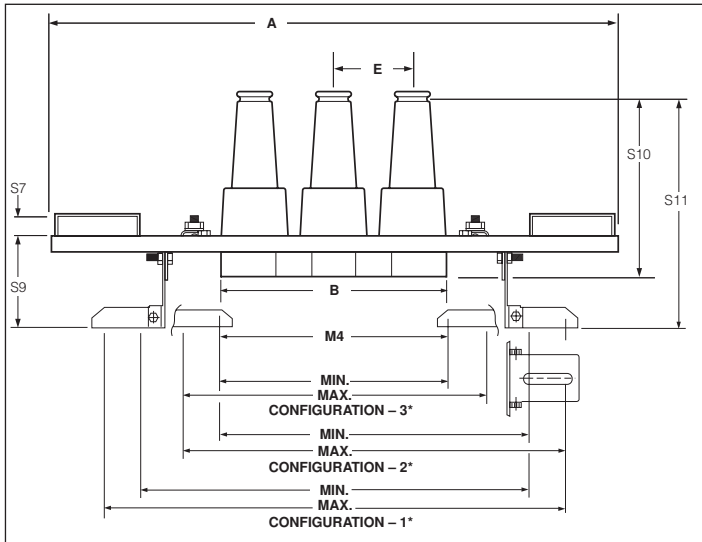

Dim.	15 kV	25 kV	35 kV
E	3.25" (83 mm)	4.0" (102 mm)	5.0" (127 mm)
S7	0.75" (19 mm)	0.75" (19 mm)	1.02" (26 mm)
S9	4.38" (111 mm)	4.38" (111 mm)	5.46" (139 mm)
S10	6.77" (172 mm)	8.34" (212 mm)	11.8" (299 mm)
S11	9.20" (234 mm)	10.77" (274 mm)	13.9" (163 mm)
M4	See Table 15 kV	See Table 25 kV	See Table 35 kV

TABLE 15 kV

Number of Interfaces	Physical Dimensions in./mm		M4 Mounting Dimensions in./mm					
			Configuration 1		Configuration 2		Configuration 3	
	A	B	Min.	Max.	Min.	Max.	Min.	Max.
2	12.5" (318 mm)	6.0" (152 mm)	10.8" (275 mm)	14.4" (366 mm)	7.2" (183 mm)	10.8" (275 mm)	3.6" (92 mm)	7.2" (183 mm)
3	19.6" (498 mm)	9.2" (230 mm)	14.7" (374 mm)	18.3" (465 mm)	11.1" (282 mm)	14.7" (374 mm)	7.4" (188 mm)	11.1" (282 mm)
4	22.9" (582 mm)	12.4" (315 mm)	17.9" (455 mm)	21.5" (547 mm)	14.3" (364 mm)	17.9" (455 mm)	10.7" (272 mm)	14.3" (364 mm)

Configuration 1. Both feet turned out.
 Configuration 2. One foot turned out, one in.
 Configuration 3. Both feet turned in.

TABLE 25 kV

Number of Interfaces	Physical Dimensions in./mm		M4 Mounting Dimensions in./mm					
			Configuration 1		Configuration 2		Configuration 3	
	A	B	Min.	Max.	Min.	Max.	Min.	Max.
2	14.2" (361 mm)	6.7" (170 mm)	11.9" (302 mm)	15.6" (396 mm)	8.0" (203 mm)	11.7" (297 mm)	4.2" (107 mm)	7.8" (198 mm)
3	23.0" (584 mm)	10.7" (272 mm)	16.8" (427 mm)	20.4" (518 mm)	12.9" (328 mm)	16.5" (419 mm)	9.0" (229 mm)	12.6" (320 mm)
4	27.0" (686 mm)	14.7" (373 mm)	20.8" (528 mm)	24.4" (620 mm)	16.9" (429 mm)	20.5" (521 mm)	13.0" (330 mm)	16.6" (422 mm)

Configuration 1. Both feet turned out.
 Configuration 2. One foot turned out, one in.
 Configuration 3. Both feet turned in.

TABLE 35 kV

Number of Interfaces	Mounting Dimensions in./mm			
	A	B	C	D
2	23.1" (587 mm)	8.8" (223 mm)	**	**
3	33.3" (846 mm)	13.8" (350 mm)	**	**
4	38.5" (978 mm)	18.8" (477 mm)	**	**

** Refer to Catalog Section CA650014EN for detailed drawing of 35 kV junction.

Loadbreak junctions (15 kV shown)

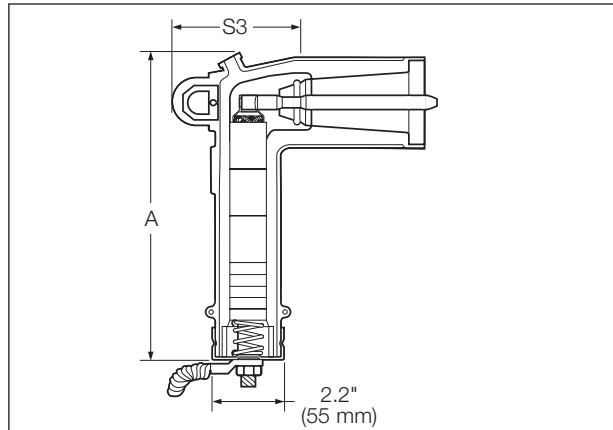

M.O.V.E. arrester

Dim.	Duty Cycle (kV)	15 kV/25 kV	35 kV
A	9-15	8.5" (216 mm)	-
	18-27	10.9" (276 mm)	13.3" (338 mm)
S3	9-27	4.2" (107 mm)	4.7" (120 mm)

M.O.V.E. Arrester

Dim.	Duty Cycle (kV)	15 kV/25 kV	35 kV
A	3-27	8.5" (216 mm)	13.3" (338 mm)
S3	3-27	4.2" (107 mm)	4.7" (120 mm)

Underground surge arresters

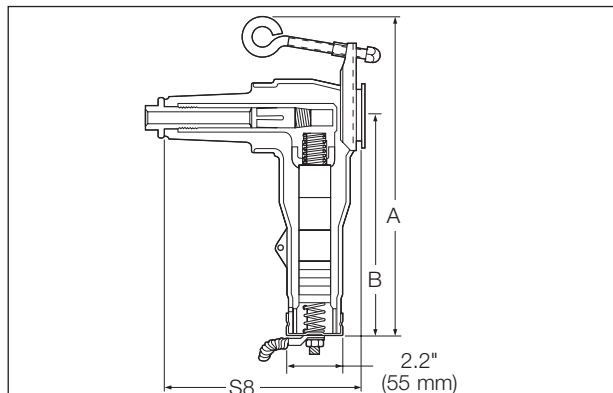

MOV parking stand arrester

Dim.	Duty Cycle (kV)	15 kV	25 kV
A	9-15	11.9" (302 mm)	11.9" (302 mm)
	18-21	14.5" (368 mm)	14.5" (368 mm)
B	9-15	8.0" (203 mm)	8.0" (203 mm)
	18-21	10.6" (269 mm)	10.6" (269 mm)
S8	9-21	7.4" (188 mm)	7.4" (188 mm)

MOV parking stand arrester

Dim.	Duty Cycle (kV)	15 kV	25 kV
A	3-21	11.9" (302 mm)	11.9" (302 mm)
B	3-21	8.0" (203 mm)	8.0" (203 mm)
S8	3-21	7.4" (188 mm)	7.4" (188 mm)

Parking stand arresters

Cleer loadbreak connector: 600 Amp loadbreak technology provides efficient, reliable visible break and visible ground



Cleer loadbreak connector system

Eaton's Cooper Power series Cleer™ loadbreak connector system is a 600 A loadbreak device rated for operation on 15 and 25 kV class systems. It is used to provide a visible break and visible ground on 600 A network and distribution systems without having to remove 600 A terminations and move heavy cable. The Cleer loadbreak connector system is fully shielded, submersible and meets the applicable requirements of IEEE Std 386™ standard - "Separable Insulated Connector Systems".

Many configurations are possible with this connector system. Under normal operating conditions, the current path is through one of the 600 A loadbreak/deadbreak 2-position junctions, through the 600 A loadbreak "C" (LCN) connector and through the second 600 A loadbreak/deadbreak junction.

When isolating underground cable, with the system energized or de-energized, with or without rated load current, with the use of a clampstick, the LCN connector can be removed.

A 600 A loadbreak protective cap (LPC6_ _) can then be installed on the two exposed loadbreak interfaces. All bushings of the connector system are then insulated and deadfront. If a 600 A termination with a 200 A reducing tap plug is used on the IEEE Std 386™ standard 600 A 15/25 kV deadbreak interfaces of the junction, a grounding elbow can be installed, providing a visible ground. It is then safe to perform work on the underground cable.

Once an underground circuit is sectionalized, for maximum safety, a visible break and visible ground must be achieved prior to performing any repair or maintenance. Distribution feeders can easily retrofit the Cleer loadbreak connector system into 600 A applications, allowing operators confidence when working on a piece of underground equipment or cable as they can clearly see the open circuit.

Cleer loadbreak connectors allow the operator to safely pull the loadbreak interface while the system is energized to sectionalize the system into smaller segments to prevent taking longer outages. The Cleer 600 A loadbreak connector makes this easy:

- The C-shaped connector breaks the circuit in two places for twice the contact separation.
- The new Cleer loadbreak connector incorporates field-proven POSI-BREAK technology which provides:
 - Increased strike distance, greatly reducing the possibility of partial vacuum flashovers
 - Added dielectric strength along the probes for superior switching performance and reliability
- The remainder of this simple system consists of:
 - Two Eaton's Cooper Power series 600 A loadbreak interfaces
 - Two IEEE Std 386™ standard 600 A deadbreak interfaces
- A yellow latch indicator is included to assure positive connection
- Fully submersible, and exceeds the applicable requirements of IEEE Std 386™ standard for use in above- and underground environments prone to flooding
- When using BT-TAP or T-OP II connectors a visible ground can be achieved by connecting a grounding elbow directly to a 200 A loadbreak reducing tap plug.

15 kV Class 600 A Cleer Loadbreak Connector System Ratings

600 A Loadbreak Interface	
Continuous Current	600 A rms
Loadbreak Switching	Ten make and break operations at 600 A at 14.4 kV Phase-Phase
	Three make and break operations at 900 A at 14.4 kV Phase-Phase
Fault Closure	16 kA rms symmetrical at 14.4 kV Phase-Phase after ten 600 A loadbreak switching operations for 0.17 seconds
	16 kA rms symmetrical at 14.4 kV Phase-Phase after three 900 A loadbreak switching operations for 0.17 seconds
4 Hour Overload Current	900 A rms
Short Time Current	16 kA rms symmetrical for 0.17 seconds (limited by fault closure rating)*
	10 kA rms symmetrical for 3.0 seconds
IEEE Std 386™ -2006 standard 600 A, 15/25 kV Deadbreak Interface	
Continuous Current	600 A rms
4 Hour Overload Current	900 A rms
Short Time Current	16 kA rms symmetrical for 0.17 seconds*
	10 kA rms symmetrical for 3.0 seconds

Current ratings and characteristics are in accordance with applicable IEEE Std 386™ -2006 standard requirements.

* 600 A loadbreak connectors are generally capable of short-time current ratings well in excess of those listed (25 kA to 40 kA ratings for 0.17s are typical). However, ratings are limited by the fault-closure rating. Contact your Eaton representative for maximum short-time current ratings if fault-closure operations are infeasible in your application.

25 kV Class 600 A Cleer Loadbreak Connector System Ratings

600 A Loadbreak Interface	
Continuous Current	600 A rms
Loadbreak Switching	Five make and break operations at 600 A at 26.3 kV Phase-Phase
	One make and break operation at 900 A at 26.3 kV Phase-Phase
Fault Closure	10 kA rms symmetrical at 26.3 kV Phase-Phase after five 600 A loadbreak switching operations for 0.17 seconds
	10 kA rms symmetrical at 26.3 kV Phase-Phase after one 900 A loadbreak switching operations for 0.17 seconds
4 Hour Overload Current	900 A rms
Short Time Current	10 kA rms symmetrical for 0.17 seconds (limited by fault closure rating)*
	10 kA rms symmetrical for 3.0 seconds
IEEE Std 386™ -2006 standard 600 A, 15/25 kV Deadbreak Interface	
Continuous Current	600 A rms
4 Hour Overload Current	900 A rms
Short Time Current	10 kA rms symmetrical for 0.17 seconds*
	10 kA rms symmetrical for 3.0 seconds

Current ratings and characteristics are in accordance with applicable IEEE Std 386™ -2006 standard requirements.

* 600 A loadbreak connectors are generally capable of short-time current ratings well in excess of those listed (25 kA to 40 kA ratings for 0.17s are typical). However, ratings are limited by the fault-closure rating. Contact your Eaton representative for maximum short-time current ratings if fault-closure operations are infeasible in your application.

28 kV Class 600 A Cleer Loadbreak Connector System Ratings

600 A Loadbreak Interface	
Continuous Current	600 A rms
Loadbreak Switching	Five make and break operations at 600 A at 28.0 kV Phase-Phase
	One make and break operation at 900 A at 28.0 kV Phase-Phase
Fault Closure	10 kA rms symmetrical at 28.0 kV Phase-Phase after five 600 A loadbreak switching operations for 0.17 seconds
	10 kA rms symmetrical at 28.0 kV Phase-Phase after one 900 A loadbreak switching operation for 0.17 seconds
4 Hour Overload Current	900 A rms
Short Time Current (See Important below)	25 kA rms symmetrical for 0.17 seconds (limited by fault closure rating)*
	10 kA rms symmetrical for 3.0 seconds
IEEE Std 386™ -2006 standard 600 A, 15/25 kV Deadbreak Interface	
Continuous Current	600 A rms
4 Hour Overload Current	900 A rms
Short Time Current (See Important below)	25 kA rms symmetrical for 0.17 seconds*
	10 kA rms symmetrical for 3.0 seconds

Current ratings and characteristics are in accordance with applicable IEEE Std 386™ -2006 standard requirements.

* 600 A loadbreak connectors are generally capable of short-time current ratings well in excess of those listed (25 kA to 40 kA ratings for 0.17s are typical). However, ratings are limited by the fault-closure rating. Contact your Eaton representative for maximum short-time current ratings if fault-closure operations are infeasible in your application.

600 A loadbreak connectors

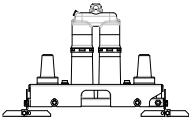
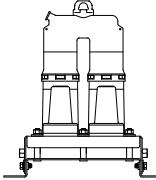
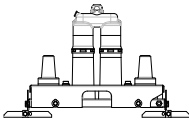
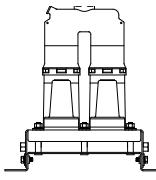
Catalog Section	Description	kV Class	Base Part Number	Notes
	Loadbreak Connector Assembly includes: two loadbreak/deadbreak junctions with loadbreak "C" connector assembled in an In-Line SS Bracket	15 kV	LCN2DLJ615A2ILB	
	Loadbreak Connector Assembly includes: two loadbreak/deadbreak junctions with loadbreak "C" connector assembled in a Square SS Bracket		LCN2DLJ615A2SQB	
	Loadbreak "C" Connector		LCN615	
CA650010EN	Loadbreak Protective Cap		LPC615	
	Loadbreak Connector Assembly includes: two loadbreak/deadbreak junctions with loadbreak "C" connector assembled in an In-Line SS Bracket	25 kV	LCN2DLJ625A2ILB	
	Loadbreak Connector Assembly includes: two loadbreak/deadbreak junctions with loadbreak "C" connector assembled in a Square SS Bracket	25 kV	LCN2DLJ625A2SQB	
	Loadbreak "C" Connector		LCN625	
CA650011EN	Loadbreak Protective Cap		LPC625	
	Loadbreak Connector Assembly includes: two loadbreak/deadbreak junctions with loadbreak "C" connector assembled In-Line SS Bracket	28 kV	LCN2DLJ628A2ILB	
	Loadbreak Connector Assembly includes: two loadbreak/deadbreak junctions with loadbreak "C" connector assembled in Square SS Bracket	28 kV	LCN2DLJ628A2SQB	
	Loadbreak "C" Connector		LCN628	
CA650012EN	Loadbreak Protective Cap		LPC628	
Accessories:				
	Loadbreak Standoff Bushing (Parking Stand Mount)	15/25 kV	PS625CLEER	
CA650010EN CA650011EN	Loadbreak Standoff Bushing (Direct Wall Mount)	15/25 kV	PS625CLEERDM	

Cleer SecTER sectionalizing cabinet information can be found on page 56

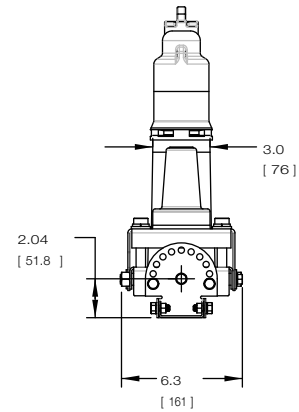
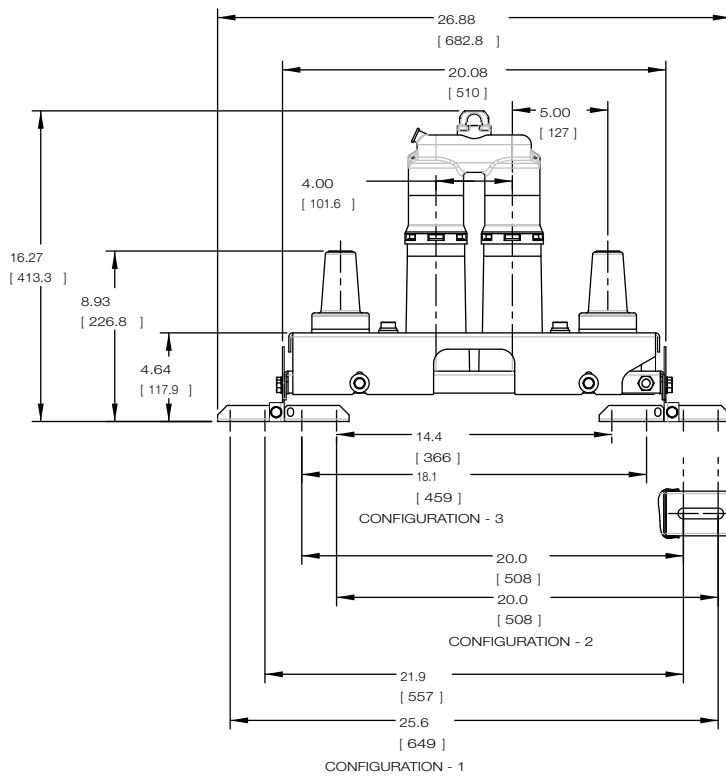

Clear Loadbreak Connector Assembly
(In-Line SS Bracket).

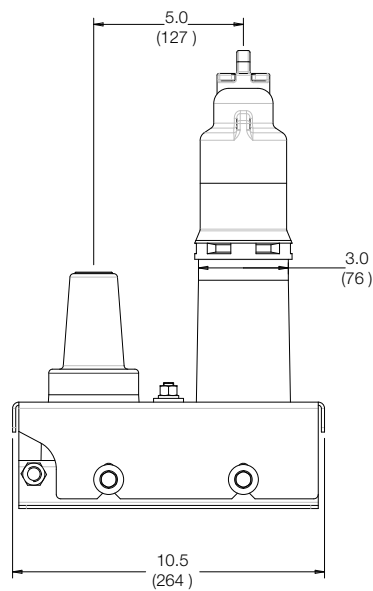
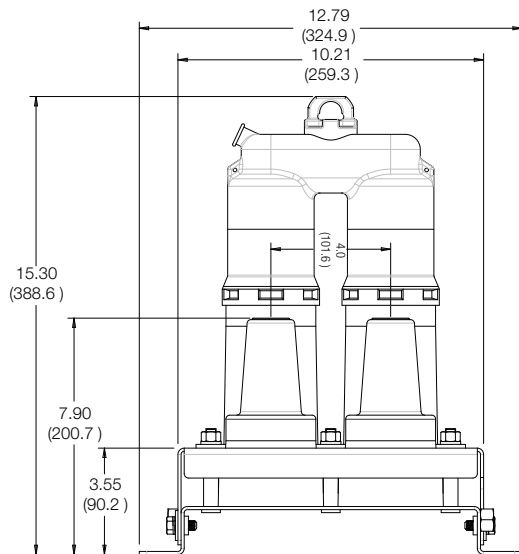

Clear Loadbreak Connector Assembly
(Square SS Bracket).

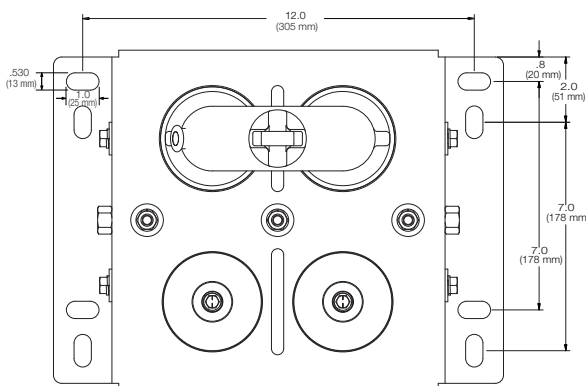

600/900 A deadbreak connectors

Eaton designs its Cooper Power series 600/900 A deadbreak connector systems to fill the demand for a deadfront underground installation in 600/900 A main and lateral feeders. They provide a completely shielded, deadfront, fully submersible cable connection for high-voltage apparatus – such as transformers, switchgear, large motors, etc., and can also be used to make splices, junctions, taps and deadends for main underground, distribution feeders. They provide the same high degree of operating flexibility and reliability as our 200 A products. All components fit together easily and assembly variations are available.

These connector systems are designed for installation on various types of cables. The entire system can be applied to concentric neutral cable, and with our CS & SA Series Shield Adapter Kits to almost any other type of cable.

All of our deadbreak connectors meet the electrical, mechanical and dimensional requirements of IEEE Std 386™ standard and are designed to be fully interchangeable with those currently available from other major manufacturers.

900 A rating

Eaton achieves a 900 A continuous rating with its Cooper Power series BOL-T™, BT-TAP™ and T-OP™ II systems when used with a coppertop compression connector and all copper mating components including apparatus bushing or junction. (See note 1 on page 23 for details when selecting a system.)

BOL-T connector system

Eaton designs its Cooper Power series BOL-T Deadbreak Connector System for use on applications where the terminations would not be operated after installation, would not need a 200 A interface for grounding or arrester provisions, and would not require direct conductor testing or the use of a hotstick. It is a bolted design that is interchangeable with other manufacturers' bolted 600/900 A systems and requires no special tools for installation.

BT-TAP connector system

Eaton's Cooper Power series BT-TAP deadbreak connector system includes a 200 A loadbreak tap instead of the standard insulated plug. The other components of BT-TAP are the same as BOL-T, making it an ideal option to retrofit existing BOL-T (or other bolted systems that use unthreaded compression connectors) systems with a 200 A loadbreak tap for testing, grounding, or overvoltage protection.

T-OP II connector system

Eaton's Cooper Power series T-OP II deadbreak connector system also has a 200 A loadbreak tap and has all the advantages of the BT-TAP system. In addition, the T-OP II connector is single-person hotstick operable, making it ideal for terminations that may require moving or sectionalizing to achieve a visible open or visible ground. The T-OP II connector design offers added reliability (900 A rated all copper alloy current path and copper top connector) and has several assembly/operating advantages.







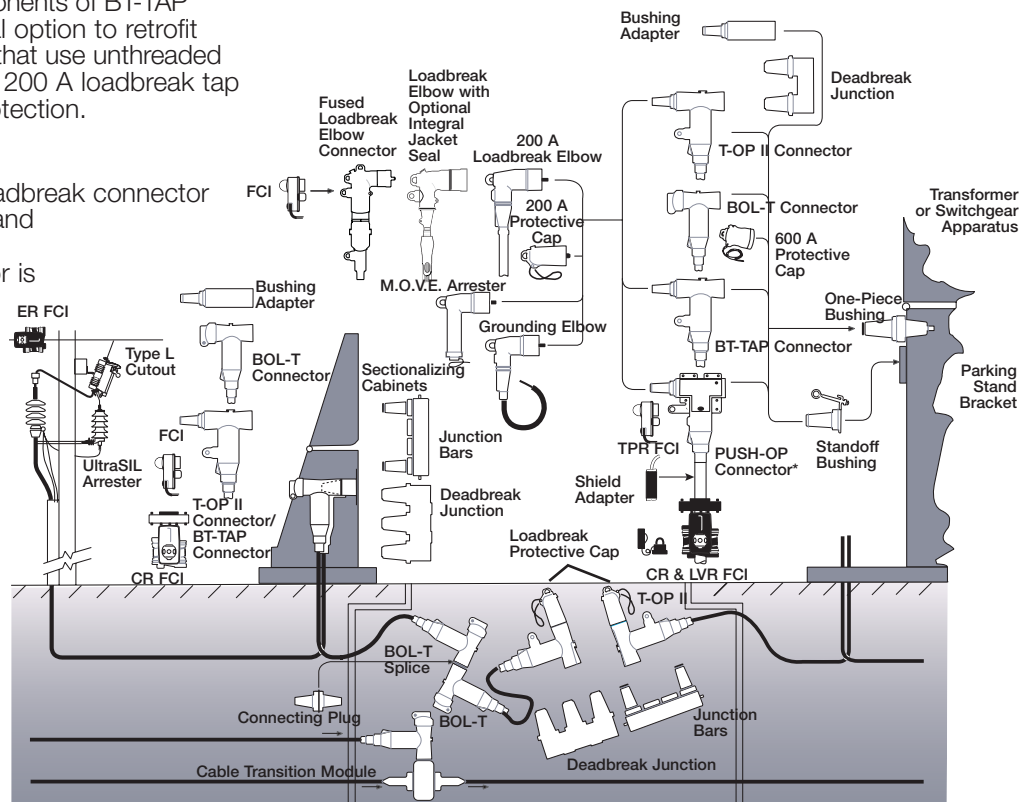

PUSH-OP connector system

Eaton's Cooper Power series PUSH-OP™ deadbreak connector system is essentially a T-OP II termination with a non-bolted design for use on any deadfront apparatus where the terminations may be operated frequently. The PUSH-OP connector's 600 A deadbreak probe and finger contact design eliminates cross-threading and normal thread wear during repeated sectionalizing operations. It is the only available system that allows operators to move the terminator while it is fully grounded. The PUSH-OP system provides stainless steel bracketry and a mechanical lever for the fastest and easiest one-person hotstick operation possible. The PUSH-OP system requires special apparatus bushings, which makes it suitable for new installations only.

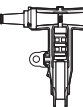
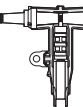
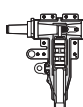
Note: 600 A Separable Splice kits can be found in the splice section starting on page 36.

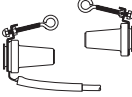
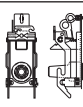

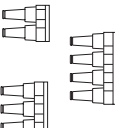
PUSH-OP requires modified bushing and tank hardware.

Catalog Section	Description	kV Class	Base Part Number	Notes
 CA650003EN CA650008EN	BOL-T Connector Kit	15/25 kV	BT625 CR5 CC4 (see CR5 & CC4 Tables pg. 24)	1, 2, 3, 4, 13, 14
		35 kV	BT635 CR6 CC4 (see CR6 & CC4 Tables pg. 24)	1, 2, 3, 4, 13, 14
 CA650002EN CA650001EN CA650009EN	BT-TAP Connector Kit	15 kV	BTP615 CR5 CC4 (see CR5 & CC4 Tables pg. 24)	1, 2, 3, 4, 6, 13, 14
		25 kV	BTP625 CR5 CC4 (see CR5 & CC4 Tables pg. 24)	1, 2, 3, 4, 6, 13, 14
		35 kV	BTP635 CR6 CC4 (see CR6 & CC4 Tables pg. 24)	1, 2, 4, 6, 13, 14
 CA650017EN CA650059EN CA650055EN	T-OP II Connector Kit	15 kV	TP615 CR5 CC4 (see CR5 & CC4 Tables pg. 24)	2, 5, 6, 13, 14
		25 kV	TP625 CR5 CC4 (see CR5 & CC4 Tables pg. 24)	2, 5, 6, 13, 14
		35 kV	TP635 CR6 CC4 (see CR6 & CC4 Tables pg. 24)	2, 5, 6, 13, 14
 CA650019EN CA650018EN CA650052EN	PUSH-OP Connector Kit	15 kV	POP615 CR5 CC4 (see CR5 & CC4 Tables pg. 24)	2, 5, 6, 13, 14
		25 kV	POP625 CR5 CC4 (see CR5 & CC4 Tables pg. 24)	2, 5, 6, 13, 14
		35 kV	POP635 CR6 CC4 (see CR6 & CC4 Tables pg. 24)	2, 5, 6, 13, 14
 CA650041EN CA650042EN CA650054EN	Bushing Adapter with LRTP (STUD-T Included)	15 kV	DBA615	6
		25 kV	DBA625	6
		35 kV	DBA635	6
 CA650019EN CA650103EN CA650056EN	PUSH-OP Bushing Adapter	15 kV	PDBA615	6
		25 kV	PDBA625	6
		35 kV	PDBA635	6
 CA650066EN CA650057EN	Standoff Bushings	15/25 kV	ISB625A (Aluminum) ISB625C (Copper)	7, 8
		35 kV	ISB635A (Aluminum) ISB635C (Copper)	7, 8 7
 CA650043EN CA650064EN CA650049EN	PUSH-OP Standoff Bushings	15/25 kV	PISB625 PISB625HP (with hitch pin)	
		35 kV	PISB635 PISB635HP (with hitch pin)	
 CA650060EN CA650058EN	Standard Protective Cap (with Permanent Stud)	15/25 kV	DPC625	9
		35 kV	DPC635	9
 CA650060EN CA650058EN	Protective Cap for T-OP II and	15/25 kV	DPC625UT	9
		35 kV	DPC635UT	9
 CA650096EN CA650053EN	Deadbreak Junctions	15/25 kV	DJ625A (Aluminum) DJ625C (Copper)	10, 11 10, 11
		35 kV	DJ635A (Aluminum) DJ635C (Copper)	10, 11 10, 11
	SA Series Cold Shrinkable Metallic Shield Adapter Kit	15/25/35 kV	SA CJ3 (see CJ3 Table pg. 24)	12, 13, 14
	CS Series Cold Shrinkable Metallic Cable Seal Kit	15/25/35 kV	CS CJ4 (see CJ4 Table pg. 24)	13, 14

- Determine whether all aluminum components or all copper components are required:
BOL-T Kit with 600 A Rating - Insert "A" in digit 10 (digit 9 for 35 kV) for Aluminum.
BT-TAP Kit with 600 A Rating - Insert "A" in digit 11 (digit 10 for 35 kV) for Aluminum.
BOL-T Kit with 900 A Rating - Insert "C" in digit 10 (digit 9 for 35 kV) for Copper (includes coppertop compression connector).
BT-TAP Kit with 900 A Rating - Insert "C" in digit 11 (digit 10 for 35 kV) for Copper (includes coppertop compression connector).
- To specify an **ALL copper connector**, add 50 to the conductor code from Table CC4 (page 24). **Example:** CC6C11T becomes CC6C61T.
- To specify a **stud**:
BOL-T Kit - insert a "1" in digit 11 to include stud, or a "2" in digit 11 for kit without stud.
BT-TAP Kit - insert "S" in digit 12 to include standard length stud or "L" in digit 12 to include extended length stud.
- To specify T-Body with test point (optional):
BOL-T Kit - insert a "T" in digit 12.
BT-TAP Kit (15 & 25 kV) - insert a "T" in digit 13.
BT-TAP Kit (35 kV) - insert a "T" in digit 11.
- For T-OP II and PUSH-OP kits only, to specify a T-Body with test point, add "T" after the conductor code.
- To specify a **BOL-T, BT-TAP or T-OP II** kit with a **loadbreak protective cap**, insert a "C" after the test point/non-test point option. **Bushing Adapters** - insert a "C" as the last character of the part number. **Note:** 25 kV kits include a **POSI-BREAK protective Cap**.
- To specify stud in kit, add "SA" for aluminum stud (only available with aluminum interface); add "SC" for copper stud; add "ST" for T-OP II stud; or add "SU" for U-OP stud as the last characters in the part number.
- To specify a **grounded standoff bushing**, replace the "I" with a "G" as the first character in the part number.
- For **individually packaged** product in a corrugated cardboard box, insert an "X" as the last character in the part number.
- It is required to specify the number of interfaces by inserting a "2", "3", or "4" directly after the base part number.
- To add a **stainless steel bracket**, insert a "B"; or to add **U-straps**, insert a "U" as the last character in the part number.
- For use with tape shield, drain wire, linear corrugated, and Unishield® cable.
- To add a **CS Series Sealing kit** or a **SA Series Adapter kit** to the 600 A connector kit, add a "SA_" or "CS_" at end of catalog number. Refer to Table CJ3 or CJ4 on page 24.
- Each **SA Series Kit** includes:
(1) Cold Shrinkable Sleeve (1) Tinned Copper Ground Strap with attached elbow drain wire (1) Constant Force Spring (1) Semi-Conductive Tape (3) Mastic Sealing Strips (1) Installation Instructions.
Each CS Series Sealing Kit includes:
(1) Cold shrinkable sleeve, (3) Mastic sealing strips, and (1) Installation Instructions.

600/900 A components & replacement parts

Use for Base Number

BT625
BTP615
BTP625
TP615
TP625
POP615
POP625
CA625

TABLE CR5
Cable Diameter (Insulation) Range

Cable Diameter Range		
Inches	mm	CABLE RANGE CODE
0.610-0.970	15.5-24.6	AB
0.750-1.080	19.1-27.4	CC
0.970-1.310	24.6-33.3	DD
1.090-1.470	27.7-37.3	EE
1.260-1.640	32.0-41.7	FF
1.360-1.710	34.5-43.4	GG
1.500-1.850	38.1-47.0	HH
1.700-1.970	43.2-50.0	JJ

Use for Base Number

BT625
BT635
BTP615
BTP625
BTP635
TP615
TP625
TP635
POP615
POP625
POP635
CC6A _ U
CC6C _ T
CC6C _ U
CDT _____

TABLE CC4
Conductor Size and Type

Concentric or Compressed		Compact or Solid		CONDUCTOR CODE
AWG or kcmil	mm ²	AWG or kcmil	mm ²	
No Connector				00
#2	35	1	-	11
#1	-	1/0	50	12
1/0	50	2/0	70	13
2/0	70	3/0	-	14
3/0	-	4/0	95	15
4/0	95	250	120	16
250	120	300	-	17
300	-	350	-	18
350	-	400	185	19
400	185	450	-	20
450	-	500 ^a	240	21
500	240	600	300	22
600	300	700	-	23
650 ^b	-	750 ^c	-	24
750 ^d	-	900	-	25
900	-	1000	500	26
1000	500	-	-	27
1250	630	-	-	28

- a. Also accepts 550 kcmil compact conductor.
b. Also accepts 700 kcmil compressed conductor.
c. Also accepts 800 kcmil compact conductor.
d. Also accepts 700 kcmil concentric conductor.

Use for Base Number

SA

TABLE CJ3
Cable Jacket (Outside Diameter) Range

Cable Jacket OD (Inches)	JACKET CODE
0.590-1.050	1
0.830-1.640	2
1.270-2.170	3
1.600-2.600	4

Use for Base Number

CS

TABLE CJ4
Jacketed Concentric Neutral Cable

Minimum Seal Diameter (Inches)	Maximum Installed Diameter(Inches)	CODE
.950	1.94	1
1.28	2.67	2
1.60	3.50	3

Use for Base Number

BT635
BTP635
TP635
POP635
CA635

















TABLE CR6
Cable Diameter (Insulation) Range

Cable Diameter Range		
Inches	mm	CABLE RANGE CODE
0.875-0.985	22.2-25.0	D
0.930-1.040	23.6-26.4	E
0.980-1.115	24.9-28.3	F
1.040-1.175	26.4-29.8	G
1.095-1.240	27.8-31.5	H
1.160-1.305	29.5-33.1	J
1.220-1.375	31.0-34.9	K
1.285-1.395	32.5-35.4	L
1.355-1.520	34.4-38.6	M
1.485-1.595	37.7-40.5	N
1.530-1.640	38.9-41.7	P
1.575-1.685	40.0-42.8	Q
1.665-1.785	42.3-45.3	R
1.755-1.875	44.6-47.9	S
1.845-1.965	46.9-50.0	T
1.960-2.210	49.8-56.1	U

Shear Bolt Connector

Cable Conductor Size				Shear Bolt Connector	
AWG or kcmil			mm2 Standard Sized	Conductor Code	Catalog Number
Compact	Compressed	Concentric			
1/0	1/0	1/0	50	S1	CDT630SB150
2/0	2/0	2/0	70		
3/0	3/0	3/0	-		
4/0	4/0	4/0	95		
250	250	250	120		
350	-	-	150	S3	CDT630SB300
-	350	350	185		
500	500	500	240		
600	600	600	300		
700	-	-	-		
-	700	700	-	S4	CDT630SB400
750	750	750	-		
800	800	-	400		
900	-	-	-		
-	-	800	-		
-	900	900	-	S6	CDT1250SB630
1000	1000	1000	500		
-	1100	1100	-		
-	1200	1200	-		
-	1250	1250	630		
-	1300	1300	-	S8	CDT1250SB800
-	1400	1400	-		
-	1500	1500	800		

Not available with T-OP II or PUSH OP.

Catalog Section	Description	kV Class	Base Part Number	Notes
 CA650007EN CA650006EN	T-Body	15/25 kV	DT625	1, 2
		35 kV	DT635	1, 2
 CA650007EN CA650006EN	Cap for Insulating Plug	15/25/35 kV	DIPCAP	
		 CA650007EN CA650006EN	15/25 kV	DIP625A (Aluminum) DIP625C (Copper)
 CA650007EN CA650006EN	Connecting Plug w/o Stud		35 kV	DIP635A (Aluminum) DIP635C (Copper)
		15/25 kV	DCP625A (Aluminum) DCP625C (Copper)	3, 7
 CA650007EN CA650006EN	BOL-T Stud	15/25 kV	STUD-A (Aluminum) STUD-C (Copper)	
		35 kV	STUD635-A (Aluminum) STUD635-C (Copper)	3, 7
 CA650007EN CA650006EN	T-OP II Stud	15/25/35 kV	STUD-T	4
 CA650007EN CA650006EN	11/16 in. Unthreaded Aluminum Compression Connector	15/25/35 kV	CC6A CC4 U (see CC4 Table pg. 24)	
 CA650007EN CA650006EN	15/16 in. Threaded Coppertop Compression Connector	15/25/35 kV	CC6C CC4 T (see CC4 Table pg. 24)	6
 CA650007EN CA650006EN	11/16 in. Unthreaded Coppertop Compression Connector	15/25/35 kV	CC6C CC4 U (see CC4 Table pg. 24)	6
 CA650007EN CA650006EN	Cable Adapter	15/25 kV 35 kV	CA625 CR5 (see CR5 Table pg. 24) CA635 CR6 (see CR6 Table pg. 24)	
 CA650007EN CA650006EN	T-OP II Installation and Torque Tool	15/25 kV 35 kV	TQHD625 (15/25 kV-T-OP II Only) TQHD635 (35 kV T-OP II Only)	8
 CA650007EN CA650006EN	T-OP II Combination Operating, Test, and Torque Tool (For single person hotstick operation)	15 kV	OTTQ615	9
		25 kV	OTTQ625	9
		35 kV	OTTQ635	9
 CA650007EN CA650006EN	T-WRENCH for BT-TAP/T-OP II	15/25/35 kV	TWRENCH	10
	5/16" Hex Shaft with 3/8" Socket Drive Tool	15/25 kV	HD625	11
		35 kV	HD635	11
	Bushing Extender	15/25 kV	DBE625	2
		35 kV	DBE635	2
 CA650041EN CA650042EN CA650054EN	Loadbreak Reducing Tap Plug for T-OP II (Stud-T included)	15 kV	LRTP615	
		25 kV	LRTP625	
		35 kV	LRTP635	
 CA650041EN CA650042EN CA650054EN	BOL-T Loadbreak Reducing Tap Plug for BT-TAP	15 kV	BLRTP615	12, 13
		25 kV	BLRTP625	12, 13
		35 kV	BLRTP635	

- To specify a **test point** insert a "T" in the sixth digit.
- To add stud to kit, add a "SA" for an **aluminum stud**, or a "SC" for a **copper stud** as the last characters in the part number.
- To add **STUD** to kit, add a "S" after the base part number. Material of stud supplied will match with material of the plug conductor ordered.
- Copper alloy stud for use with T-OP II connectors only.
- To specify an **all copper connector**, add **50** to the conductor code from Table CC4 (page 24). Example: CC6C11T becomes CC6C61T.
- Stud comes loose in kit, add a "P" as the last character for permanent **factory installation**.
- TQHD6_ allows for installation of T-OP II connector to 600 A bushing.
- OTTQ6_ allows for installation and single hotstick operation of T-OP II connector.
- TWRENCH allows for installation of loadbreak reducing tap plug for BT-TAP or T-OP II connector.
- HD6_ allows for installation of BLRTP6_ reducing tap plug and connecting plug in 600 A separable splices.
- Specify "A" for 600 A rating or "C" for 900 A rating in digit 9.
- To add standard length stud to kit, add "S" to end of part number. To add an extended length stud to kit add "L" to end of part number.

BOL-T connector system

Eaton designs its Cooper Power series BOL-T deadbreak connector system for use on applications that will not be operated, do not need grounding or arrester provisions, and do not require direct conductor testing or the use of a hotstick. It is a bolted design that is interchangeable with other manufacturers' bolted 600 A systems that require no special tools for installation.

The capacitive test point on the insulating plug provides a means of confirming an energized circuit without disturbing the bolted connection. In addition to the capacitive test point feature on the insulating plug, we offer a capacitive test point on the T-Body. This allows the use of our "TPR" faulted circuit indicators, and provides a means of confirming that a circuit is energized when used with high impedance voltage sensing devices designed for test points.

Refer to Figure 1 for BOL-T connector kit components.

Installation of BOL-T on a 600/900 A bushing

The BOL-T connector is installed on any 600/900 A bushing using a standard 1-inch socket. No special tools are required.

BOL-T specification information

To specify the BOL-T connector system, include in your specification:

- The system must fully comply with IEEE Std 386™ standard.
- All cable adapters, insulating plugs, compression connectors and other component parts must be interchangeable with other manufacturers.
- For 900 A rating, full copper current carrying path with coppertop compression connector, copper stud and insulating plug with copper insert.
- BOL-T connector system base part number BT625 for 15 kV and 25 kV systems and BT635 for 35 kV systems.

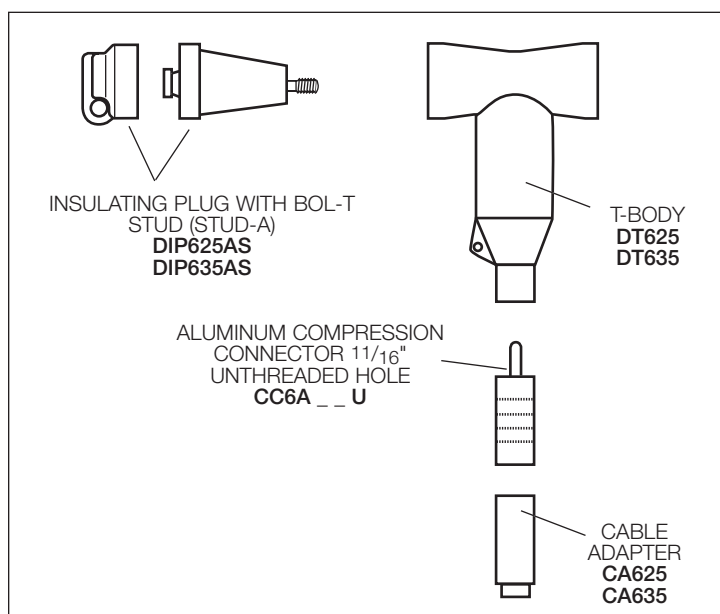

Figure 1. BOL-T connector kit (BT6.5) components. For more details, see catalog sections CA650003EN and CA650008EN.

BT-TAP connector system

The BT-TAP deadbreak connector system is designed for use on applications where a 200 A interface is required for testing, grounding, or overvoltage protection. It is primarily used in retrofit applications of existing 600 A or 900 A BOL-T installations (or other bolted systems that use unthreaded compression connectors).

The BT-TAP connector system uses the standard unthreaded compression connector, which makes it ideal for retrofitting existing BOL-T connector installations into a system with a 200 A tap.

The BT-TAP connector provides the following features:

- Visible ground and visible break
- 200 A Interface for:
 - addition of our M.O.V.E. arresters for overvoltage protection
 - addition of our grounding elbows
 - access for direct conductor phasing and testing
 - hipot testing of switch or cables

Refer to Figure 2 for BT-TAP connector kit components.

Installation of BT-TAP on a 600 A bushing

The BT-TAP connector is installed on an apparatus bushing using a 600 A torque tool.

BT-TAP specification information

To specify a BT-TAP connector system, include in your specification:

- The system must fully comply with IEEE Std 386™ standard.
- The connector system must provide operation with hot line tools, direct conductor phasing and testing.
- It must provide a location to add overvoltage arresters and access for direct conductor phasing or hipot testing of switch or cables.
- Must be easy to install with proper torque such that concern for cross threading is eliminated.
- Loadbreak reducing tap plug must include latch indicator ring.
- BT-TAP Connector System base part number BTP615 (A) (C) for 15 kV, BTP625 (A) (C) for 25 kV and BTP635 for 35 kV.

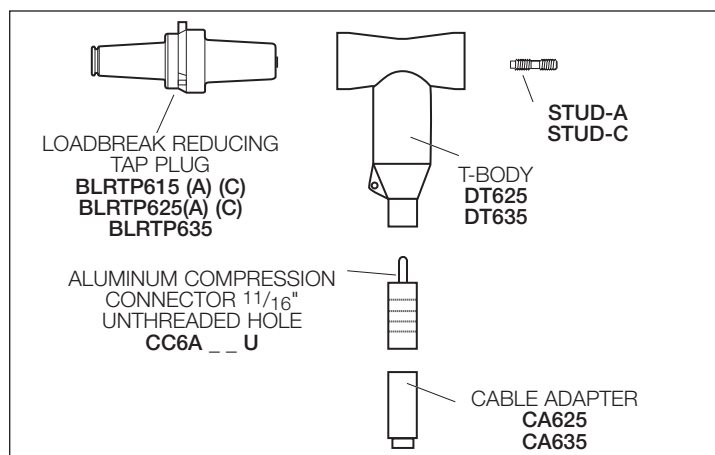

Figure 2. BT-TAP connector kit (BTP6.5) components. For more details, see catalog sections CA650002EN, CA650001EN and CA650009EN.

T-OP II connector system

Eaton designs its Cooper Power series T-OP II deadbreak connector system for use on applications where a 200 A interface is required for testing, grounding, or overvoltage protection. It is single person hotstick operable and is ideal for terminations that may require moving to achieve a visible open or visible ground. One person can move the T-OP II deadbreak terminator from the apparatus bushing to a standoff bushing using a hotstick and operating test and torque tool (OTTQ6_5). The T-OP II connector system uses a threaded coppertop (bi-metal) compression connector for a threaded connection. It also has an alignment segment and internal rotating nut feature in the loadbreak reducing tap plug which, along with the extended length stud, eliminates cross threading and ensures proper torque.

The T-OP II system provides the following features:

- Single person hotstick operable
- Mechanical assist
- Copper alloy current path and copper-top connector
- 900 A continuous current rating
- Visible ground and visible break
- 200 A Interface for:
 - addition of our M.O.V.E arresters for overvoltage protection
 - addition of our grounding elbows
 - access for direct conductor phasing and testing
 - hipot testing of switch or cables

Refer to Figure 3 for T-OP II connector kit components.

Installation of T-OP II on a 600/900 A bushing

The T-OP II connector is installed on an apparatus bushing using a T-Wrench and a 600 A torque tool.

T-OP II specification information

To specify a 900 A T-OP II system, include in your specification:

- The system must fully comply with IEEE Std 386™ standard.
- Must include an all copper alloy current path and copper-top connector.
- System must include disconnecting back-off feature.
- The connector system must provide operation with live line tools, direct conductor phasing and testing, visible ground and visible break.
- It must provide a location to add overvoltage arresters and access for direct conductor phasing or hipot testing of switch or cables.
- Must be one-person hotstick operable and easy to install with proper torque such that concern for cross threading is eliminated.
- Loadbreak reducing tap plug must include extended length stud, internal rotating nut and an alignment segment feature to eliminate cross threading of this compression connector and ensure proper torque.
- Loadbreak reducing tap plug must include latch indicator ring.
- T-OP II connector system base part number TP615 for 15 kV, TP625 for 25 kV and TP635 for 35 kV.

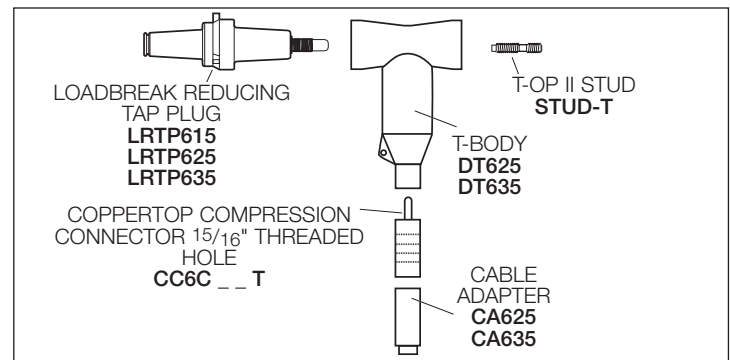
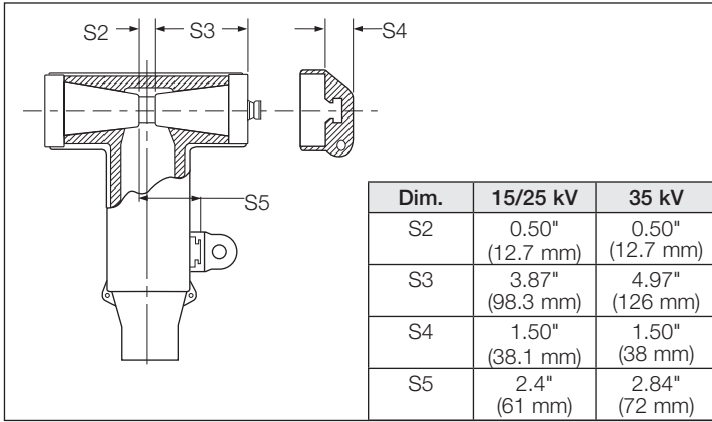
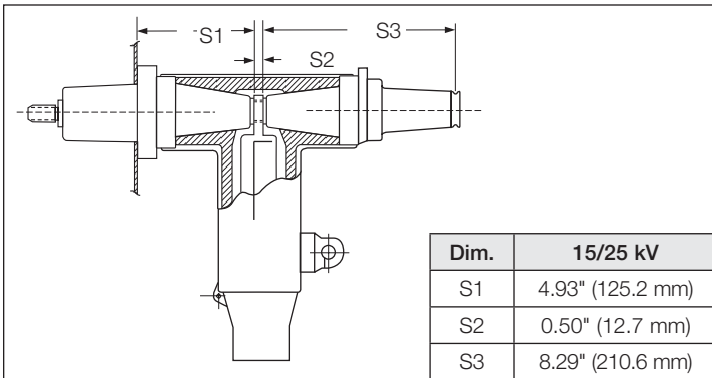

Figure 3. T-OP II connector kit (TP6_5_) components. For more details, see catalog sections CA650017EN, CA650059EN, CA650055EN.

600 A stacking dimensions



BOL-T deadbreak connector



BT-TAP and T-OP II deadbreak connector 15 kV and 25 kV

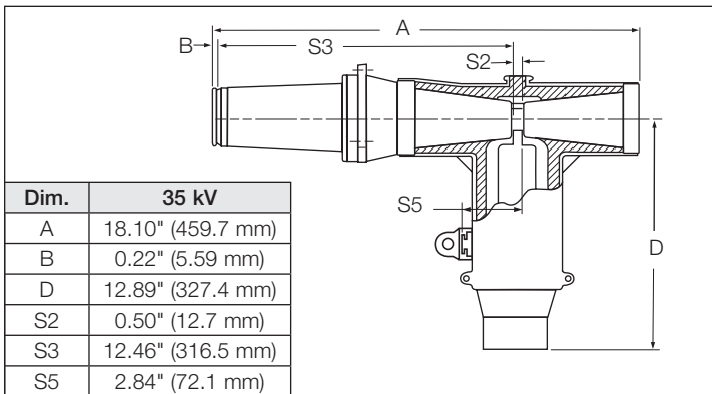

BT-TAP and T-OP II deadbreak connector 35 kV

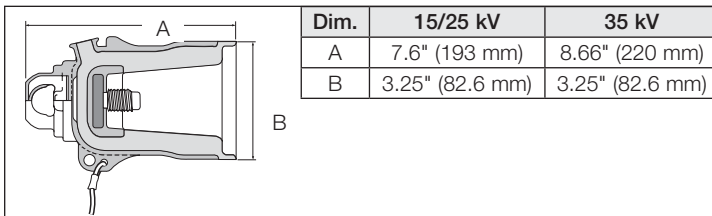

Standard protective cap

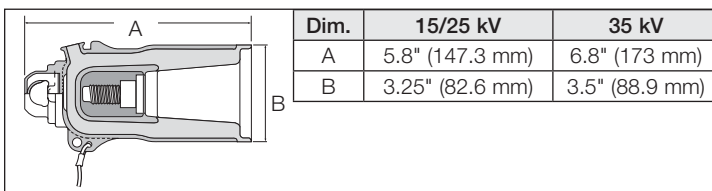

Protective cap for T-OP II and U-OP (15/25 kV shown)

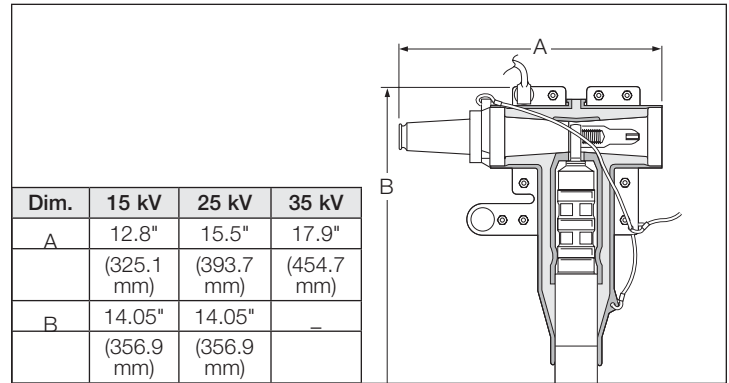

PUSH-OP deadbreak connector (15 kV shown)

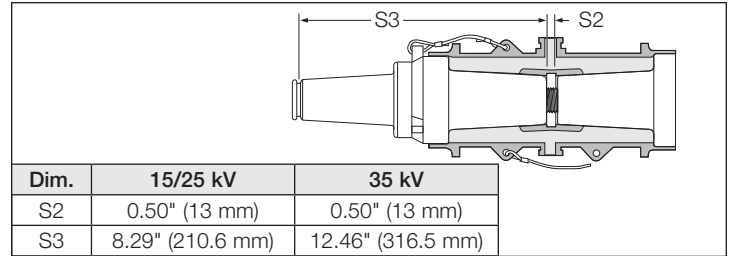

Bushing adapter with LRTP (15 kV shown)

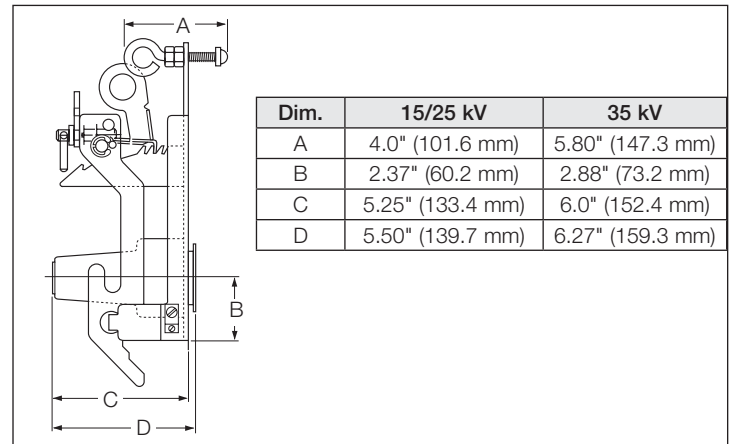

PUSH-OP standoff bushing (15/25 kV shown)

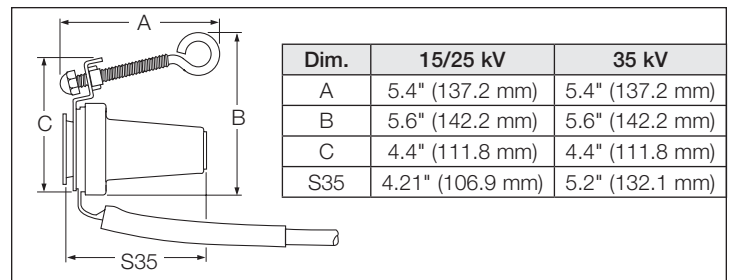

Standoff bushing

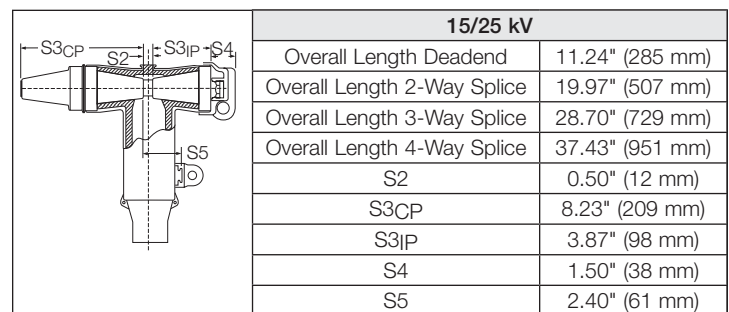

Separable splice

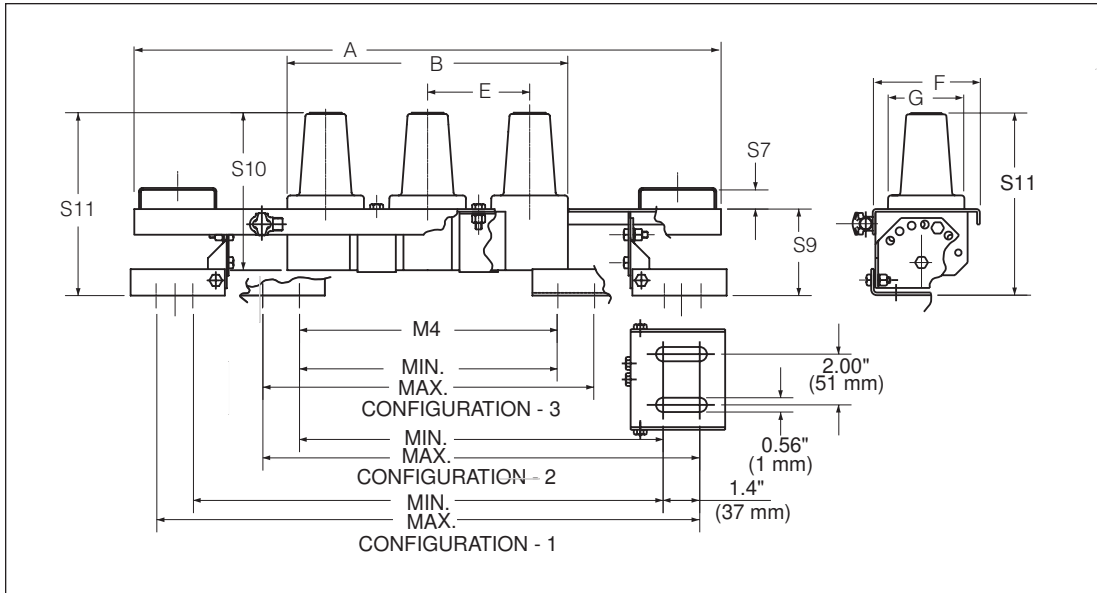

Deadbreak junction (15/25 kV shown)

TABLE 15/25 kV

Number of Interfaces	Physical Dimensions in./(mm)		M4 Mounting Dimensions in./(mm)					
			Configuration 1		Configuration 2		Configuration 3	
			Min.	Max.	Min.	Max.	Min.	Max.
2	19.0" (483 mm)	7.0" (178 mm)	14.1" (358 mm)	16.9" (429 mm)	9.7" (248 mm)	12.5" (318 mm)	5.6" (142 mm)	8.4" (213 mm)
3	23.0" (584 mm)	11.0" (279 mm)	18.6" (472 mm)	21.4" (544 mm)	14.2" (361 mm)	17.0" (432 mm)	10.1" (257 mm)	12.9" (328 mm)
4	27.1" (686 mm)	15.0" (381 mm)	24.1" (612 mm)	26.9" (686 mm)	19.7" (500 mm)	22.5" (572 mm)	15.6" (396 mm)	18.4" (467 mm)

Dim.	15/25 kV
E	4.0" (101 mm)
F	4.1" (102 mm)
G	3.0" (76 mm)
S7	0.75" (19 mm)
S9	3.4" (86 mm)
S10	6.2" (157 mm)
S11	7.2" (182 mm)

Configuration 1. Both feet turned out.
 Configuration 2. One foot turned out, the other in.
 Configuration 3. Both feet turned in.

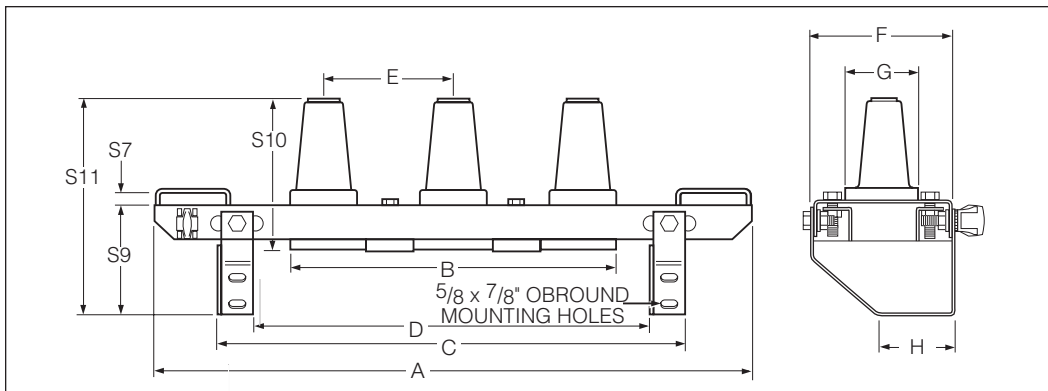

Deadbreak junction (35 kV shown)

TABLE 35 kV

Number of Interfaces	Physical Dimensions in. (mm)		Mounting Dimensions in. (mm)	
	A	B	C	D
2	21.5" (546 mm)	9.0" (229 mm)	15.5" (394 mm)	12.5" (318 mm)
3	27.5" (699 mm)	15.0" (381 mm)	21.5" (546 mm)	18.5" (470 mm)
4	33.5" (851 mm)	21.0" (533 mm)	27.5" (699 mm)	24.5" (622 mm)

Dim.	35 kV
E	6.0" (152 mm)
F	6.2" (158 mm)
G	3.0" (76 mm)
H	3.8" (96 mm)
S7	0.75" (19 mm)
S9	5.55" (141 mm)
S10	7.0" (178 mm)
S11	10.4" (264 mm)

Note: C and D are minimum and maximum stud centerline separations for mounting.

Junction bars/cable transition & oil stop modules

Eaton designs its Cooper Power series junction bars for vault or apparatus applications and can be used for looping, tapping, and sectionalizing.

Cable transition modules (CTMs) and oil stop modules (OSMs) are designed for splicing paper insulated lead cable (PILC) into solid dielectric cable.

Junction bars and cable transition modules are fully shielded, submersible, resistant to harsh materials, and are designed and manufactured in accordance with IEEE Std 386™ standard - "Separable Insulated connector Systems".

Junction bars and cable transition and oil stop modules are manufactured in 200 A, 600 A or 900 A configurations. The 200 A designs incorporate a universal bushing well design making it possible to use either a 200 A loadbreak or deadbreak bushing well insert.



Junction bar catalog numbering key

- "JBI" = Junction Bar, In-Line
- "JBL" = Junction Bar, "L" Splice
- "JBY" = Junction Bar, "Y" Splice
- "JBS" = Junction Bar, Stacked
- "25" = 15/25 kV Rating
- "35" = 35 kV Rating***
- "335" = Three-Phase, 35 kV Rating
- "U" = With U-Straps
- "PS" = Bracket with (2) Parking Stands
- "W" = 200 A Well
- "B" = 600 A Bushing
- "S" = 600 A Straight Interface Bushing
- "C" = Copper























Available Mounting Provisions

Junction Type	S.S. Mtg. Bracket 0-60° Mtg. Angles	Non-Adjustable S.S. Flush Mtg. Bracket	S.S. U-Straps*	S.S. Mtg. Bracket with (2) Parking Stands**
In-Line Junction Bar	Std.		Yes	Yes
Stacked Junction Bar		Std.	No	Yes
"L" Splice	Std.		Yes	Yes
"Y" Splice		Std.	No	No

* For U-straps add suffix U on the end of the standard catalog number.

** For Parking Stand Bracket add suffix PS on the end of the standard catalog number.

15/25 and 35 kV in-line junction bars with stainless steel bracket

Catalog Section	Description	kV Class	Base Part Number	Notes
CA650079EN				
	2 Point 200 A	15/25 kV 35 kV	JB125C2W JB135C2W	1,2
	3 Point 200 A	15/25kV 35 kV	JB125C3W JB135C3W	1,2
	4 Point 200 A	15/25kV 35 kV	JB125C4W JB135C4W	1,2
	5 Point 200 A	15/25kV 35 kV	JB125C5W JB135C5W	1,2
	6 Point 200 A	15/25kV 35 kV	JB125C6W JB135C6W	1,2
	2 Point 600/900 A*	15/25kV 35 kV	JB125C2B JB135C2B	1,2
	3 Point 600/900 A*	15/25kV 35 kV	JB125C3B JB135C3B	1,2
	4 Point 600/900 A*	15/25kV 35 kV	JB125C4B JB135C4B	1,2
	5 Point 600/900 A*	15/25kV 35 kV	JB125C5B JB135C5B	1,2
	6 Point 600/900 A*	15/25kV 35 kV	JB125C6B JB135C6B	1,2
	3 Point 1 x 200 A 2 x 600 A	15/25kV 35 kV	JB125C1W2B JB135C1W2B	1,2
	3 Point 1 x 600 A 1 x 200 A 1 x 600 A	15/25kV 35 kV	JB125C1B1W1B JB135C1B1W1B	1,2
	3 Point 2 x 200 A 1 x 600 A	15/25kV 35 kV	JB125C2W1B JB135C2W1B	1,2
	4 Point 1 x 200 A 3 x 600 A	15/25kV 35 kV	JB125C1W3B JB135C1W3B	1,2
	4 Point 2 x 200 A 2 x 600 A	15/25kV 35 kV	JB125C2W2B JB135C2W2B	1,2
	4 Point 3 x 200 A 1 x 600 A	15/25kV 35 kV	JB125C3W1B JB135C3W1B	1,2
	4 Point 1 x 600 A 2 x 200 A 1 x 600 A	15/25kV 35 kV	JB125C1B2W1B JB135C1B2W1B	1,2
	5 Point 1 x 200 A 4 x 600 A	15/25kV 35 kV	JB125C1W4B JB135C1W4B	1,2
	5 Point 2 x 200 A 3 x 600 A	15/25kV 35 kV	JB125C2W3B JB135C2W3B	1,2
	5 Point 4 x 200 A 1 x 600 A	15/25kV 35 kV	JB125C4W1B JB135C4W1B	1,2
	5 Point 1 x 600 A 3 x 200 A 1 x 600 A	15/25kV 35 kV	JB125C1B3W1B JB135C1B3W1B	1,2
	6 Point 3 x 200 A 3 x 600 A	15/25kV 35 kV	JB125C3W3B JB135C3W3B	1,2
	6 Point 1 x 600 A 4 x 200 A 1 x 600 A	15/25kV 35 kV	JB125C1B4W1B JB135C1B4W1B	1,2

1. For U-Straps, add "U" on end of catalog number.

2. For (2) parking stand brackets add "PS" to end of catalog number.

* A 900 A rating can be achieved when mated with comparably rated separable connectors.

15/25 kV and 35 kV L-splices and Y-splices with stainless steel brackets

1. for U-Straps, add "U" on end of catalog number.
2. For (2) parking stand brackets add "PS" to end of catalog number.

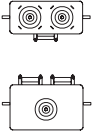
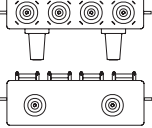
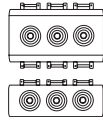
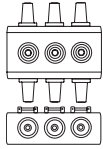
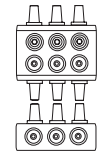
Catalog Section	Description	kV Class	Base Part Number	Notes
CA650079EN	L-SPLICES 15/25 AND 35 KV WITH STAINLESS STEEL BRACKETS			
	3 Point Single-Phase 2 x 200 A 1 x 200 A	15/25 kV 35 kV	JBL25C2W1W JBL35C2W1W	1, 2
	6 Point Single-Phase 4 x 200 A 2 x 600 A	15/25 kV 35 kV	JBL25C4W2B JBL35C4W2B	1, 2
CA650079EN	Y SPLICES, THREE-PHASE 15/25 KV WITH STAINLESS STEEL BRACKETS			
	9 Point Three-Phase 3 x 200 A Per Phase	15/25 kV 35 kV	JBY325C3W JBY335C3W	
	9 Point Three-Phase 2 x 600 A 1 x 200 A Per Phase	15/25 kV 35 kV	JBY325C1W2B JBY335C1W2B	
	12 Point Three-Phase 3 x 600 A 1 x 200 A Per Phase	15/25 kV 35 kV	JBY325C1W3B JBY335C1W3B	



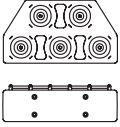
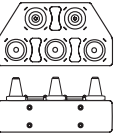
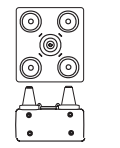
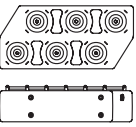
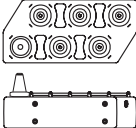
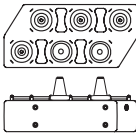
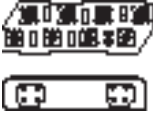

15/25 & 35 kV stacked junction bars with stainless steel brackets

1. For (2) parking stand brackets add "PS" to end of catalog number.

Catalog Section	Description	kV Class	Base Part Number	Notes
CA650079EN				
	5 Point 5 x 200 A	15/25 kV 35 kV	JBS25C2W3W JBS35C2W3W	1
	5 Point 2 x 200 A 3 x 600 A	15/25 kV 35 kV	JBS25C2W3B JBS35C2W3B	1
	5 Point 2 x 600 A 1 x 200 A 2 x 600 A	15/25 kV 35 kV	JBS25C2B1W2B JBS35C2B1W2B	1
	6 Point 6 x 200 A	15/25 kV 35 kV	JBS25C3W3W JBS35C3W3W	1
	6 Point 3 x 200 A 1 x 600 A 2 x 200 A	15/25 kV 35 kV	JBS25C3W1B2W JBS35C3W1B2W	1
	6 Point 3 x 200 A 1 x 200 A 2 x 600 A	15/25 kV 35 kV	JBS25C3W1W2B JBS35C3W1W2B	1
	8 Point 8 x 200 A	15/25 kV 35 kV	JBS25C4W4W JBS35C4W4W	1

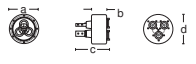
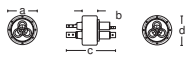
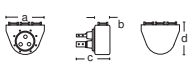
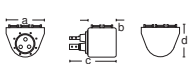
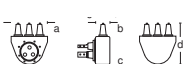
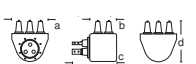
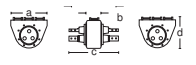
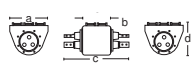
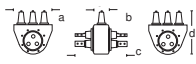
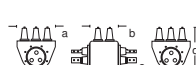
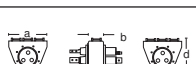
15 and 25 kV cable transition modules

1. Cable Lug Size required at time of order.

Catalog Section	Description	kV Class	Base Part Number	Notes
CA650080EN	STRAIGHT THROUGH			
	3 Point 200 A	15 kV and 25 kV	CTM005A	1
	3 Point 600 A	15 kV and 25 kV	CTM012A	1
CA650080EN	TAP			
	3 Point 200 A	15 kV and 25 kV	CTM015A	1
	6 Point 200 A	15 kV and 25 kV	CTM025A	1
	3 Point 600 A	15 kV and 25 kV	CTM011A	1
	6 Point 600 A	15 kV and 25 kV	CTM020A	1
CA650080EN	STRAIGHT THROUGH AND TAP			
	3 Point 200 A	15 kV and 25 kV	CTM010A	1
	6 Point 200 A	15 kV and 25 kV	CTM024A	1
	3 Point 600 A	15 kV and 25 kV	CTM009A	1
	6 Point 600 A	15 kV and 25 kV	CTM019A	1
	3 Point 200 A	15 kV and 25 kV	CTM029A	1
	3 Point 600 A	15 kV and 25 kV	CTM030A	1
CA650080EN	ACCESSORIES			
	Wiping Sleeve	15 kV and 25 kV	WS1112 WS1118	
	Wiping Flange	15 kV and 25 kV	WS12	

15 and 25 kV Cable Transition & Oil Stop Modules

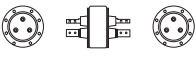
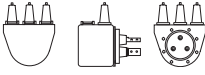
Catalog Section	Description	kV Class	Base Part Number	Notes
CA650080EN	MOUNTING BRACKET			
	Saddle	15 kV and 25 kV	BRK469	
CA650080EN	OIL STOP MODULES			
	Three-Phase 600 A PILC to PILC Splice	15 kV and 25 kV	OSM004	1
	Tap Transition, Paper Insulated Lead Cable (PILC) Run to 3 Point 200 A and 3 Point 600 A Tap	15 kV and 25 kV	CTM035A	1

1. Cable Lug Size required at time of order.

Splices

Eaton offers various types of splices for your underground needs on 200 A and 600 A systems. Eaton's Cooper Power series EZ II one-piece splices at 15, 25, and 35 kV include advantages for typical applications of repair, replacement, or extension of high voltage underground cables. These all peroxide-cured EPDM rubber splices provide a highly reliable, permanent, fully shielded, and submersible cable joint with a current rating equal to that of the mating cable. EZ II splices can be installed in conduit, direct buried or in vault applications. The EZ II splice line meets or exceeds all requirements of IEEE Std 404™-1993 standard.

We offer a full line of 600/900 A separable splice kits for application on feeder circuits. These use standard BOL-T type components along with a peroxide-cured EPDM rubber connecting plug that allows for installation of multiple way splices. Separable splices are used to splice multiple cables or to deadend a single cable. The splices are rated for 600 A (900 A ratings are available) and are suitable for the repair or extension of underground feeders. Separable splice kits meet or exceed the requirements of IEEE Std 386™-2006 standard.

EZ II splices

The EZ II one-piece splices offer a number of features and benefits, including:

Easiest to Install – The design features of the EZ II splice including the tapered cable entrance, smooth bore, relieved conductive insert, and reformulated rubber provide for easier field installation. EZ II splices have been shown to be 30% easier to install than other manufacturers' splices.

Wide Range Taking – The wide range taking cable entrances are sized to accept all common cable insulation diameters. The wider cable ranges increase installation flexibility.

Sure Grip – The contoured EZ II splice body provides an easy gripping location during installation.

Long Term Reliability – The EZ II splice has successfully passed all requirements of the IEEE Std 404™-1993 standard and our exclusive field-proven multi-stress test to show the long term reliability of the design.

EZ II splice specification information

To ensure you have the most reliable, economical, installation friendly premolded one-piece splice available, your specification for EZ II Splice should include:

- Manufactured in full compliance with all applicable IEEE Std 404™-1993 standard.
- Manufactured from peroxide-cured EPDM rubber.
- Tapered ribs of the inside diameter of the conductive insert.
- Molded in compression connector diameters.
- Conductive insert ends encapsulated with insulating rubber.

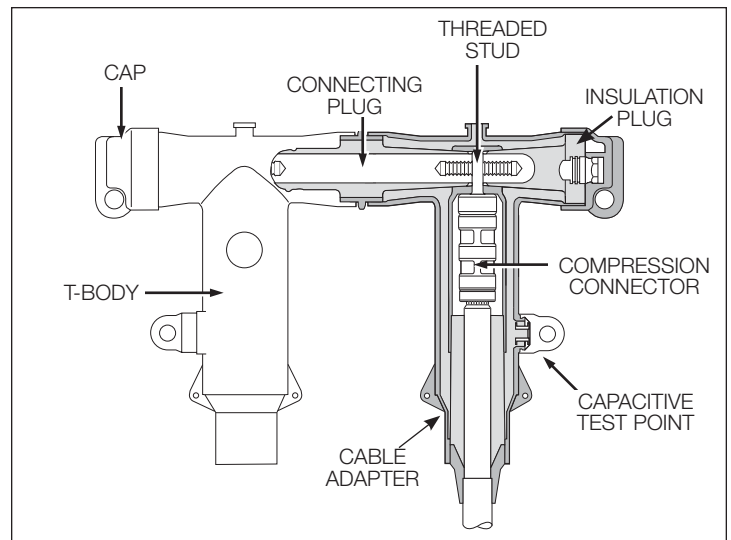

Typical components of a 600 A 2-way separable splice.

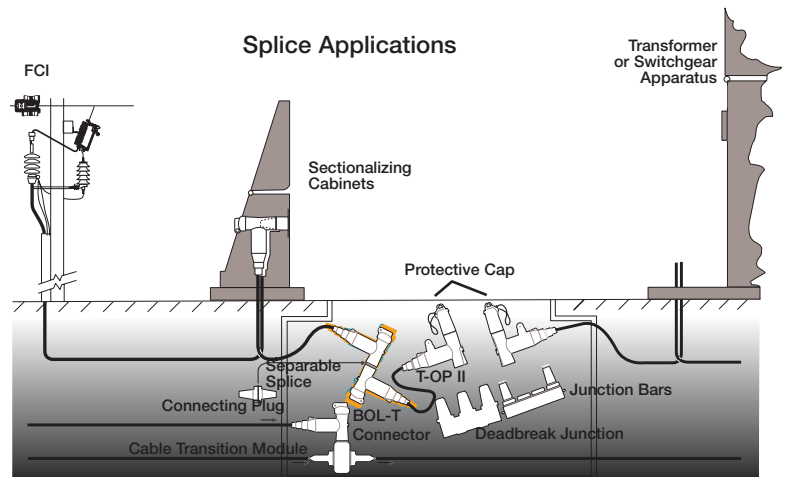

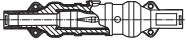
Catalog Section	Description	kV Class	Base Part Number	Notes
	EZ II Splice	15 kV	SP15 CR6 CC5 (see CR6 & CC5 Tables Below)	1, 2, 3, 4
		25 kV	SP25 CR6 CC5 (see CR6 & CC5 Tables Below)	1, 2, 3, 4
		35 kV	SP35 CR6 CC5 (see CR6 & CC5 Tables Below)	1, 2, 3, 4

CA650020EN

Use for Base Number (both tables)
SP15 SP25 SP35

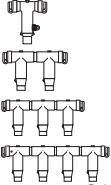

TABLE CR6 Cable Diameter (Insulation) Range

Cable Diameter Range		Voltage Class	Conductor Range	CABLE RANGE CODE
Inches	Millimeters			
0.640-0.910	16.3-23.1	15 kV	#3 str - 3/0 cmpct	A
0.750-1.010	19.1-25.7	15 & 25	#3 str - 3/0 cmpct	B
0.890-1.140	22.6-29.0	15 & 25	#3 str - 250 str	C
0.840-1.110	21.3-28.2	25 & 35	#3 str - 250 str	D
1.000-1.310	25.4-33.3			E
1.140-1.450	29.0-36.8	35	#3 str - 250 str	F

TABLE CC5 Conductor Size and Type

Stranded or Compressed		Compact or Solid		CONDUCTOR CODE
AWG	mm ²	AWG	mm ²	
#3	25	#2	35	001
#2	35	#1	-	002
#1	-	1/0	50	003
1/0	50	2/0	70	004
2/0	70	3/0	-	005
3/0	-	4/0	95	006
4/0	95	250	120	007
250*	120	-	-	008

* Compressed stranding only





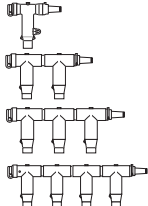
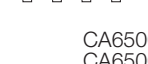











	600 A Separable Splices (Kits Do Not Include Cable Adapters or Compression Connector. Refer to 600 A Replacement Parts Page 25)	15/25 kV Deadend Kit	SSPL625A1	5, 6, 7, 8
		2-way Splice Kit	SSPL625A2	5, 6, 7, 8
		3-way Splice Kit	SSPL625A3	5, 6, 7, 8
		4-way Splice Kit	SSPL625A4	5, 6, 7, 8
	600 A Separable Splices with 200 A Tap (Kits Do Not Include Required Threaded and Unthreaded Compression Connectors or Cable Adapters. Refer to 600 A Replacement Parts Page 25)	35 kV Deadend Kit	SSPL635A1	5, 6, 7, 8
		2-way Splice Kit	SSPL635A2	5, 6, 7, 8
		3-way Splice Kit	SSPL635A3	5, 6, 7, 8
		4-way Splice Kit	SSPL635A4	5, 6, 7, 8

CA650051EN
CA650050EN

	T-OP II 600 A Separable Splices with 200 A Tap (Kits Do Not Include Required Threaded and Unthreaded Compression Connectors or Cable Adapters. Refer to 600 A Replacement Parts Page 25)	15 kV T-OP II Deadend Kit	SSPLT615A1	5, 6, 7, 8, 9
		T-OP II 2-way Splice Kit	SSPLT615A2	5, 6, 7, 8, 9
		T-OP II 3-way Splice Kit	SSPLT615A3	5, 6, 7, 8, 9
		T-OP II 4-way Splice Kit	SSPLT615A4	5, 6, 7, 8, 9
	T-OP II 600 A Separable Splices with 200 A Tap (Kits Do Not Include Required Threaded and Unthreaded Compression Connectors or Cable Adapters. Refer to 600 A Replacement Parts Page 25)	25 kV T-OP II Deadend Kit	SSPLT625A1	5, 6, 7, 8, 9
		T-OP II 2-way Splice Kit	SSPLT625A2	5, 6, 7, 8, 9
		T-OP II 3-way Splice Kit	SSPLT625A3	5, 6, 7, 8, 9
		T-OP II 4-way Splice Kit	SSPLT625A4	5, 6, 7, 8, 9
	T-OP II 600 A Separable Splices with 200 A Tap (Kits Do Not Include Required Threaded and Unthreaded Compression Connectors or Cable Adapters. Refer to 600 A Replacement Parts Page 25)	35 kV T-OP II Deadend Kit	SSPLT635A1	5, 6, 7, 8, 9
		T-OP II 2-way Splice Kit	SSPLT635A2	5, 6, 7, 8, 9
		T-OP II 3-way Splice Kit	SSPLT635A3	5, 6, 7, 8, 9
		T-OP II 4-way Splice Kit	SSPLT635A4	5, 6, 7, 8, 9

CA650051EN
CA650050EN

TABLE 4
Separable Splice Kits

Assembly	Splice Kit Contents					Order Separately (Refer to pg 25)		
	 T-Body	 Insulating Plug w/Cap	 Insulating Plug w/Cap and Stud	 Connecting Plug w/Stud	 Loadbreak Reducing Tap Plug (Includes STUD-T)	 Cable Adapter	 Unthreaded Compression Connector	 Threaded Coppertop Connector
 Deadend	1	1	1	-	-	1	1	-
 2-Way Splice	2	1	1	1	-	2	2	-
 3-Way Splice	3	1	1	2	-	3	3	-
 4-Way Splice	4	1	1	3	-	4	4	-
 T-OP II Deadend	1	1	-	-	1	1	-	1
 T-OP II 2-Way Splice	2	1	-	1	1	2	1	1
 T-OP II 3-Way Splice	3	1	-	2	1	3	2	1
 T-OP II 4-Way Splice	4	1	-	3	1	4	3	1

BR100003EN

- For an **all copper connector**, change digit six from a "0" to a "C".
- For a **splice with a single-piece** re-jacketing kit, insert a "S" or a **2-piece** re-jacketing kit, insert a "D" as the ninth character in the part number.
- For **individually packaged** product in a corrugated cardboard box, insert an "X" as the last character in the part number.
- To splice different sized cables, refer to transition splice information in catalog section CA650020EN.
- For **900 A rating** (copper components) replace the "A" with a "C".
- For T-bodies with **test points**, insert a "T" directly after the base part number.
- Studs are bagged and loose in kit. To have **studs permanently installed** at the factory, add a "P" after the test point designation (if applicable) or after the base part number.
- Installation requires a standard 5/16" hex key (HD625).
- To include **200 A loadbreak protective cap**, add a "C" as the last character in the part number.

Underground surge arresters

Eaton provides shielded deadfront arrester protection with its Cooper Power series metal oxide varistor elbow (M.O.V.E.) and parking stand arresters used in pad-mounted transformer and entry cabinets, vaults, switching enclosures and other installations. These arresters are designed for use with 200 A loadbreak interfaces to limit overvoltages to acceptable levels, protect equipment and extend cable life.

POSI-BREAK M.O.V.E. elbow arrester

The POSI-BREAK M.O.V.E. arrester provides the same safety benefits of the POSI-BREAK connector system with over-voltage protection. Eaton is the only manufacturer to offer a solution to the partial vacuum flashover in elbow arresters.

The POSI-BREAK M.O.V.E. arrester is available for 9-21 kV for 25 kV class interfaces.

M.O.V.E. DirectConnect elbow arrester

M.O.V.E. DirectConnect elbow arresters are used on underground systems in pad-mounted transformer and entry cabinets, vaults, switching enclosures and other installations to provide shielded deadfront arrester protection. They are designed for use with 600 A, 35 kV Class deadbreak interfaces that conform to IEEE Std 386™ standard to limit overvoltages to acceptable levels, protect equipment and extend cable life.



M.O.V.E. DirectConnect elbow arrester specification information

Design Tests

- IEEE Std 386™ standard, Separable Insulated Connector Systems
- IEEE Std C62.11 standard, Metal Oxide Surge Arresters for AC Power Circuits



DirectConnect elbow arrester.

TABLE 1
Commonly Applied Voltage Ratings of M.O.V.E. and Parking Stand Arresters

System Voltage (V rms)		Commonly Applied Arrester Duty-cycle (MCOV) Voltage Rating (kV rms) on Distribution Systems		
Nominal Voltage	Maximum Voltage	4-Wire Multigrounded Neutral Wye	3-Wire Low Impedance Grounded	Delta and 3-Wire High Impedance Grounded
2400	2540	–	–	3 (2.55)
4160 Y/2400	4400 Y/2540	3 (2.55)	6 (5.1)	6 (5.1)
4260	4400	–	–	6 (5.1)
4800	5080	–	–	6 (5.1)
6900	7260	–	–	9 (7.65)
8320 Y/4800	8800 Y/5080	6 (5.1)	9 (7.65)	–
12000 Y/6930	12700 Y/7330	9 (7.65)	12 (10.2)	–
12470 Y/7200	13200 Y/7620	9 (7.65) or 10 (8.4)	15 (12.7)	–
13200 Y/7620	13970 Y/8070	10 (8.4)	15 (12.7)	–
13800 Y/7970	14520 Y/8388	10 (8.4) and 12 (10.2)	15 (12.7)	–
13800	14520	–	–	18 (15.3)
20780 Y/12000	22000 Y/12700	15 (12.7)	21 (17.0)	–
22860 Y/12000	22000 Y/12700	15 (12.7)	21 (17.0)	–
24940 Y/14400	26400 Y/15240	18 (15.3)	27 (22.0)	–
27600 Y/15935	29255 Y/16890	21 (17.0)	–	–
34500 Y/19920	36510 Y/21080	27 (22.0) or 30 (24.4)	–	–
46000 Y/26600	48300 Y/28000	36 (29.0)	–	–

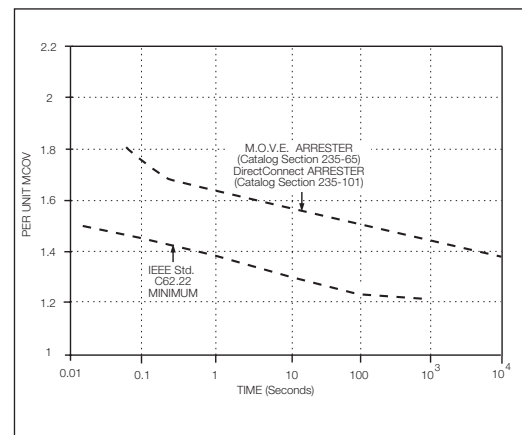

Temporary overvoltage curve. No prior duty at 85° C ambient.

The following notes apply to all part numbers on this page.

■ Digits 9 & 10 designate duty cycle voltage rating. For other protective characteristics, refer to Table 2 for M.O.V.E. and Parking Stand Arresters and Table 3 for DirectConnect elbow arresters.

■ Refer to page 17 for dimensional information or referenced catalog section.



Catalog Section	Description	kV Class	Base Part Number	MCOV (kV)
	Metal Oxide Elbow (M.O.V.E.) Arrester	15 kV	3238018C03M	2.55
			3238018C06M	5.1
			3238018C09M	7.65
			3238018C10M	8.4
			3238018C12M	10.2
			3238018C15M	12.7
		3238018C18M	15.3	
		25 kV	3238019C09M	7.65
			3238019C10M	8.4
			3238019C12M	10.2
	3238019C15M		12.7	
	25 kV POSI-BREAK Elbow Arrester	25 kV POSI-BREAK Elbow Arrester	PLEA225N03	2.55
			PLEA225N06	5.1
			PLEA225N09	7.65
			PLEA225N10	8.4
			PLEA225N12	10.2
			PLEA225N15	12.7
	35 kV (Interface 1A Large Interface per IEEE Std 386™ -2006 standard)	35 kV (Interface 1A Large Interface per IEEE Std 386™ -2006 standard)	3238020C18M	15.3
			3238020C21M	17.0
			3238020C24M	19.5
3238020C27M			22.0	
3238020C30M			24.4	
3238020C33M			27	
3238020C36M			29	
CA235025EN				
	Metal Oxide (MOV) Parking Stand Arrester	15 kV	3237686C03M	2.55
			3237686C06M	5.1
			3237686C09M	7.65
			3237686C10M	8.4
			3237686C12M	10.2
			3237686C15M	12.7
			3237686C18M	15.3
	25 kV	3237758C09M	7.65	
		3237758C10M	8.4	
		3237758C12M	10.2	
		3237758C15M	12.7	
		3237758C18M	15.3	
		3237758C21M	17.0	
		CA235027EN		
	M.O.V.E. DirectConnect Elbow Arrester	35 kV	DCEA635M27	22.0
			DCEA635M30	24.4
			DCEA635M33	27.0
			DCEA635M36	29.0
			CA235026EN	

TABLE 2
M.O.V.E. and Parking Stand Arrester Protective Characteristics

Duty Cycle Voltage Rating (kV)	MCOV (kV)	Equivalent Front-of-Wave (kV crest)*	Maximum Discharge Voltage (kV crest) 8/20 μs Current Wave				
			1.5 kA	3 kA	5 kA	10 kA	20 kA
3	2.55	11	9	9.7	10.7	11.4	13
6	5.1	22	18.0	19.4	20.8	22.7	26
9	7.65	31.7	26	28	30	32.8	37.4
10	8.4	33	27	29.1	31.2	34.1	38.9
12	10.2	41.5	33.9	36.6	39.2	42.9	48.9
15	12.7	51.8	42.4	45.7	49	53.6	61.1
18	15.3	62.2	50.9	54.9	58.8	64.3	73.4
21	17.0	66	54.0	58.2	62.4	68.2	77.9
24	19.5	77	63.0	67.9	72.8	79.6	90.8
27	22.0	87.2	71.4	76.9	82.4	90.1	103
30	24.4	97.1	79.5	85.7	91.8	100.0	115.0
33	27	108	87.8	95.1	102	112	127
36	29	116	95.3	103	110	120	137

* Equivalent front-of-wave voltage is the expected discharge voltage of the arrester when tested with a 5 kA current surge cresting in 0.5 μs.

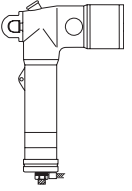
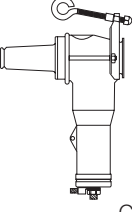
TABLE 3
M.O.V.E. DirectConnect Elbow Arrester Electrical Ratings and Characteristics

Duty Cycle Voltage Rating (kV)	MCOV (kV)	Front-of-Wave Protective Level* (kV crest)	Maximum Discharge Voltage 8/20 μs Current Wave (kV crest)				
			1.5 kA	3 kA	5 kA	10 kA	20 kA
27	22.0	105.0	75.0	82.0	87.4	96.2	110.0
30	24.4	112.0	79.5	85.7	91.8	100.0	115.0
33	27	108	87.8	95.1	102	112	127
36	29	116	95.3	103	110	120	137

* Equivalent front-of-wave voltage is the expected discharge voltage of the arrester when tested with a 5 kV current surge cresting in 0.5 μs.

Tools & maintenance

Eaton's Cooper Power series Kearney operation offers a wide variety of Hi-Line™ tools and maintenance equipment including Insulated sticks, Fit-On™ tools, tree trimmers, fuse pullers, cover-up equipment, jumpering/grounding equipment, compression tools, cutters and accessories.

Kearney also offers a wide range of connectors. Products include:

- Aqua Seal™ and Airseal™ insulating and sealing material
- Compression Squeezon™ connectors, tee-taps, stirrups, terminals, grounding lugs, spacers
- Secondary terminal connectors, and a wide variety of sleeves



















O-Tool Dies		WH2, WH3, WH4, BH4, PH2 & PH13 Dies		PH4, PH15 & RH15 Dies	
Catalog Number		Catalog Number		Catalog Number	
30554CPS	B	36457	D	100472CPS	D
26994	D	36459**	N	100473CPS	N
48410	J	36467*	O	100474	U
40495CPS	K	36472	U	100057	R
26993	O	36474*	15/16	100470CPS	1-2
30611CPS	P	36476*	840	100471CPS	1-1/8-2
40493CPS	T	36478*	781	100440CPS	1-5/16
30084	737	36480*	737	100460CPS	1-1/2
30450	781	36482CPS*	635	100459	1-5/8
30124	840	36484CPS*	5/8-1	100075CPS	1-3/4
36181CPS	3/16	36486CPS*	19/32	100096CPS	Adapter
30154	1/4	36488*	9/16	PH25 DIES	
30043	5/16	36490CPS*	1/2	100006-16	1- 1/8-1
30042	3/8	36494CPS*	3/8	100006-7	727
30041	1/2	36496*	5/16	100006-12	840
26958	9/16	36498*	1/4	100006-15	1 (Hex)
30914	19/32	36828CPS*	P	100007-1	1 9/32 (Hex)
26992CPS	5/8-1	36830CPS	C	100007-3	1 1/2 (Hex)
40114CPS	11/16	36832CPS*	B-K-T	100007-4	1 5/8 (Hex)
Non-Bow Dies		36834CPS*	747	100007-6	1 3/4 (Hex)
100625CPS	500	36836*	572	100007-9	2 1/8 (Hex)
100600CPS	510	36838*	510	100007-23	R
100613	620	40063*	727		
100601	635	40151CPS*	11/16		
100618CPS	702	40517	1 1/4 (Hex)		
100602	747	49435*	3/4 (Hex)		
100609	845	49437*	29/32 (Hex)		
100606	980	100370CPS	15/16 (Hex)		
EEl Dies		100399	1-2 (Hex)		
100603-7	7A	100400	1 1/8-2 (Hex)		
100603-9	9A	100433CPS	1 5/16 (Hex)		
100603-11	11A	100434CPS	1 1/2 (Hex)		
Other Dies & Accessories		100455	9/16 Wide		
30744	BU-C	100456	840 Wide		
49341	Orange				
36559	Plum				
Wire Cutter Die for 2/0 ACSR Max					
30500CPS					

* These dies may be used with adapter #100096 in PH3, PH4 and PH14 tools.

** For WH3 tool, use 36469-3

The following are Non Bow equivalents of standard dies:
737→747, 840→845,
1/2→500, 5/8-1→620

Cases for O-Tools			
For Tool Model	Description	Catalog Number	Net Wt. Each
O-60 Series	Die Case	30642CPS	1 lb.

Catalog Section	Description	kV Class	Base Part Number	Notes
CA325006EN	 TYPE "OS" TOOLS 5/8 Fixed Die		OS50	
	 620 Fixed Die		OS-620	
CA325006EN	 TYPE O-62 TOOLS 5/8" FIXED NOSE DIE 17" Straight Handles – Non-Insulated Head		O-62F	1, 4, 8
	 21" Straight Handles – Non-Insulated Head		O-62-21F	2, 4, 8
	 17" Bent Handles – Non-Insulated Head		O-62-50F	3, 4, 8
	 TYPE O-63 TOOLS WITH FIXED "O" NOSE DIE 17" Straight Handles – Non-Insulated Head		O-63F	4, 5, 8
CA325006EN	 21" Straight Handles – Non-Insulated Head		O-63-21F	2, 4, 8
	 17" Bent Handles – Non-Insulated Head		O-63-50F	3, 4, 8
	 TYPE O-620 TOOLS WITH FIXED 620 NOSE DIE 17" Straight Handles – Non-Insulated Head		O-620F	4, 7, 8
CA325006EN	 21" Straight Handles – Non-Insulated Head		O-620-21F	2, 4, 8
	 17" Bent Handles – Non-Insulated Head		O-620-50F	3, 4, 8
CA325006EN	 TYPE O-65 TOOLS WITH FIXED 5/8" AND "D" DIE 17" Straight Handles – Non-Insulated Head		O-65FB	8, 9
	 21" Straight Handles – Non-Insulated Head		O-65-21FB	2, 8
	 17" Bent Handles – Non-Insulated Head		O-65-50FB	3, 8
CA325006EN	 TYPE O-68 TOOLS WITH FIXED "O" AND "D" DIE 17" Straight Handles – Non-Insulated Head		O-68FB	8, 10
	 21" Straight Handles – Non-Insulated Head		O-68-21FB	2, 8
	 17" Bent Handles – Non-Insulated Head		O-68-50FB	3, 8
CA325006EN	PH13 SERIES 12-TON REMOTE HYDRAULIC TOOL 12 Ton, 4,000 PSI Remote Hydraulic Tool w/Case – 13" length		PH13-4	11

1. For an **insulated head**, insert a "-3" between the "2" and the "F".
Example: 0-62-3F.
2. For an **insulated head**, replace the "1" with a "2".
3. For an **insulated head**, replace the "50" with a "53".
4. To include "D" insert die, add a "B" as the last character in the part number.
5. For an **insulated head**, insert a "-3" between the "3" and the "F".
Example: 0-63-3F.
6. Consult customer service for availability.
7. For an **insulated head**, insert a "-3" between the "0" and the "F".
Example: 0-620-3F.
8. Accepts Burndy® Type "W" dies.
9. For an **insulated head**, insert a "-3" between the "5" and the "F".
Example: 0-65-3FB.
10. For an **insulated head**, insert a "-3" between the "8" and the "F".
Example: 0-68-3FB.
11. For **tool without case**, insert a "K" as the first character in the part number.

Catalog Section	Description	kV Class	Base Part Number	Notes
Hand Operated Cutters				
	General Purpose Center Cut		0190FC 0113C (Cutter Head)	
	Heavy-Duty		0290MCX 0213CX (Cutter Head)	
	Ratchet – Type Soft Cable		8690FSK 8613FSK (Cutter Head)	
	Ratchet – Type Hard Cable		8690FH 8613FH (Cutter Head)	
	Ratchet – Type Guy Strand		8690CK 8613CK (Cutter Head)	
	Ratchet – Type Wire Rope		8690TN 8613TN (Cutter Head)	
	ACSR Wire Rope and Cable		0290FHJ	
	Shear – Type Hand Operated		0290FCS 0213CSS (Cutter Head)	
	Compact Electric Cable		0890CSJ	
CA325006EN	Compact Ratcheting Cable		6990FHL	
CLAMPSTICKS				
	Clampstick		See Table 1	
	Clampstick, Cam-EL™		See Table 1	
	Clampstick, Hinged		See Table 1	
CA325005EN	Clampstick Leverage Tool		CS125UFLTOOL	



18" Fit-On Leverage tool provides mechanical advantage during loadbreak switching.

Note: Use external rod clampsticks only.

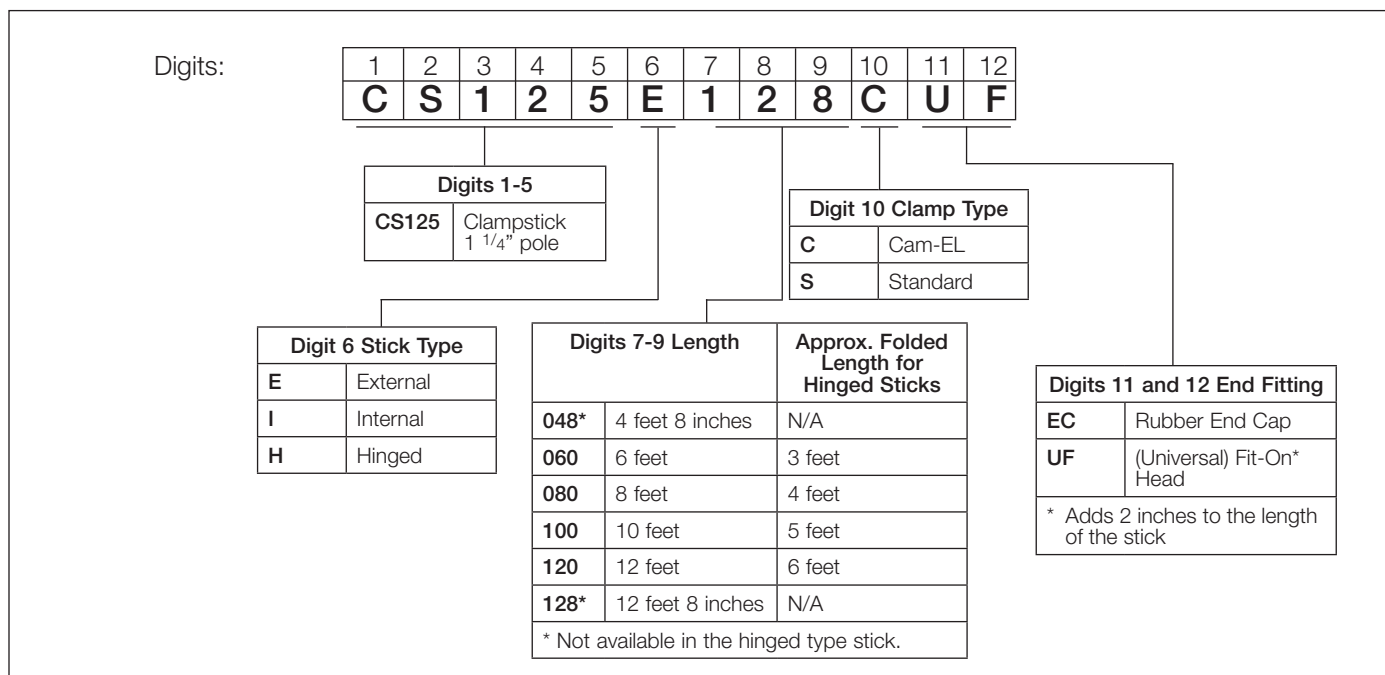

TABLE 1. Clampstick Significant Digit Catalog Number System



Catalog Section	Description	kV Class	Base Part Number	Notes
Temporary Grounding Sets				
	Single-Phase Three-Clamp Set Pad-mounted		133040 (1/0 Black Cable)	
	Three-Phase Four-Clamp Set Pad-mounted		133040-1 (1/0 Black Cable) 133040-2 (2/0 Black Cable)	
	Single Replacement Clamp for 1/0 Cable		133045CPS	
TD325001EN	Single Replacement Clamp for 2/0 Cable		133045Z20	
GROUNDING ELBOWS				
	Grounding Elbow	15 kV	GE215-1Y06-1/0 Cable GE215-2Y06-2/0 Cable	1
		25 kV	GE225-1Y06-1/0 Cable GE225-2Y06-2/0 Cable	1
		35 kV	GE235-1Y06-1/0 Cable GE235-2Y06-2/0 Cable	1
TD325001EN				
	Grounding Kit	15 kV	GE215-1Y06-K1	2
			GE215-2Y06-K1	3
			GE215-1Y06-K3	4
			GE215-2Y06-K3	5
		25 kV	GE225-1Y06-K1	2
			GE225-2Y06-K1	3
35 kV	GE225-1Y06-K3	4		
	GE225-2Y06-K3	5		
TD325001EN		GE235-1Y06-K1	2	
		GE235-2Y06-K1	3	
INSULATING AND SEALING MATERIALS				
Aqua Seal				
	3 3/4" x 3 3/4" Pads – 25 per Box		104742-2	6
	3 3/4" x 10' Roll		104742	6
Air Seal				
325-24	4" x 4" Pads – 25 per Box		18415-8	6
	4" x 10' Roll		18415-3	6
KEARNALEX™ INHIBITOR				
Specification 118 (Non-Petroleum Base)				
	4 oz. Plastic Dispenser Bottle		30584-25	
	8 oz. Plastic Dispenser Bottle		30584-3	
	8 oz. Plastic Dispenser Bottle – Gritless		30584-30	
CONDUCTOR CLEANING BRUSHES				
	Hand Element and Replacement Brush for Fit-On Head – 477 kcmil ACSR MAX		48900	
	Hand Element and Replacement Brush for Fit-On Head– 954 kcmil ACSR MAX		48900-2	
	V-Brush with Handle and Guard		118004	
325-30	Single Replacement Brush for V-Brush		19100	

1. Clamp and ferrule are not included with the grounding elbow.
2. Single kit with (1) elbow with 1/0 cable, (1) portable feedthru, (1) protective cap and (1) test probe in a carrying bag.
3. Single kit with (1) elbow with 2/0 cable, (1) portable feedthru, (1) protective cap and (1) test probe in a carrying bag.
4. Triple kit with (3) elbows with 1/0 cable, (3) portable feedthrus, (3) protective caps and (1) test probe in a carrying bag.
5. Triple kit with (3) elbows with 2/0 cable, (3) portable feedthrus, (3) protective caps and (1) test probe in a carrying bag.
6. Other material sizes available.

Bushings

Eaton has a full line of one-piece bushings, bushing wells, bushing well inserts, and feed-thru inserts in its Cooper Power series products for installation on transformers and/or sectionalizing cabinets. The 15 kV and 25 kV class bushing inserts use a knurled piston providing maximum copper-to-copper current transfer and maximum thermal stability. After fault close operation, it locks the piston in the outward position, providing a visible indication against dangerous repetitive fault closure.

Type Primary Bushings	Current Rating (A)	Voltage Rating (kV)
Bushing wells	200	15, 25, 35
Integral loadbreak bushing 3Ø rated	200	35
Deadbreak apparatus bushing	600	15/25, 35
Deadbreak PUSH-OP Apparatus Bushing	600	15/25, 35



200 A integral loadbreak bushing specification information

- 200 A, 35 kV three-phase rated integral loadbreak bushing meeting the requirements of IEEE Std 386™ standard No. 1A (large 35 kV class interface).
- Voltage and current ratings in accordance with IEEE Std 386™ standard.





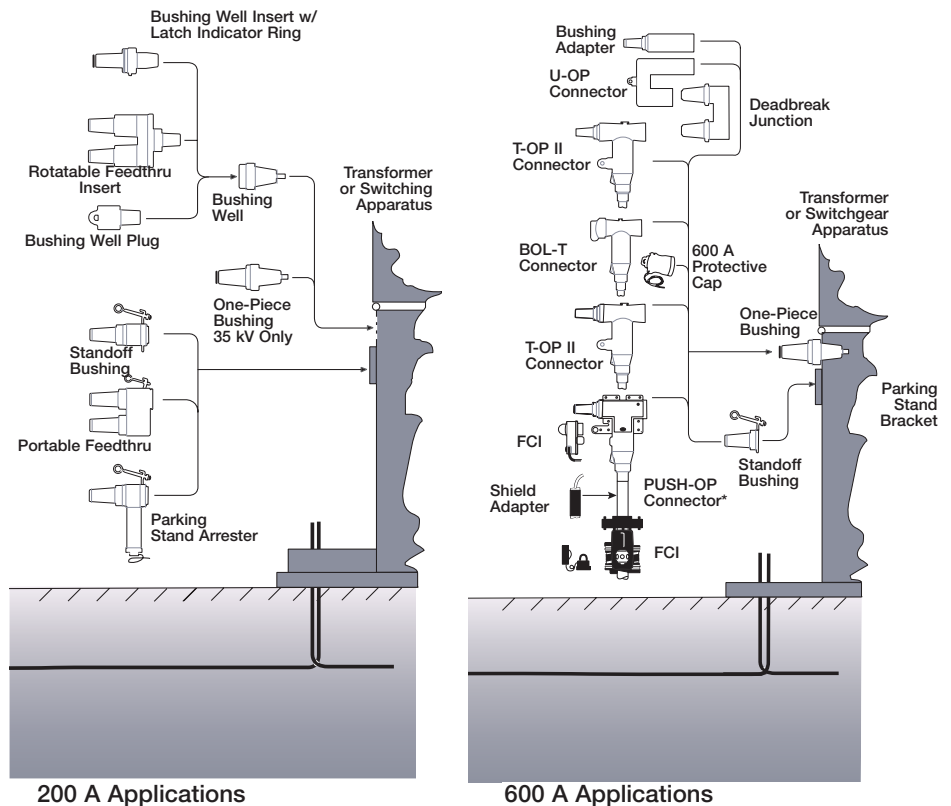

600 A PUSH-OP deadbreak bushing specification information

- 600 A deadbreak apparatus bushing shall be compatible with 600 A PUSH-OP connectors.
- Complete with plated copper finger contacts to accept PUSH-OP probe, to achieve a non-bolted connection.
- Voltage and current ratings in accordance with IEEE Std 386™ standard.

200 A HTN Tri-Clamp bushing well specification information

- Molded-in semi-conductive shield.
- 35 kV, 150 kV BIL.
- HTN material.
- Removable stud shall have provisions for easy removal of broken parts from both the bushing well and insert.
- Voltage and current ratings in accordance with IEEE Std 386™ standard.

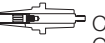

Catalog Section	Description	kV Class	Base Part Number	Notes
 CA800016EN	200 A Plastic (HTN) TRI-Clamp Bushing Well 2 9/16" Dia Hole Size	15/25/35 kV	BW150F (with fixed stud) BW150R (with removable stud)	2
 CA800014EN	200 A Plastic (HTN) Bushing Well 2 9/16" Dia.Hole Size	15/25/28 kV	2638372C01 (with fixed stud) 2638372C02R (with removable stud)	1, 2, 5 1, 2, 5
 CA800015EN	200 A Epoxy Bushing Well 2 9/16" Dia.Hole Size	15/25/28 kV	2603973B02T (with fixed stud) 2603973B02R (with removable stud)	1, 2 1, 2
 CA800021EN	200 A Three-Phase Integral Loadbreak Bushing	35 kV	2637024C01M (Externally Clamped – 2 3/4")	3
	600 A Deadbreak Bushing (Externally Clamped without Stud)	15/25 kV	2637019B02 (Aluminum)	3
		15/25 kV	2637019B04 (Copper)	3
		35 kV	DB635B150 (150 kV BIL) DB635B200 (200 kV BIL) (Aluminum) (2 9/16")	3
		35 kV	DB935B150 (150 kV BIL) DB935B200 (200 kV BIL) (Copper) (2 9/16")	3
	600 A Deadbreak PUSH-OP Bushing (Externally Clamped)	15/25 kV	2637604C01 (2 9/16")	4
		35 kV	DB635B150P	4
	3-STUD CLAMPS			
	4,688 B.C. w/flange 4 Bail Tabs	15/25/35 kV	2085399A01 2085399A02 (Stainless Steel)	
	4-STUD CLAMPS			
	3.25 C-C	15/25/28 kV	2606821A01	
	3.25 C-C 2 Bail Tabs	15/25/28 kV	2606823A02	
	3.25 C-C 4 Bail Tabs	15/25/28 kV	2606823A04	
	3.90 C-C	35 kV	2603989B01	
	3.43 C-C (600 A)	15/25/35 kV	2637023B01	
	2 9/16" Dia. Hole Gasket	15/25/28/35 kV	0537980C22	
	2 9/16" Dia. Hole Gasket	15/25 kV	0537980C07	
	2 3/4" Dia. Hole Gasket	35 kV	0537980C12	
	2 9/16" Dia. Hole Gasket	15/25/35 kV	0537980C06	
	Red Shipping Cap	15/25/35 kV	2638640C01	
	Red Shipping Cap	35 kV	2606754A03	
	Red Shipping Cap	15/25 kV	2637700B02	
	Red Shipping Cap	35 kV	2610082P01	
	Red Shipping Cap	35 kV	2610082P01	
	Removable Stud (Well) Replacement Kit	15/25/28/35 kV	2639081B01B	
	Removable Threaded Stud (600 A Bushings)	15/25 kV	STUD-A (Aluminum) STUD-C (Copper)	
		35 kV	STUD635-A (Aluminum) STUD635-C (Copper)	
	Contact Tube Assembly	35 kV	2637407B03B	
	Contact Tool Replacement Tool	35 kV	2637585B01	
	PUSH-OP Bail Bracket Assembly	15/25/35 kV	2638772B03M	6
	PUSH-OP Bracket Alignment Fixture	15/25/35 kV	2637904C01	
	Grounding tab	15/25/35 kV	0739658A02	

1. Clamp must be ordered separately.
2. Bushing includes gasket and shipping cap.
3. Clamp and gasket must be ordered separately.
4. Clamp, gasket and bracket assembly must be ordered separately.
5. For **35 kV (150 kV BIL)** add "S" to end of the part number.
6. Latch handle standard on left side. For **latch handle on right side**, change digit 10 from a "3" to a "5".

Eaton offers Cooper Power series fuses under multiple trade names: Cooper, Kearney, McGraw-Edison and Combined Technologies™. We have the broadest range of overcurrent protective devices to meet your application needs.

Bay-O-Net fuse assembly

In the late 1960s, we introduced the Bay-O-Net assembly and links to the industry for pad-mounted transformer protection. The Bay-O-Net fuse has grown into the industry standard protection package for single- and three-phase transformers. The assembly combines the ease of hotstick operation with the safety of deadfront construction and is used with an isolation link to prevent line personnel from closing into a fault when replacing a blown Bay-O-Net link. Alternately, a back-up, current-limiting fuse can be used in place of the isolation link to increase interrupting ratings to 50 kA.



Flapper™ valve Bay-O-Net assembly specification information

- Bay-O-Net assembly shall include a valve that will shut when the inner holder is removed from the housing and minimize oil from spilling out of the Bay-O-Net assembly.

TransFusion™ coordination program







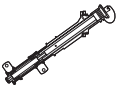

This free, web-based, easy-to-use coordination tool makes transformer protective device selection for pad-mounted transformers effortless. By simply inputting a few pieces of data and selecting the desired level of protection, you can quickly find the right Eaton product within its Cooper Power series fuse product line, whether its the ELSP fuse, Bay-O-Net fuse, or MagneX interrupter suitable for your application. The TransFusion coordination program provides you the flexibility of trying various combinations before deciding on the one that best fits your application needs. A simple click of the print button allows you to print your TCC curves and part numbers.

Go to this site for your coordination program
www.coopertransfusion.com.

TABLE 1
ELSP Fuse* Combinations

Voltage (kV)	Current Rating (A)	ELSP Part Numbers	Description
8.3	30	CBUC08030C100	8.3 kV 30 A
	40	CBUC08040C100	8.3 kV 40 A
	50	CBUC08050C100	8.3 kV 50 A
	65	CBUC08065C100	8.3 kV 65 A
	80	CBUC08080C100	8.3/9.9 kV 80 A
	100	CBUC08100C100	8.3/9.9 kV 100 A
	125	CBUC08125C100	8.3 kV 125 A
	150	CBUC08150D100	8.3 kV 150 A
	165	CBUC08165D100	8.3 kV 165 A
	180	CBUC08180D100	8.3 kV 180 A
9.9	250	CBUC08250D100	8.3 kV 250 A
	30	CBUC09030C100	9.9 kV 30 A
	40	CBUC09040C100	9.9 kV 40 A
	50	CBUC09050C100	9.9 kV 50 A
	65	CBUC09065C100	9.9 kV 65 A
15.5	30	CBUC15030C100	15.5 kV 30 A
	40	CBUC15040C100	15.5 kV 40 A
	50	CBUC15050C100	15.5 kV 50 A
	65	CBUC15065C100	15.5 kV 65 A
	80	CBUC15080C100	15.5/17.2 kV 80 A
	100	CBUC15100C100	15.5/17.2 kV 100 A
	125	CBUC15125C100	15.5/17.2 kV 125 A
	150	CBUC15150D100	15.5 kV 150 A
17.2	165	CBUC15165D100	15.5 kV 165 A
	180	CBUC15180D100	15.5 kV 180 A
	30	CBUC17030C100	17.2 kV 30 A
	40	CBUC17040C100	17.2 kV 40 A
23	50	CBUC17050C100	17.2 kV 50 A
	65	CBUC17065C100	17.2 kV 65 A
	30	CBUC23030C100	23 kV 30 A
	40	CBUC23040C100	23 kV 40 A
	50	CBUC23050C100	23 kV 50 A
	65	CBUC23065C100	23 kV 65 A
	80	CBUC23080C100	23 kV 80 A
	100	CBUC23100C100	23 kV 100 A
	125	CBUC23125D100	23 kV 125 A
38	150	CBUC23150D100	23 kV 150 A
	165	CBUC23165D100	23 kV 165 A
	50	CBUC38050D100	38 kV 50 A
	65	CBUC38065D100	38 kV 65 A
	80	CBUC38080D100	38 kV 80 A
	100	CBUC38100D100	38 kV 100 A
38	120	CBUC38120D100	38 kV 120 A
	140	CBUC38140D100	38 kV 140 A

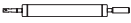
* Catalog CA132013EN provides detailed information for the ELSP current-limiting back-up fuse.

Catalog Section	Description	kV Class	Base Part Number	Notes	
SIDE- AND COVER-MOUNTED BAY-O-NET FUSE ASSEMBLY					
	Flapper Side Wall-Mount	23 kV	4000361C99FV		
	Side Wall		4000361C99MC		
	w/o Flapper Valve				
	Cover-Mount (Short)		4001177B51MC		
	Cover-Mount (Long)		4001177B53MC		
CA132015EN	Silver-plated	38 kV	4038380B03M		
CURRENT SENSING BAY-O-NET FUSE LINK					
	6 A		4000353C04	1, 3, 4	
	10 A		4000353C06	1, 3, 4	
	15 A		4000353C08	1, 3, 4	
	25 A		4000353C10	1, 3, 4	
	40 A		4000353C12	1, 3, 4	
	65 A		4000353C14	1, 3, 4	
	100 A		4000353C16	1, 3, 4	
CA132009EN	140 A		4000353C17	1, 3, 4	
DUAL SENSING BAY-O-NET FUSE LINK					
	3 A		4000358C03	1, 3, 4	
	8 A		4000358C05	1, 3, 4	
	15 A		4000358C08	1, 3, 4	
	25 A		4000358C10	1, 3, 4	
	50 A		4000358C12	1, 3, 4	
	65 A		4000358C14	1, 3, 4	
	100 A		4000358C16CB	1, 3, 4	
CA132010EN	140 A		4000358C18CB	1, 3, 4	
DUAL ELEMENT BAY-O-NET FUSE LINK					
	5 A		4038108C03	1, 3, 4	
	6 A		4038108C04	1, 3, 4	
	8 A		4038108C05	1, 3, 4	
	12 A		4038108C06	1, 3, 4	
	15 A		4038108C07	1, 3, 4	
	25 A		4038108C09	1, 3, 4	
	40 A		4038108C11	1, 3, 4	
	50 A		4038108C12	1, 3, 4	
	CA132011EN	65 A		4038108C14	1, 3, 4
	HIGH AMPERE OVERLOAD BAY-O-NET FUSE LINK				
	65 A		4038361C03CB	2, 3, 4	
	100 A		4038361C04CB	2, 3, 4	
	125 A		4038361C05CB	2, 3, 4	
CA132007EN	Shorting Bar (Solid Link)		4038361C10CB	2, 3, 4	
BAY-O-NET FUSE LINK					
	10 A	38 KV	4000380C06CB		
	15 A		4000380C08CB		
	25 A		4000380C10CB		
	30 A		4000380C11CB		
	40 A		4000380C12CB		
CA132006EN	65 A		4000380C14CB		
ISOLATION LINK 23 KV (MAXIMUM)					
CA132012EN			3001861A_ _ _	3	
ELSG FULL RANGE					
	240-82	Current-Limiting Fuse	359_ _ _ _ M_ M		
			(See Table 2 Below)		
ELSP BACKUP					
	CA132013EN	Current-Limiting Fuse	CBUC_ _ _ _ _		
			(See Table 1 Page 46)		

1. Add suffix "B" to order **individual fuse**; add "M" to order **bag of 50**.
2. When ordering high ampere overload Bay-O-Net Fuse Link, a silver-plated Bay-O-Net Fuse Assembly, part number 4038804B03M, must be ordered.
3. To coordinate an isolation link with a Bay-O-Net Fuse when an ELSP Fuse is not used, see Catalog Section 240-47.
4. For recommended ELSP backup CLF ratings, see Catalog Section 240-98 or TransFusion Coordination Program.

MagneX single-phase interrupter

Eaton offers a solution to the utility sector wanting to eliminate oil exposure in the field when operation occurs due to transformer overloads with its Cooper Power series MagneX™ single-phase interrupter. There is no need for replacement fuse links, resulting in economic value to the user. In addition, a MagneX interrupter in series with a back-up, current-limiting fuse offers additional protection.

TABLE 1
Voltage Ratings and Characteristics

Description	Rating
Impulse 1.2x50 Microsecond Wave	150 kV
60 Hz-1 Minute Voltage Withstand	50 kV
Continuous Current Rating	42 A
Switching Load Currents, 200 Times	42 A
Magnetizing Current Switching	200 Times

Continuous current ratings and dielectric testing are in accordance with ANSI/IEEE Std C57.12™ standard. Switching and Fault Close IEEE Std C37.41™ standard. Overload Protection IEEE Std C57.41™ standard.

TABLE 2
Interrupting Rating

Voltage kV-LG	RMS Symmetric (A)	RMS Asymmetric (A)
8.3	2800	4200
15.5	1500	2250
23.0	500	750



TABLE 3
MagneX Significant Digit Catalog Number System

Example: To order a single-phase MagneX interrupter without indicator, single-phase trip, with float and E12 sensor, the catalog number would be **MX1BN1SYE12**. (Refer to Catalog Section 240-34.)

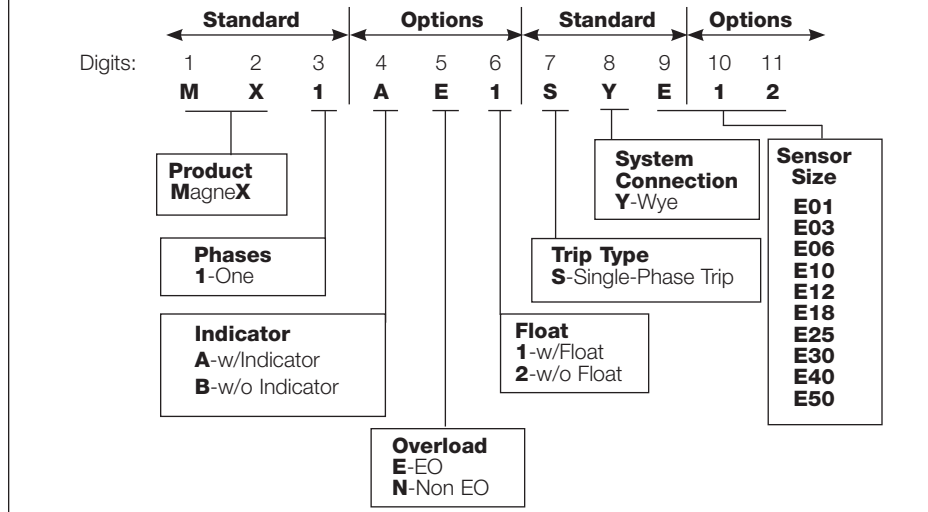

To select the correct isolation link, use Table 1 to cross reference the isolation link to the selected MagneX sensor. **An isolation link is required if the MagneX is not in series with a current-limiting fuse.**

TABLE 4
Isolation Link - MagneX Correlation Chart

Sensor Number	Isolation Link
E01	3637803B01
E03	3637803B08
E06	3637803B02
E10	3637803B09
E12	3637803B10
E18	3637803B03
E25	3637803B03
E30	3637803B05
E40	3637803B05
E50	3637803B05

Ordering information

Use Table 6 to determine the correct MagneX interrupter suffix (sensor number) for the application.

Use Table 3 to determine the catalog number.

When ordering a MagneX interrupter with a standard handle, a hardware kit must be ordered separately. Use Table 7 to determine the hardware kit catalog number.

To select the correct isolation link, use Table 4 to cross reference the isolation link to the selected MagneX interrupter.

An isolation link is required if the MagneX is not in series with a current-limiting fuse.

Example – MagneX interrupter with an emergency overload, indicator, and a float in series with an ELSP Current-Limiting Fuse for a single-phase, 7.2 kV phase-to-ground, 25 kVA transformer, specify:

- 1 – 40 A ELSP Fuse 3543040M61M
- 1 – MagneX interrupter MX1AE1SYE06
- 1 – Hardware Kit (with Emergency Overload, indicator, and no adaptor) 3638535A05

See the following Catalog Sections for further information:

ELSP Fuse Holder TD132003EN

ELSP Current-Limiting Backup Fuse CA132013EN

MagneX with current-limiting fuse

To order a MagneX interrupter and current-limiting fuse combination, see Table 5.

TABLE 5
Hardware Kits

Description	Catalog Number
Without emergency overload	3638535A04
With emergency overload	3638535A05
With adaptor without emergency overload	3638535A07
With adaptor with emergency overload	3638535A08
Hotstick adaptor only	3639585A01

Using TCC Curves

To determine or confirm the MagneX interrupter will coordinate with upstream and down stream system requirements, use the time-current characteristic curves (See R240-91-310). For full size TCC curves, contact your Eaton representative.

TABLE 6
Single-Phase Transformer (Phase-to-Ground) Applications Correlation Chart

kVA/kV	Primary Voltage kV														
	2.4	4.16	4.8	6.9	7.2	7.62	7.97	8.32	12.00	12.47	13.2	13.8	14.4	16.34	19.92
10	E06	E06	E03	E03	E03	E03	E03	E03	E01	E01	E01	E01	E01	E01	E01
15	E10	E06	E06	E03	E03	E03	E03	E03	E03	E03	E03	E03	E03	E01	E01
25	E18	E10	E10	E06	E06	E06	E06	E06	E03	E03	E03	E03	E03	E03	E03
37.5	E25	E18	E12	E10	E10	E10	E10	E10	E06	E06	E06	E06	E06	E03	E03
50	E30	E18	E18	E12	E12	E12	E12	E10	E06	E06	E06	E06	E06	E06	E06
75	E50	E30	E25	E18	E18	E18	E18	E18	E10	E10	E10	E10	E10	E06	E06
100	E50	E40	E30	E25	E18	E18	E18	E18	E12	E12	E12	E12	E12	E10	E10
167	-	E50	E50	E40	E40	E40	E40	E30	E18	E18	E18	E18	E18	E18	E12
250	-	-	-	E50	E50	E50	E50	E50	E30	E30	E30	E30	E30	E25	E18
333	-	-	-	-	-	-	-	E50	E40	E40	E40	E40	E40	E30	E25
500	-	-	-	-	-	-	-	-	E50	E50	E50	E50	E50	E50	E40

Notes:

Recommendations are based on:

- Minimum trip curves, and Maximum trip and clear curves, R240-91-310.
- Deration factor of 0.5% per °C above 25 °C.
- Allowable loading greater than 140% for four (4) hours in accordance with ANSI/IEEE Std C57.91.1981™ standard Guide for Loading Distribution Transformers, Table 6.

TABLE 7
Recommended MagneX Interrupter Sensor and ELSP Current-Limiting Fuse Combinations

Nominal Single Phase (kV Phase-to-ground)	8.3 kV			15.5 kV		23 kV
	2.4	4.16-4.8	6.9-8.0	12.0-14.4	16.34	19.92
10 kVA ELSP Rating with Emergency Overload MagneX Element	30 E06	30 E03	30 E03	30 E01	30 E01	30 E01
15 kVA ELSP Rating with Emergency Overload MagneX Element	50 E10	30 E06	30 E03	30 E03	30 E01	30 E01
25 kVA ELSP Rating with Emergency Overload MagneX Element	80 E18	50 E10	30 E06	30 E03	30 E03	30 E03
37.5 kVA ELSP Rating with Emergency Overload MagneX Element	100 E18	80 E12	50 E10	30 E06	30 E03	30 E03
50 kVA ELSP Rating with Emergency Overload MagneX Element	150 E30	100 E18	50 E12	30 E06	30 E06	30 E03
75 kVA ELSP Rating with Emergency Overload MagneX Element	150 E40	125 E25	100 E18	40 E10	30 E06	30 E06
100 kVA ELSP Rating with Emergency Overload MagneX Element	250 E50	165 E40	100 E18	50 E12	40 E10	30 E06
167 kVA ELSP Rating with Emergency Overload MagneX Element	- -	180 E50	150 E40	80 E18	80 E18	50 E12

Notes:

Table shows minimum recommended ELSP Fuse ratings. Recommended ELSP Backup Fuse (described in Catalog Section CA132013EN) will coordinate with the MagneX interrupter and melt on internal transformer faults. The MagneX interrupter recommendations are based on:

- Minimum trip curves, and Maximum trip and clear curves R240-91-310.
- Deration factor of 0.5% per °C above 25°C.
- Allowable loading greater than 140% for four hours in accordance with IEEE Std C57.41™-1981 standard guide for Loading Distribution Transformers, Table 6.

MagneX three-phase interrupter

The Three-Phase MagneX interrupter offers a solution to the utility wanting to eliminate oil exposure in the field when operation occurs due to transformer overloads. There is no need for replacement fuse links, resulting in economic value to the user. In addition, a MagneX interrupter in series with a back-up, current-limiting fuse offers additional protection.

MagneX interrupter specification information

- Breaker shall be installed on the primary side of transformer.
- Breaker shall have the capability to energize and de-energize the 3Ø transformer by one hotstick operation.

TABLE 1
Voltage Ratings and Characteristics

Description	kV	Rating
Impulse 1.2x50 Microsecond Wave	150 kV	-
60 Hz-1 Minute Voltage Withstand	50 kV	-
Continuous Current Rating	-	42
Switching Load Currents	-	42

Continuous current ratings and dielectric testing are in accordance with IEEE Std C57.12™ standard.
Switching and Fault Close IEEE Std C37.41™ standard.
Overload Protection IEEE Std C57.41™ standard.

TABLE 2
Interrupting Rating

Voltage kV-LG (A)	RMS Symmetric (A)	RMS Asymmetric (A)
8.3	2800	4200
15.5	1500	2250
23.0	500	750

TABLE 3
Hardware Kits

Description	Catalog Number
Standard Handle Kit & Hardware without Emergency Overload	3638535A09
Hotstick Adapter	3639585A01

TransFusion™ coordination program

This free, web-based, easy-to-use coordination tool makes transformer protective device selection for pad-mounted transformers effortless. By simply inputting a few pieces of data and selecting the desired level of protection, you can quickly find the right Eaton product within its Cooper Power series fuse product line, whether its the ELSP fuse, Bay-O-Net fuse, or MagneX interrupter suitable for your application. The TransFusion coordination program provides you the flexibility of trying various combinations before deciding on the one that best fits your application needs. A simple click of the print button allows you to print your TCC curves and part numbers.

Go to this site for your coordination program
www.coopertransfusion.com.

TABLE 4
MagneX Significant Digit Catalog Number System

Example: To order a two- or three- phase MagneX interrupter without indicator, single- and three-phase trip, with float and E12 sensor, the catalog number would be **MX3BN1SYE12**. (Refer to Catalog Section 240-33.)

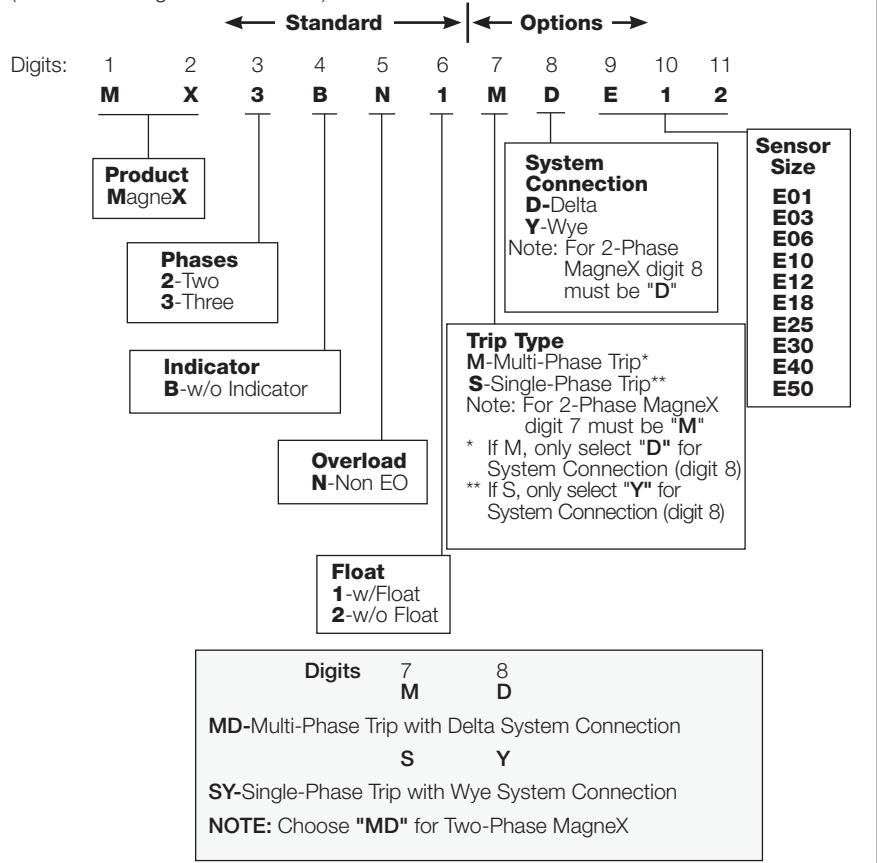

ORDERING INFORMATION

Use Table 4 to determine the catalog number.

When ordering a MagneX interrupter with a standard handle, a hardware kit must be ordered separately. Use Table 3 to determine the hardware kit catalog number.

Two- and three-phase MagneX interrupter operation

Figure 1 demonstrates the circuit diagram for the three-phase MagneX interrupter with single-phase sense, single-phase trip. The three-phase MagneX interrupter with single-phase sense, single-phase trip contains one sensors per phase. It reacts to fault currents on one phase and will cause tripping of that phase only. The MagneX interrupter then can be reset via the single operating handle by opening all three phases and closing all phases back in simultaneously.

Figure 2 demonstrates the circuit diagram for the three-phase MagneX interrupter with single-phase sense, three-phase trip, containing one sensor in two of the three phases. This product should only be applied to delta-connected primary transformers, where any fault current flow in one phase will also flow in an adjacent phase. It reacts to fault currents on one phase and will cause tripping of all three phases. The MagneX interrupter then can be reset via the single operating handle by opening all three phases and closing all phases back in simultaneously.

The three-phase MagneX interrupter with single-phase sense, three-phase trip should always be used in series with at least one backup current-limiting fuse in each of the three phases.

The backup current limiting fuses (see ELSP catalog section 240-98) provide high-current interruption capability.

Figure 3 shows the circuit diagram for the two-phase MagneX interrupter. The two-phase MagneX interrupter was specifically designed for single-phase, two bushing transformers, where disconnection of both bushings is desired following fault/overload detection. The MagneX interrupter will react to a fault sensed in either leg of the transformer primary. Interruption takes place in both interruption chambers simultaneously, disconnecting both legs of the transformer from the circuit.

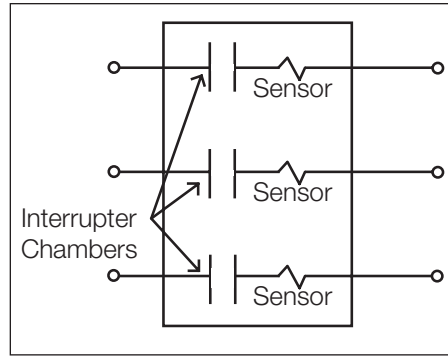

Figure 1.
Three-phase MagneX interrupter, single-phase sense, single-phase trip.

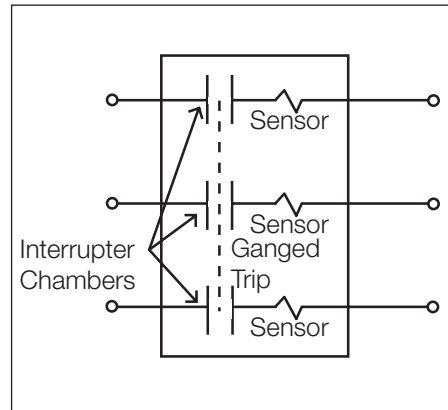

Figure 2.
Three-phase MagneX interrupter, single-phase sense three-phase trip.

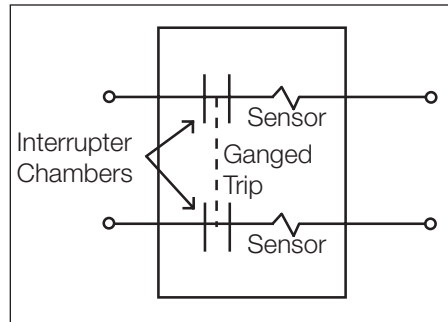

Figure 3.
Two-phase MagneX interrupter.

Faulted circuit indicators

Eaton offers a wide variety of faulted circuit indicators (FCIs) ranging from basic circuitry models in its Cooper Power series delayed reset style to the more sophisticated circuitry of the test point reset and electrostatic reset types. Eaton's Cooper Power series S.T.A.R.™ faulted circuit indicator product line offers six basic types of FCIs and each unit is tailored to be the most reliable for the intended application. Each type varies by reset method and the type of system it connects to.

Standard S.T.A.R. features include:

- **LO/Hi trip rating selection** – Innovative trip ratings greatly simplify FCI selection application
- **Current transformer sensing design** – For maximum trip accuracy and elimination of false tripping on adjacent cable events
- **Inrush restraint** – Eliminates false tripping by ignoring inrush currents caused by reclosing operations of protective devices on the system. A dead time of 200 ms will activate the inrush restraint feature.
- **Low-pass filter technology** – Prevents false tripping due to capacitive cable discharge
- **Design tested to IEEE Std 495™ standard and manufactured in ISO 9001 facility** – To ensure highest performance and quality

In addition to the above features, Eaton's Cooper Power series PATHFINDER™ FCIs include:

- **Variable trip technology** – Single trip rating for one-size-fits-all application
- **Auto adjusting trip technology** – Detects average load current over time above or below 75 A and adjusts trip rating to 200 A or 800 A automatically.
- **Self adjusting reset restraint** (test point mounted model) – “Learns” your system voltage and won't allow false resetting due to backfeed voltage
- **BLOC™** – Battery life optimization circuitry for maximizing battery life
- **Remote fiber optic cable** (test point mounted model) – Optional remote for convenient remote indication





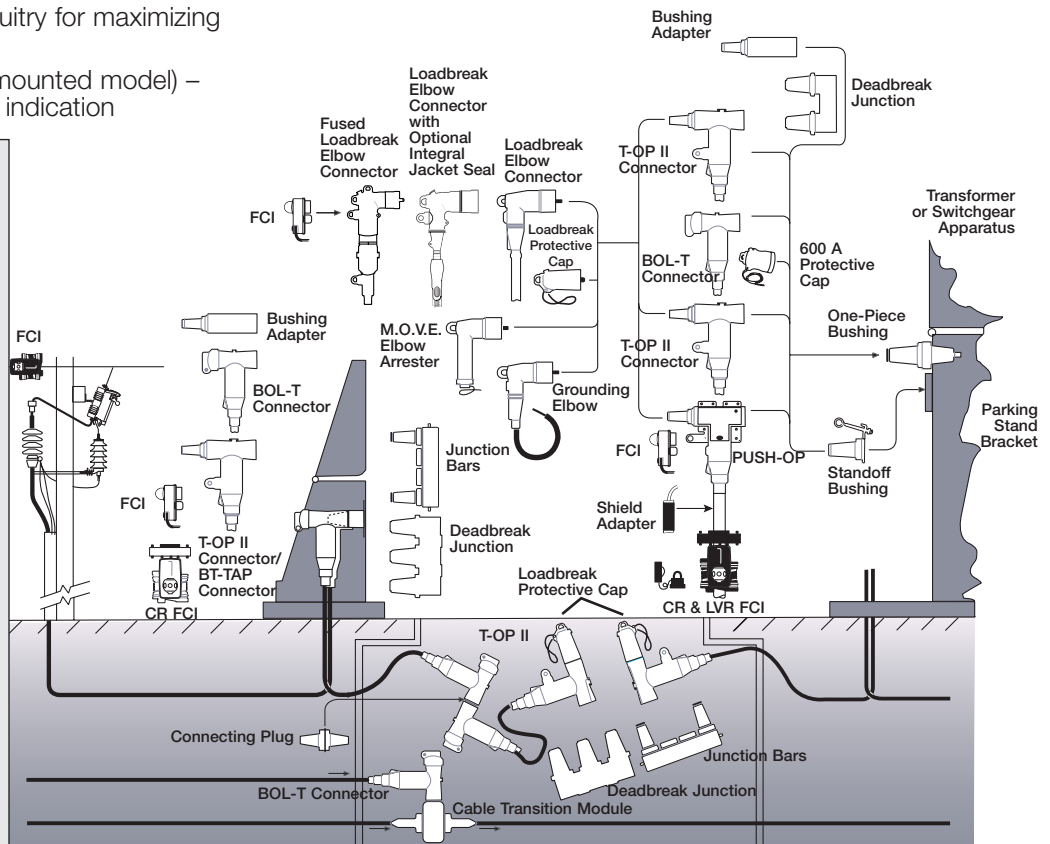

PATHFINDER test point faulted circuit indicator specification information

- Fault indication on minimum 200 A di/dt within 100 ms (variable trip).
- Response time of 3 rms or less, for coordination with current-limiting fuses (fixed trip).
- Inrush restraint to prevent false tripping due to current inrush conditions.
- Low pass filter specifically tuned to prevent false tripping on high frequency transients, but to allow proper indication on systems using current-limiting fuses.
- Temperature compensation for accurate and reliable performance over a temperature range of -40 °C to +85 °C.
- Reset restraint to prevent false reset due to excessive voltage feedback levels up to 80% of nominal system voltage (STVT).
- Installation using single hotstick.

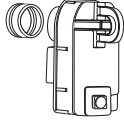
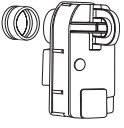

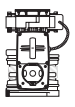
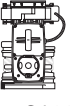
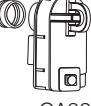
For 15 kV, 25 kV and 35 kV Class

Catalog Section	Description	Base Part Number	Notes
	TEST POINT RESET		
	Adapter Kit	STAK	4
	High (HI)-Trip	STHI	1
	High (HI)-Trip w/Aux. Contact	STHIA	1
	High (HI)-Trip w/Adapter Kit	STHIK	
	Low (LO)-Trip	STLO	1
	Low (LO)-Trip w/Aux. Contact	STLOA	1
CA320002EN	Low (LO)-Trip w/Adapter Kit	STLOK	
	PATHFINDER TEST POINT RESET		
	Variable Trip	STVT	
	Variable Trip w/Aux. Contact	STVTA	
	Fiber Optic Remote Cable (6 ft.)	SFOC	2
	Reset Tool	SMRT	4
	Adapter Kit	STAK	4
	CA320003EN		
	LOW VOLTAGE RESET		
	High (HI)-Trip	SLHI	3
	High (HI)-Trip w/Aux. Contact	SLHIA	3
	Low (LO)-Trip	SLLO	3
	Low (LO)-Trip w/Aux. Contact	SLLOA	3
CA320004EN			
	ELECTROSTATIC RESET		
	High (HI)-Trip	SEHI	
	High (HI) Trip with LED (Light Emitting Diode) Indication	SEHIL	
	Low (LO)-Trip	SELO	
	Low (LO) Trip with LED (Light Emitting Diode) Indication	SELOL	
CA320005EN			
	CURRENT RESET		
	High (HI)-Trip	SCHI	1
	Low (LO)-Trip	SCLO	1
	High (HI) Trip with Auxiliary Contacts	SCHIA	1
	Low (LO) Trip with Auxiliary Contacts	SCLOA	1
CA320008EN			
	PATHFINDER CURRENT RESET		
	Variable Trip	SCVT	1
CA320009EN			
	TEST POINT HOT LINE INDICATOR		
	Hot Line Indicator	STHL	
	Adapter Kit	STAK	4
CA320010EN			
	PROGRAMMABLE DELAYED RESET		
	Auto Adjusting Trip, Programmable Reset 2, 4, 8, 24-Hour Reset	SDOH	
	Reset Tool	SMRT	4
CA320011EN			

Notes:

- To add remote **FISHEYE™** display add an "R" as the last character in the part number, or a "S" for the small remote display.
- SFOC (Star Fiber Optic Cable) standard length is 6 ft. add "09F" for 9 ft. fiber optic display, "12" for 12 ft., "25" for 25 ft.
- To add **universal power supply** (120, 208 or 277 VAC power connection), add a "U" as the last character in the part number.
- Accessories to be ordered separately.

Faulted circuit indicators

Type Description	Typical System Application	Physical Mounting Location	Voltage/Current Requirements
Test Point Reset	Underground	On the test point of the connector	Min. 5 kV L-G (2.4 kV for Pathfinder)
Low-Voltage Reset	Underground	On the URD shielded cable below the connector	A secondary voltage source (min. 105 volts)
Electrostatic Reset	Overhead	On bare or insulated non-shielded cable	Min. 6.9 kV L-G
Programmable Delayed Reset	Overhead	On overhead bare or insulated non-shielded cable	None (Lithium battery powered with programmable reset)
Current Reset	Underground and Overhead	On the URD shielded cable below the connector and on overhead bare or insulated non-shielded cable	Min. 2.4 A continuous

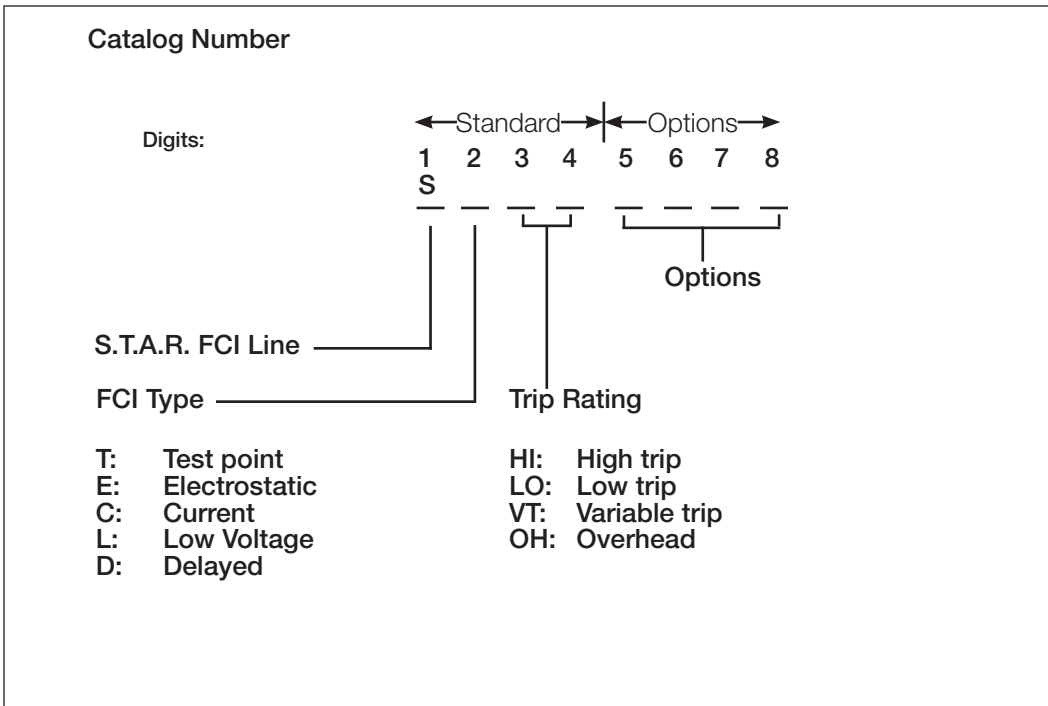

S.T.A.R. faulted circuit indicators features

	Model/Type	Test Point Reset	PATHFINDER Test Point	Low Voltage Reset	Electrostatic Reset	Programmable Delayed Reset	Current Reset	PATHFINDER Current Reset
	Base Part Numbers	STLO STHI	STVT	SLLO SLHI	SELO SEHI	SDOH	SCLO SCHI	SCVT
	Catalog Section	CA320002EN	CA320003EN	CA320004EN	CA320005EN	CA320011EN	CA320008EN	CA320009EN
Application	Overhead				•	•	•	•
	Underground/Pad-mounted	•	•	•			•	•
Trip Rating	High/Low Trip Rating	•		•	•		•	
	Variable Trip Rating (PATHFINDER™)		•					•
	Auto Adjusting Trip					•		
Standard Features	Inrush Restraint	•	•	•	•	•	•	•
	Temperature Compensation	•	•	•	•			
	Low Pass Filter	•	•	•	•	•	•	•
	Battery Life Optimization Circuitry		•			•		
	Reset Restraint		•	•				
	Single Hot-Stick Installation	•	•	•	•	•	•	•
	Automatic Reset	•	•	•	•	•	•	•
	Open-Core CT Design	•	•	•	•	•		
	Closed-Core CT Design						•	•
Display Type	LED Display		•		Optional	•		
	FISHEYE Display			•	•		•	•
	Flag Display	•						
Available Options	Auxiliary Contacts for SCADA	•	•	•				•
	Remote FISHEYE Display	•		Standard			•	•
	Small Remote Display	•					•	•
	Remote Fiber Optic Display		•					
	Manual Testing/Reset Tool		•			•		
	Test Point Adapter Kit	•	•					
	Universal Power Supply			•				
Power Requirements	Battery Powered		•			•		
	Line Powered	•			•		•	•
	Secondary Source			•				
	Externally Replaceable Battery							
Reset Requirements	2.4 kV L-G		•					
	5 kV L-G	•						
	7.2 kV L-G				•			
	90 VAC			•				
	2.4 Amps Continuous						•	
	2.0 Amps Continuous							•
	Other					Programmable		

Sectionalizing cabinets

Eaton's Cooper Power™ series versatile single- and three-phase SecTER™ sectionalizing terminals are designed as cable sectionalizing centers, or as permanent or temporary transformer pad covers.

The aesthetic low profile design provides unobtrusive installations for sectionalizing, tapping or terminating underground cable.

The top hinged diagonally cut removable cover and cabinet are designed for easy one man opening. Recessed door and low sill provides improved access to interior terminations. A door stop prevents the door from accidentally closing.

TGIC powder coating exceeds ANSI® coating requirements.

Standard Munsell Green 7GY3.29/1.5 twelve gauge mild steel designs with standard stainless steel hardware are available. For highly corrosive environments, stainless steel or aluminum are also available. Continuous seam welding ensures a sturdy smooth cabinet.

Multiple configurations are available. A parking lot design is available on most SecTER cabinets that provides multiple locations for parking standoffs, portable feedthrus, and other cable accessories. A welded-on ground nut is also provided for each phase.

Universal mounting plates are painted light grey for optimum visibility and accept 200 amp or 600/900 amp, two-, three-, or four-position junctions with u-straps and Eaton's Cooper Power series Cleer™ 600 A loadbreak connectors. Standard SecTER designs are available in a variety of sizes to suit typical applications and can also be ordered with junctions factory installed.



Optional features

- 200 A loadbreak junctions installed
- 600 A deadbreak junctions installed
- Cleer 600 A loadbreak connectors installed
- Available in grey, tan, or brown colors
- Angled mounting plates
- 3/8" copper ground rod installed
- Mild steel base extensions
- Fiberglass ground sleeves

Ordering information

1. Select size of SecTER cabinet from Table 1 based on junctions required. Refer to figures referenced (shown on pages 4 through 7) to confirm SecTER cabinet configuration meets requirements.
2. Build SecTER catalog number from Table 2 based on size selected from Table 1 and options required.
3. Fiberglass ground sleeves are ordered separately. If ground sleeve is required, select catalog number from Table 3 on page 61.
4. Mild steel base extensions are ordered separately. If base extension is required, select catalog number from Table 4 on page 61.

Note: Width and depth dimensions of ground sleeves or base extensions must be matched to SecTER cabinet selected.

"S" = Standard. Recommended for best balance of size (footprint) and operability (frontplate space and standoff pockets) for typical applications.
 "O" = Optional. Also available if the application requires compromise in size and/or operability.

TABLE 1

SecTER Cabinet Matrix											Standoff Pocket Placement		Figure
Single-Phase										Below	In-Line with		
Dimensions	200 A, 15 kV			200 A, 25 & 28 kV			200 A, 35 kV			Mtg. Plates	Mtg. Plates		
	2-way	3-way	4-way	2-way	3-way	4-way	2-way	3-way	4-way				
30H X 24W X 22D	O	O	O	O	O	O				yes	no	1	
30H X 30W X 22D	S	S	S	S	S	S	S	S	S	yes	yes	2	
Single-Phase										Pocket Placement		Figure	
Dimensions	600 A, 15/25 kV			600 A, 35 kV			Cleer Loadbreak Connector			Below	In-Line with		
	2-way	3-way	4-way	2-way	3-way	4-way	15 kV	25 kV	28 kV	Mtg. Plates	Mtg. Plates		
30H X 24W X 22D	O	O	O							yes	no	1	
30H X 30W X 22D	S	S	S	S	S		S	S	S	yes	yes	2	
Three-Phase										Pocket Placement		Figure	
Dimensions	200 A, 15 kV			200 A, 25 & 28 kV			200 A, 35 kV			Below	In-Line with		
	2-way	3-way	4-way	2-way	3-way	4-way	2-way	3-way	4-way	Mtg. Plates	Mtg. Plates		
30H X 48W X 22D	S	O		O	O					yes	no	3	
30H X 66W X 22D (A)	O	S		S	S					yes	yes	4	
30H X 66W X 22D	O	O	O	O	O	O				yes	no	5	
30H X 84W X 22D	O	O	S	O	O	S	S	S	O	yes	yes	6	
30H X 98W X 30D	O	O	O	O	O	O	O	O	S	yes	yes	7	
Three-Phase										Pocket Placement		Figure	
Dimensions	600 A, 15/25 kV			600 A, 35 kV			Cleer Loadbreak Connector			Below	In-Line with		
	2-way	3-way	4-way	2-way	3-way	4-way	15 kV	25 kV	28 kV	Mtg. Plates	Mtg. Plates		
30H X 48W X 22D	O	O								yes	no	3	
30H X 66W X 22D (A)	S	O								yes	yes	4	
30H X 66W X 22D	O	O	O				S	S	S	yes	no	5	
30H X 84W X 22D	O	S	S	S	S		O	O	O	yes	yes	6	
30H X 98W X 30D	O	O	O	O	O	S	O	O	O	yes	yes	7	

TABLE 2

SecTER Catalog Number Selection

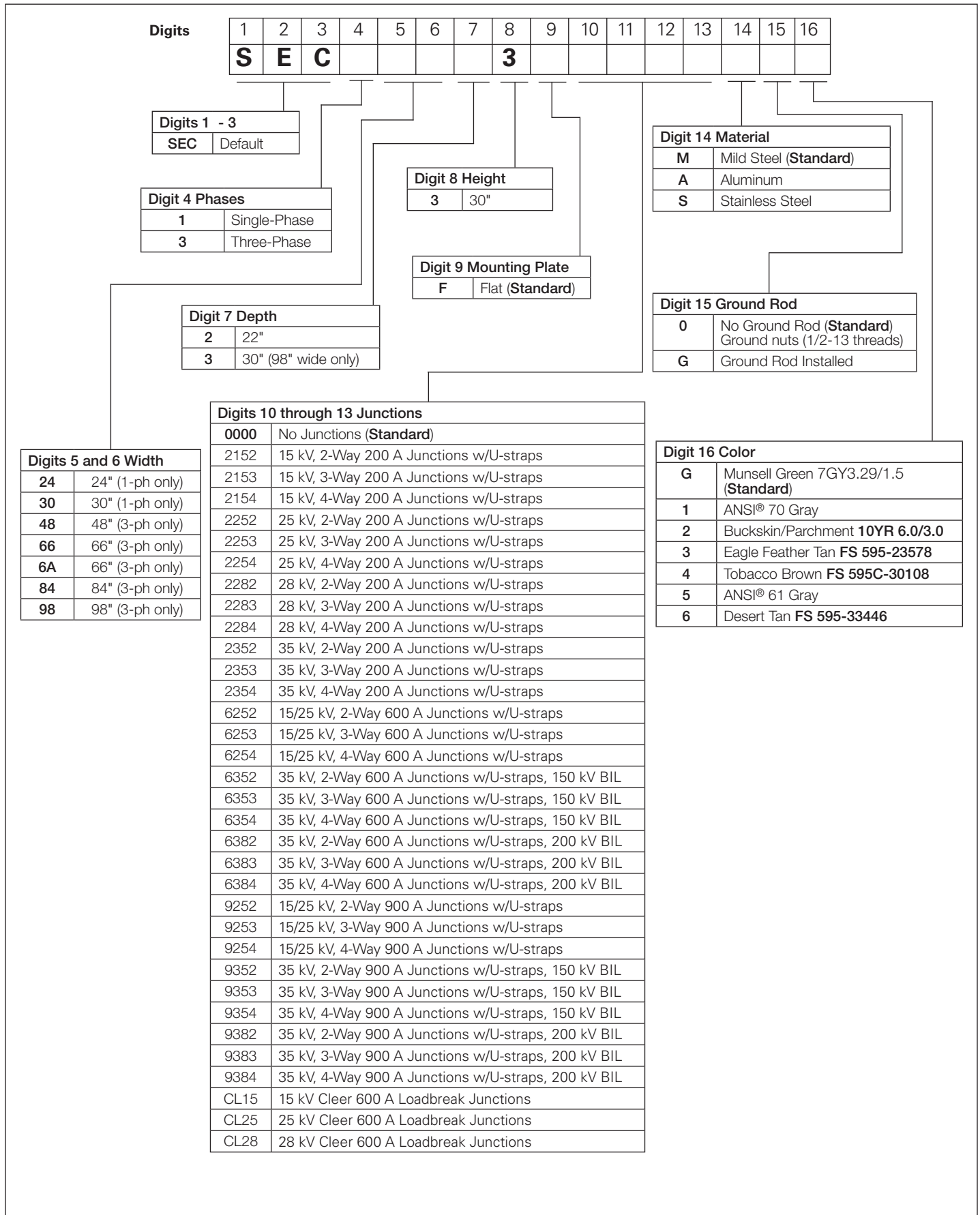

Sectionalizing cabinets

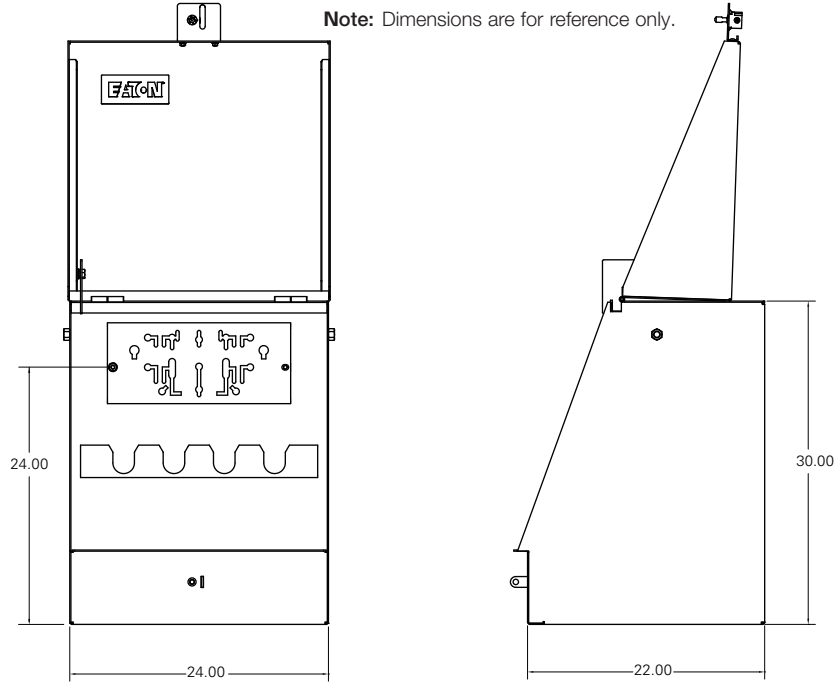

Figure 1. SEC12423F0000M0G SecTER cabinet shown.

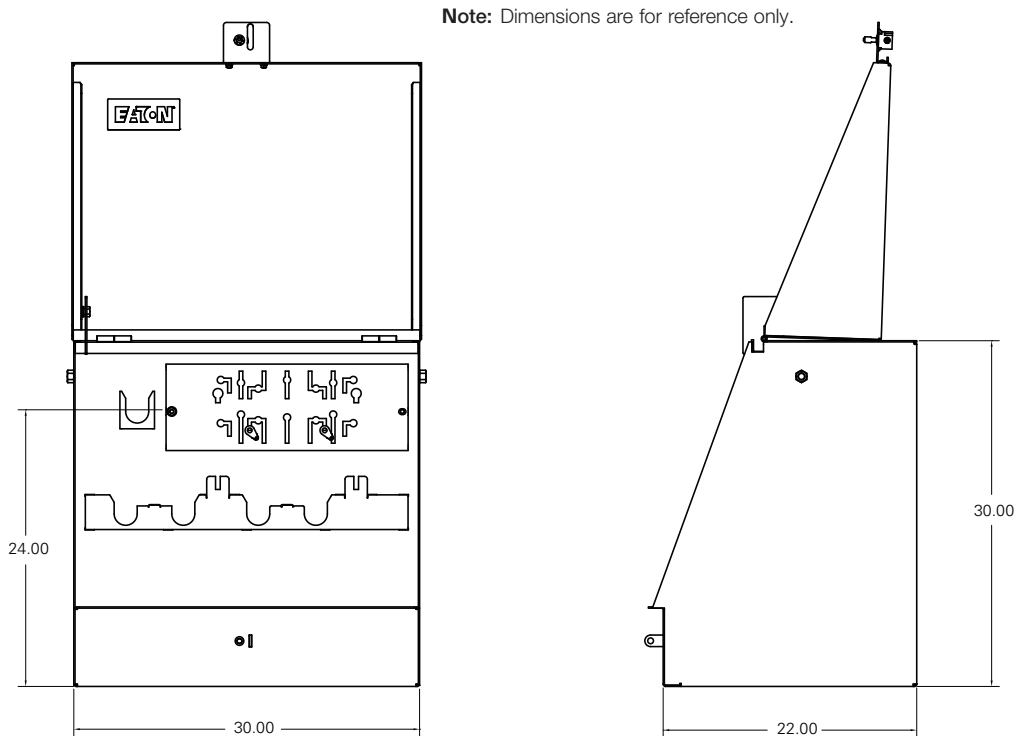

Figure 2. SEC13023F0000M0G SecTER cabinet shown.

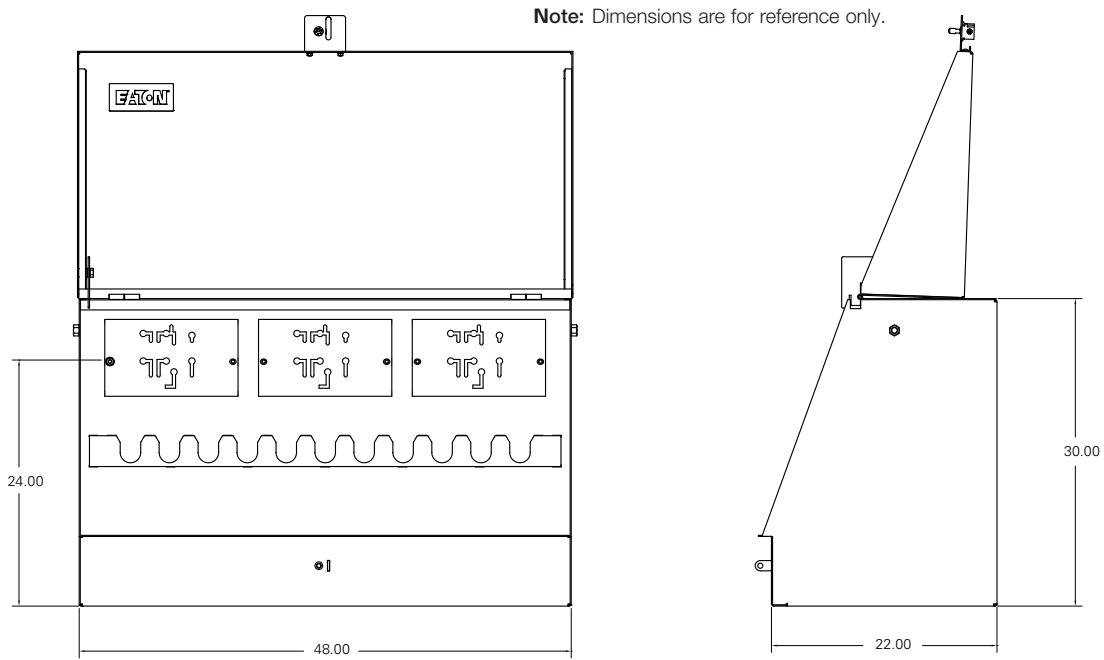

Figure 3. SEC34823F0000M0G SecTER cabinet shown.

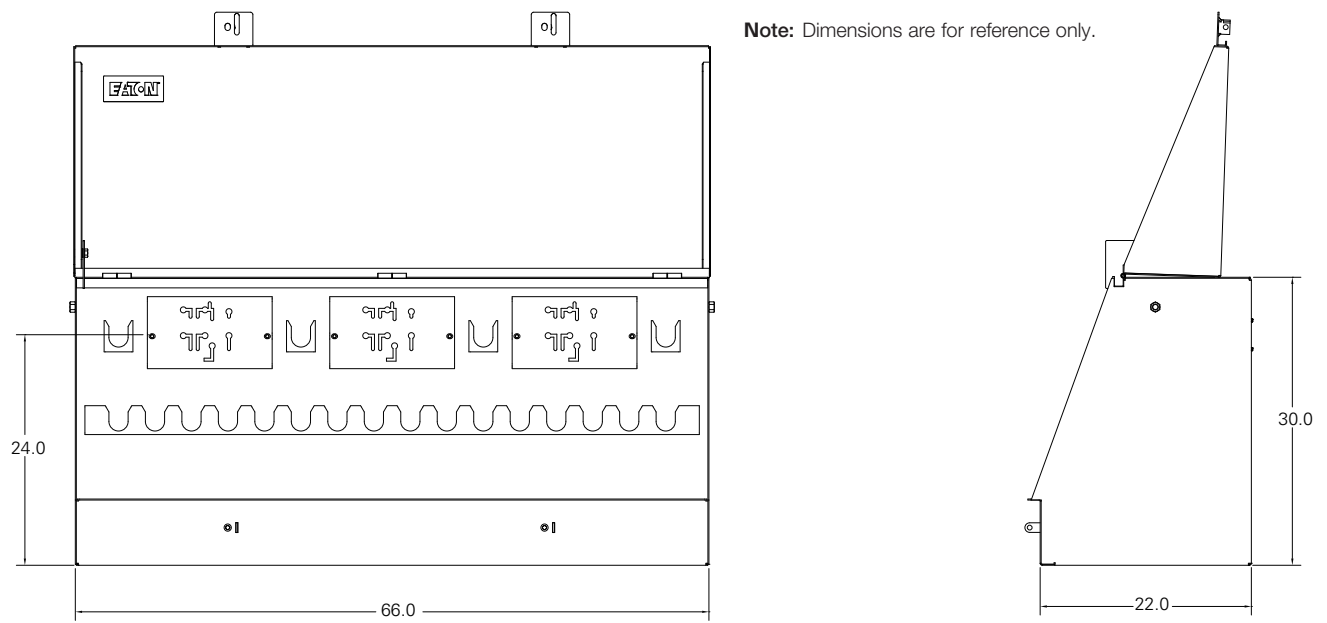

Figure 4. SEC36A23F0000M0G SecTER cabinet shown.

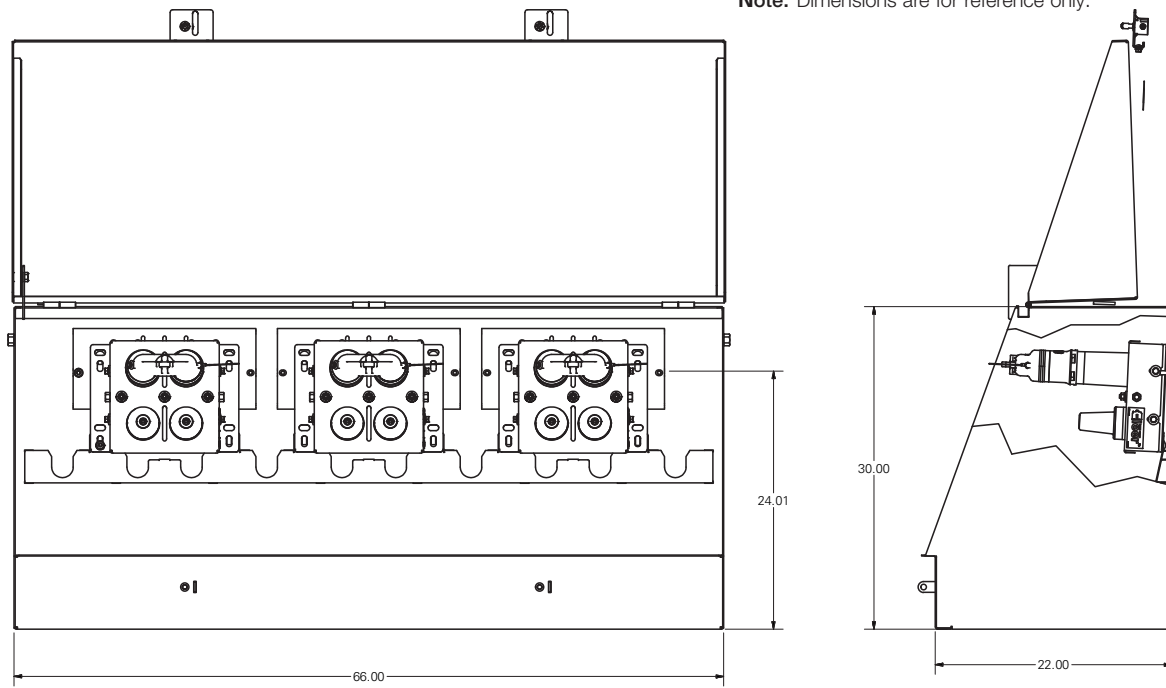

Figure 5. SEC36623F0000M0G SecTER cabinet shown with 600 A Clear loadbreak installed.

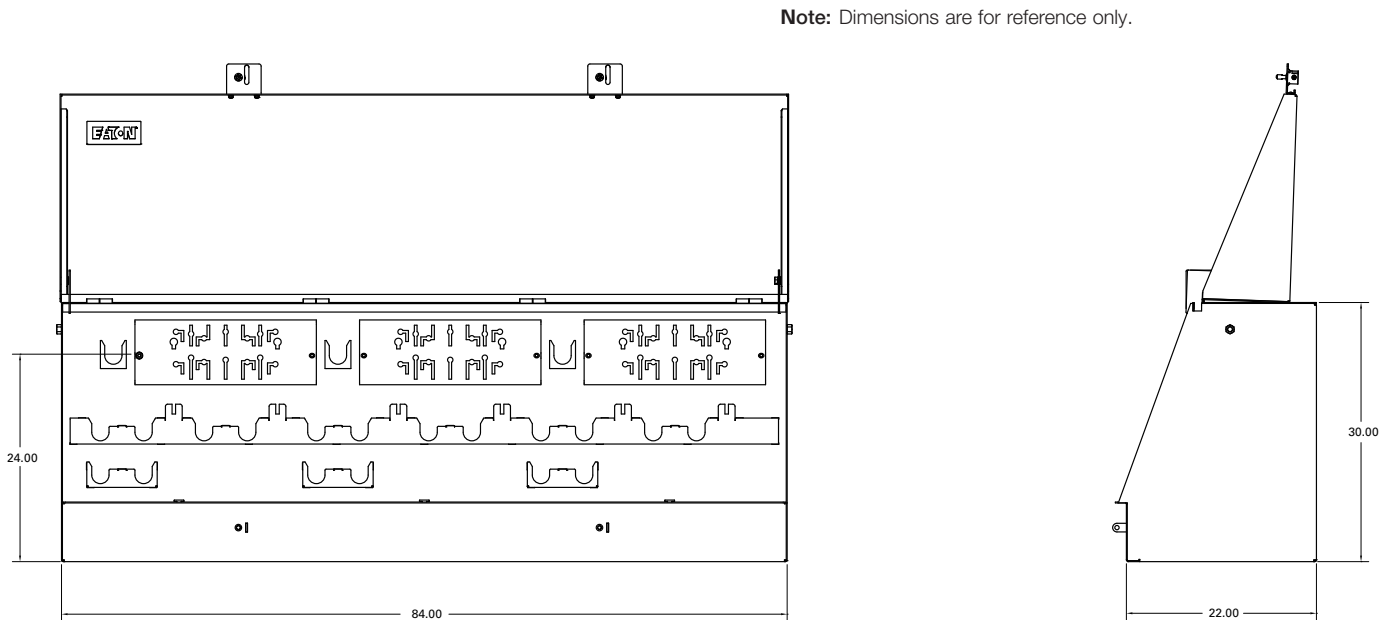

Figure 6. SEC38423F0000M0G SecTER cabinet shown.

Note: Dimensions are for reference only.

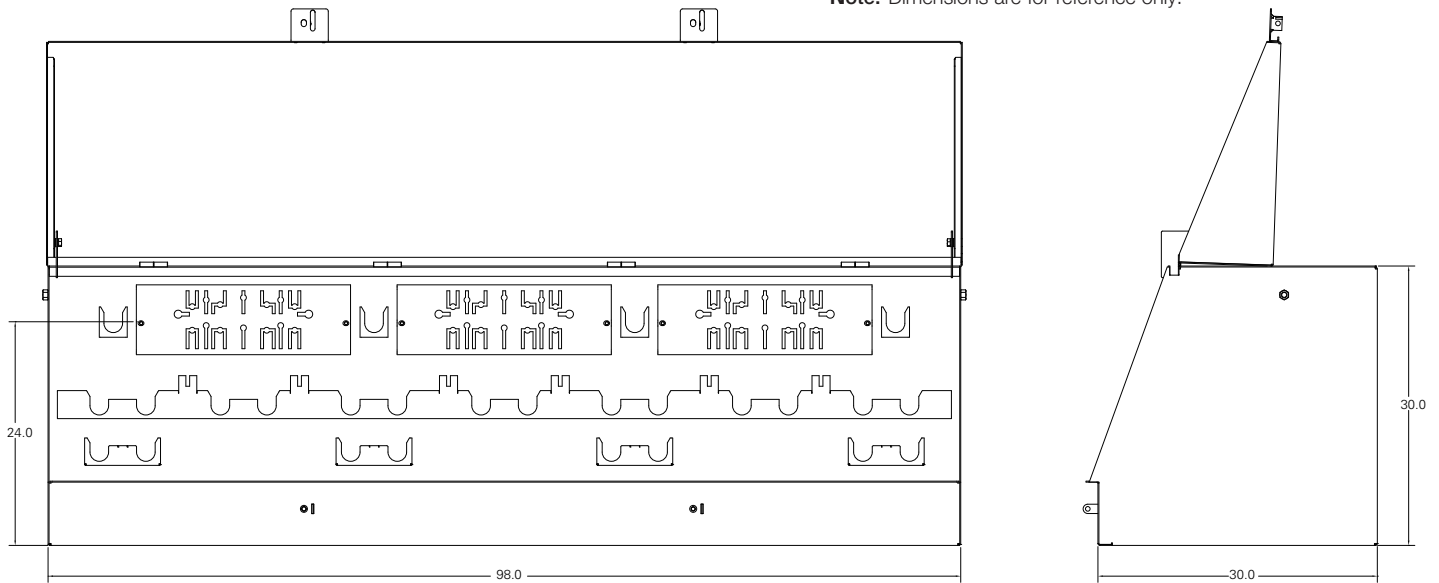

Figure 7. SEC39833F0000M0G SecTER cabinet shown.

Fiberglass ground sleeves

Lightweight, corrosive free ground sleeves provide ground level mounting base and underground cable compartment, allowing unrestricted movement of terminations.

TABLE 3
Fiberglass Ground Sleeve Dimensional Information in Inches

18" High			
Catalog Number	Height	Width	Depth
GS182422	18.0	24.0	22.0
GS183022	18.0	30.0	22.0
GS184822	18.0	48.0	22.0
GS186622	18.0	66.0	22.0
GS188422	18.0	84.0	22.0
GS189830	18.0	98.0	30.0
30" High			
Catalog Number	Description	Width	Depth
GS302422		24.0	22.0
GS303022		30.0	22.0
GS304822		48.0	22.0
GS306622		66.0	22.0
GS308422		84.0	22.0
GS309830		98.0	30.0

Steel base extensions

Mild steel base extensions provide pad mounted above ground cable compartment and can also be used with ground sleeves in applications where raising the SecTER cabinet to a greater height is required.

TABLE 4
Steel Base Extension Dimensional Information

18" High			
Catalog Number	Height	Width	Depth
SBE182422	18.0	24.0	22.0
SBE183022	18.0	30.0	22.0
SBE184822	18.0	48.0	22.0
SBE186622	18.0	66.0	22.0
SBE188422	18.0	84.0	22.0
SBE189830	18.0	98.0	30.0
24" High			
Catalog Number	Height	Width	Depth
SBE242422	24.0	24.0	22.0
SBE243022	24.0	30.0	22.0
SBE244822	24.0	48.0	22.0
SBE246622	24.0	66.0	22.0
SBE248422	24.0	84.0	22.0
SBE249830	24.0	98.0	30.0

Note: Width and depth dimensions of ground sleeves or base extensions must be matched to SecTER cabinet selected.

*To specify stainless steel base extension add "SS" to the end of the catalog number

Part number index

Base Part Number	Page	Base Part Number	Page	Base Part Number	Page	Base Part Number	Page	Base Part Number	Page
0113C	42	48410	40	2606754A03	45	3593040M02M	47	4001177B53MC	47
0190FC	42	48900	43	2606821A01	45	3593050M02M	47	BLRTP615	25, 26
0213CSS	42	48900-2	43	2606823A02	45	3593060M02M	47	BLRTP625	26
0213CX	42	49341	40	2606823A04	45	3593065M01M	47	BLRTP635	25, 26
0290FCS	42	49435	40	2610082P01	45	3593080M01M	47	BRK469	35
0290FHJ	42	49437	40	2625439A16B	12	3593100M01M	47	BT625	23, 24
0290MCX	42	100005	40	2625439A17B	12	3593125M01M	47	BT635	23, 24
359_ _ _ _M_ _M	47	100006-4	40	2637019B02	45	3594004M83M	47	BTP615	23, 24
0890CSJ	42	100006-7	40	2637019B04	45	3594008M83M	47	BTP625	23, 24
6990FHL	42	100006-12	40	2637023B01	45	3594012M83M	47	BTP635	23, 24
8613CK	42	100006-15	40	2637024C01M	45	3594015M83M	47	BW150F	45
8613FH	42	100006-16	40	2637160B01BS	12	3594020M83M	47	BW150R	45
8613FSK	42	100006-18	40	2637160B02BS	12	3594025M83M	47	CA225A	12
8613TN	42	100007-1	40	2637160B03BS	12	3594030M83M	47	CA225B	12
8690CK	42	100007-2	40	2637172B01BS	12	3594040M83M	47	CA625	24, 25, 26, 27
8690FH	42	100007-3	40	2637172B02BS	12	3594050M83M	47	CA635	24, 25, 26, 27
8690FSK	42	100007-4	40	2637172B03BS	12	3594060M83M	47	CBUC	47
8690TN	42	100007-6	40	2637407B03B	45	3594065M83M	47	CBUC08030C100	46
18415-3	43	100007-9	40	2637570A01B	12	3594080M83M	47	CBUC08040C100	46
18415-8	43	100007-23	40	2637585B01	45	3594100M83M	47	CBUC08050C100	46
19100	43	100057	40	2637604C01	45	3594120M83M	47	CBUC08065C100	46
26958	40	100075	40	2637700B01	45	3594150M83M	47	CBUC08080C100	46
26962-5	40	100096	40	2637700B02	45	3637803B01	48, 51	CBUC08100C100	46
26992CPS	40	100370CPS	40	2637904C01	45	3637803B02	48, 51	CBUC08125C100	46
26993	40	100399	40	2638370C01EX	14	3637803B03	48, 51	CBUC08150D100	46
26994	40	100400	40	2638372C01	45	3637803B05	48, 51	CBUC08165D100	46
30041	40	100433CPS	40	2638372C02R	45	3637803B08	48, 51	CBUC08180D100	46
30042	40	100434CPS	40	2638409C06B	14	3637803B09	48, 51	CBUC08250D100	46
30043	40	100440	40	2638640C01	45	3637803B10	48, 51	CBUC09030C100	46
30084	40	100455	40	2638772B03M	45	3638535A04	48	CBUC09040C100	46
30124	40	100456	40	2639081B01B	45	3638535A05	48	CBUC09050C100	46
30154	40	100459	40	2639205B01	14	3638535A07	48	CBUC09065C100	46
30450	40	100460	40	3001861A_ _ _	47	3638535A08	48	CBUC15030C100	46
30500	40	100470	40	3237686C03M	39	3638535A09	50	CBUC15040C100	46
30554CPS	40	100471	40	3237686C06M	39	3639585A01	48	CBUC15050C100	46
30584-3	43	100472	40	3237686C09M	39	4000353C04	47	CBUC15065C100	46
30584-25	43	100473	40	3237686C10M	39	4000353C06	47	CBUC15080C100	46
30584-30	43	100474	40	3237686C12M	39	4000353C08	47	CBUC15100C100	46
30611CPS	40	100600CPS	40	3237686C15M	39	4000353C10	47	CBUC15125C100	46
30642CPS	40	100601	40	3237686C18M	39	4000353C12	47	CBUC15150D100	46
30744	40	100602	40	3237758C09M	39	4000353C14	47	CBUC15165D100	46
30914	40	100603-7	40	3237758C10M	39	4000353C16	47	CBUC15180D100	46
36181CPS	40	100603-9	40	3237758C12M	39	4000353C17	47	CBUC17030C100	46
36457	40	100603-11	40	3237758C15M	39	4000358C03	47	CBUC17040C100	46
36459	40	100606	40	3237758C18M	39	4000358C05	47	CBUC17050C100	46
36467	40	100609	40	3237758C21M	39	4000358C08	47	CBUC17065C100	46
36472	40	100613	40	3238018C03M	39	4000358C10	47	CBUC23030C100	46
36474	40	100618	40	3238018C06M	39	4000358C12	47	CBUC23040C100	46
36476	40	100625CPS	40	3238018C09M	39	4000358C14	47	CBUC23050C100	46
36478	40	104742	43	3238018C10M	39	4000358C16CB	47	CBUC23065C100	46
36480	40	104742-2	43	3238018C12M	39	4000358C18CB	47	CBUC23080C100	46
36482CPS	40	118004	43	3238018C15M	39	4000361C99FV	47	CBUC23100C100	46
36484	40	133040	43	3238018C18M	39	4000361C99MC	47	CBUC23125D100	46
36486	40	133040-1	43	3238019C09M	39	4000380C06CB	47	CBUC23150D100	46
36488	40	133040-2	43	3238019C10M	39	4000380C08CB	47	CBUC23165D100	46
36490CPS	40	133045CPS	43	3238019C12M	39	4000380C10CB	47	CBUC35150D100	46
36494CPS	40	133045Z20	43	3238019C15M	39	4000380C11CB	47	CBUC38050D100	46
36496	40	0537980C06	45	3238019C18M	39	4000380C12CB	47	CBUC38065D100	46
36498	40	0537980C07	45	3238019C21M	39	4000380C14CB	47	CBUC38080D100	46
36559	40	0537980C12	45	3238020C18M	39	4038108C03	47	CBUC38100D100	46
36828CPS	40	0537980C22	45	3238020C21M	39	4038108C04	47	CBUC38120D100	46
36830CPS	40	0739658A02	45	3238020C24M	39	4038108C05	47	CBUC38140D100	46
36832CPS	40	2085399A01	45	3238020C27M	39	4038108C06	47	CC2C	13, 15
36834CPS	40	2085399A02	45	3238020C30M	39	4038108C07	47	CC2C_S	14
36836	40	2603393A03	12	3238020C33M	39	4038108C09	47	CC2C_T	12, 14
36838	40	2603973B02R	45	3238020C36M	39	4038108C11	47	CC6A_ _ _U	26
40063	40	2603973B02T	45	3593004M02M	47	4038108C12	47	CC6A_ _U	24
40114	40	2603989B01	45	3593008M02M	47	4038361C03CB	47	CC6A_U	25, 26
40151CPS	40	2604688B01B	12	3593012M02M	47	4038361C04CB	47	CC6C_ _T	24
40493CPS	40	2604688B02B	12	3593015M02M	47	4038361C05CB	47	CC6C_T	25, 27
40495CPS	40	2604688B03B	12	3593020M02M	47	4038361C10CB	47	CC6C_ _U	24
40517	40	2605670A02M	12	3593025M02M	47	4038380B03M	47	CC6C_U	25
				3593030M02M	47	4001177B51MC	47	CS	12, 13, 23, 24

Base Part Number	Page	Base Part Number	Page	Base Part Number	Page	Base Part Number	Page	Base Part Number	Page
CS125UFLTOOL	42	FEF083A040	13	JB135C1W3B	31	LPD625	19	SBE248422	61
CTM005A	34	FEF155A006	13	JB135C1W4B	31	LPF215H	11	SBE249830	61
CTM009A	34	FEF155A008	13	JB135C2B	31	LPF215U	11	SCHI	54
CTM010A	34	FEF155A010	13	JB135C2W	31	LPF215V	11	SCHIA	54
CTM011A	34	FEF155A012	13	JB135C2W1B	31	LPF225H	11	SCLO	54
CTM012A	34	FEF155A018	13	JB135C2W2B	31	LPF225U	11	SCLOA	54
CTM015A	34	FEF155A020	13	JB135C2W3B	31	LPF225V	11	SCVT	54
CTM019A	34	GE215-1Y06	43	JB135C3B	31	LPF235H	11	SCVTA	54
CTM020A	34	GE215-1Y06-K1	43	JB135C3W	31	LPF235V	11	SDOH	53
CTM024A	34	GE215-1Y06-K3	43	JB135C3W1B	31	L RTP615	25, 27	SEHI	53
CTM025A	34	GE215-2Y06	43	JB135C3W3B	31	L RTP625	25, 27	SEHIL	53
CTM029A	34	GE215-2Y06-K1	43	JB135C4B	31	L RTP635	25, 27	SELO	53
CTM030A	34	GE215-2Y06-K3	43	JB135C4W	31	O-62-21F	41	SELOL	53
CTM035A	35	GE225-1Y06	43	JB135C4W1B	31	O-62-50F	41	SFOC	53
DB635B150	45	GE225-1Y06-K1	43	JB135C5B	31	O-62F	41	SLHI	53
DBE635B150P	45	GE225-1Y06-K3	43	JB135C5W	31	O-63-21F	41	SLHIA	53
DB635B200	45	GE225-2Y06	43	JB135C6B	31	O-63-50F	41	SLLO	53
DB935B150	45	GE225-2Y06-K1	43	JB135C6W	31	O-63F	41	SLLOA	53
DB935B200	45	GE225-2Y06-K3	43	JBL25C2W1W	32	O-65-21FB	41	SMHI	53
DBA615	23	GE235-1Y06	43	JBL25C4W2B	32	O-65-50FB	41	SMLO	53
DBA625	23	GE235-1Y06-K1	43	JBL35C2W1W	32	O-65FB	41	SMRT	53
DBA635	23	GE235-2Y06	43	JBL35C4W2B	32	O-68-21FB	41	SP15	37
DBE625	25	GE235-2Y06-K1	43	JBS25C2B1W2B	33	O-68-50FB	41	SP25	37
DBE635	25	GS182422	61	JBS25C2W3B	33	O-68FB	41	SP35	37
DCEA635M27	39	GS183022	61	JBS25C2W3W	33	O-620-21F	41	SRPB	53
DCEA635M30	39	GS184822	61	JBS25C3W1B2W	33	O-620-50F	41	SSPL625A1	37
DCEA635M33	39	GS186622	61	JBS25C3W1W2B	33	O-620F	41	SSPL625A2	37
DCEA635M36	39	GS188422	61	JBS25C3W3W	33	OS50	41	SSPL625A3	37
DCP625A	25	GS189830	61	JBS25C4W4W	33	OS-620	41	SSPL625A4	37
DCP625C	25	GS302422	61	JBS35C2B1W2B	33	OSM004	35	SSPL635A1	37
DCP635A	25	GS303022	61	JBS35C2W3B	33	OTTQ615	25	SSPL635A2	37
DCP635C	25	GS304822	61	JBS35C2W3W	33	OTTQ625	25	SSPL635A3	37
DE225	15	GS306622	61	JBS35C3W1B2W	33	OTTQ635	25	SSPL635A4	37
DE225_T	14	GS308422	61	JBS35C3W1W2B	33	PDBA615	23	SSPLT615A1	37
DIP625A	25	GS309830	61	JBS35C3W3W	33	PDBA625	23	SSPLT615A2	37
DIP625AS	26	HD625	25	JBS35C4W4W	33	PDBA635	23	SSPLT615A3	37
DIP625C	25	HD635	25	JBY325C1W2B	32	PH13-4	41	SSPLT615A4	37
DIP635A	25	IBWP225	11	JBY325C1W3B	32	PISB625	23	SSPLT625A1	37
DIP635AS	26	ISB215	12	JBY325C3W	32	PISB625HP	23	SSPLT625A2	37
DIP635C	25	ISB225	12	JBY335C1W2B	32	PISB635	23	SSPLT625A3	37
DIPCAP	25	ISB235	12	JBY335C1W3B	32	PISB635HP	23	SSPLT625A4	37
DJ250-2	14	ISB625A	23	JBY335C3W	32	PK215	12	SSPLT635A1	37
DJ250-T2	14	ISB625C	23	KP3437322C1M	47	PK225	12	SSPLT635A2	37
DJ625A_	23	ISB635A	23	LBI215	11	PK235	12	SSPLT635A3	37
DJ625A2	27	ISB635C	23	LBI225	11	PKPB225	12	SSPLT635A4	37
DJ625C_	23	JB125C1B1W1B	31	LBITOOL	12	PLE225	11, 13	STAK	53, 54
DJ635A_	23	JB125C1B2W1B	31	LCN2CLJ615_ _SQB	19	PLEA225N03	39	STHI	53
DJ635C_	23	JB125C1B3W1B	31	LCN2DLJ615_ _ILB	19	PLEA225N06	39	STHIA	53
DLJ615A2	19	JB125C1B4W1B	31	LCN2CLJ625_ _SQB	19	PLEA225N09	39	STHIK	53
DPC625	23	JB125C1W2B	31	LCN2DLJ625_ _ILB	19	PLEA225N10	39	STHL	54
DPC625UT	23	JB125C1W3B	31	LCN2DLJ628_ _ILB	19	PLEA225N12	39	STLO	53
DPC635	23	JB125C1W4B	31	LCN2DLJ628_ _SQB	19	PLEA225N15	39	STLOA	53
DPC635UT	23	JB125C2B	31	LCN615	19	PLEA225N18	39	STLOK	53
DPD250	14	JB125C2W	31	LCN625	19	PLEA225N21	39	STUD635-A	25, 45
DPE250	14	JB125C2W1B	31	LCN628	19	PLEJ225	11, 13	STUD635-C	25, 45
DPS250	14	JB125C2W2B	31	LE215	11, 13	PLPC225	12	STUD-A	25, 26, 45
DRC250	14	JB125C2W3B	31	LE225	11, 13	POP615	23, 24	STUD-C	25, 26, 45
DS225	15	JB125C3B	31	LE235	11, 13	POP625	23, 24	STUD-T	25, 27, 37
DS225_T	14	JB125C3W	31	LEJ215	11, 13	POP635	23, 24	STUD-U	25
DT625	25, 26, 27	JB125C3W1B	31	LEJ225	11, 13	PS625CLEER	19	STVT	53
DT635	25, 26, 27	JB125C3W3B	31	LFEP215	13	PS625CLEERDM	19	STVTA	53
FECC	13	JB125C4B	31	LFEP215TFEC	11	RH15-10	41	TP615	23, 24, 27
FEF083A006	13	JB125C4W	31	LFEP225	13	SA	12, 13, 23, 24	TP625	23, 24, 27
FEF083A008	13	JB125C4W1B	31	LFEP225TFEC	11	SBE182422	61	TP635	23, 24
FEF083A010	13	JB125C5B	31	LF215	11	SBE183022	61	TQHD625	25
FEF083A012	13	JB125C5W	31	LF225	11	SBE184822	61	TQHD635	25
FEF083A018	13	JB125C6B	31	LJ215C-	11	SBE186622	61	TWRENCH	25
FEF083A020	13	JB125C6W	31	LJ225C-	11	SBE188422	61	UOP625	23
FEF083A025	13	JB135C1B1W1B	31	LJ235C-	11	SBE189830	61	WH3	41
FEF083A030	13	JB135C1B2W1B	31	LPC215	11	SBE242422	61	WS12	34
		JB135C1B3W1B	31	LPC225	12	SBE243022	61	WS1112	34
		JB135C1B4W1B	31	LPC235	12	SBE244822	61	WS1118	34
		JB135C1W2B	31	LPC615	19	SBE246622	61		



We make what matters work.*

EATON

Powering Business Worldwide



* Every day, people depend on things like technology, transportation, energy and infrastructure to keep their daily lives on track. But without power, none of it would be possible. That's why companies around the world turn to Eaton. We're dedicated to improving people's lives and the environment with innovative technologies

that help manage power more safely, reliably and sustainably. To meet today's challenges, and tomorrow's. Because this is what really matters. And we're here to make sure it works.

**To learn more go to:
[Eaton.com/WhatMatters](https://www.eaton.com/WhatMatters)**

We make what matters work.

Product application overhead/underground distribution systems

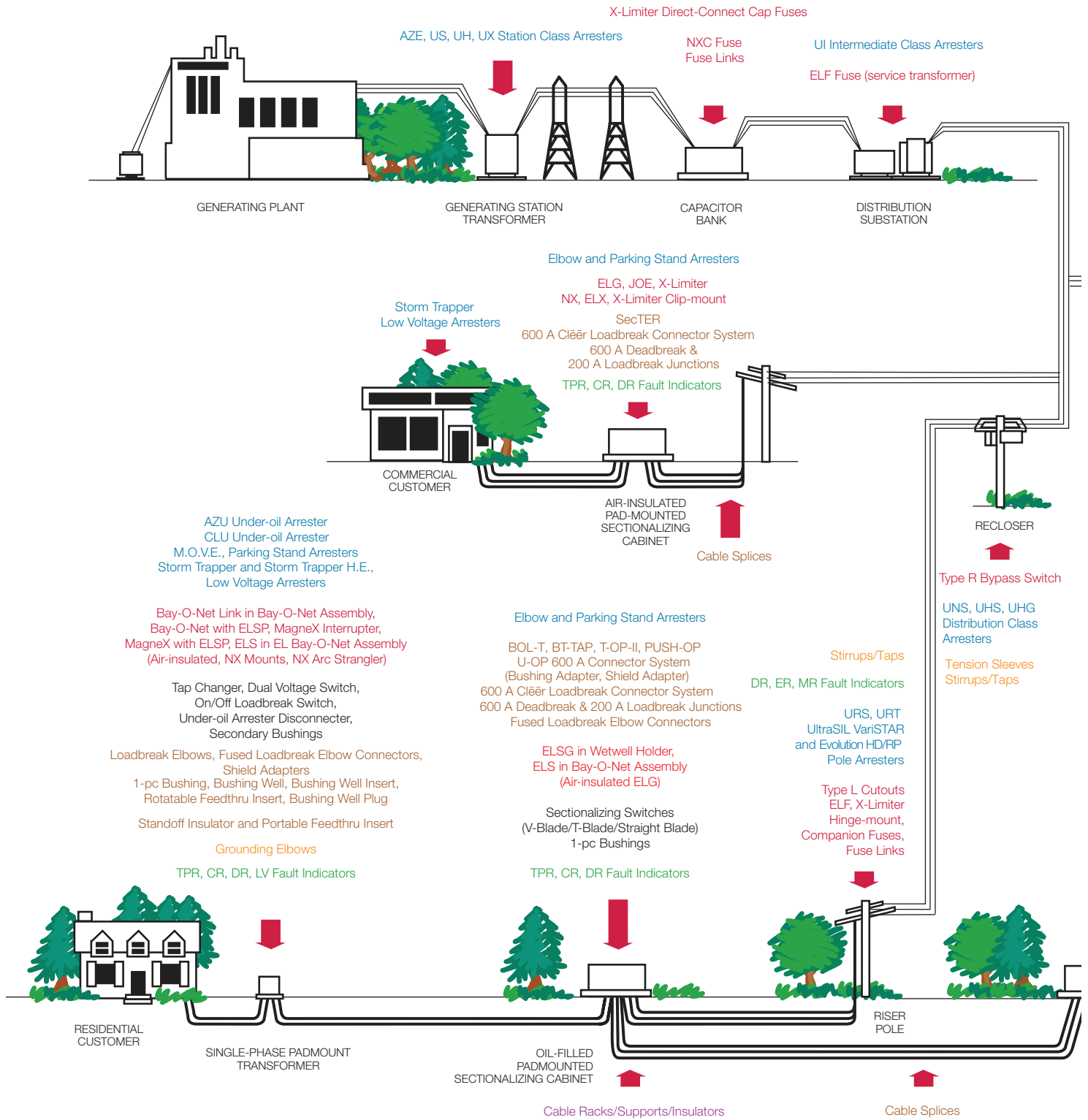

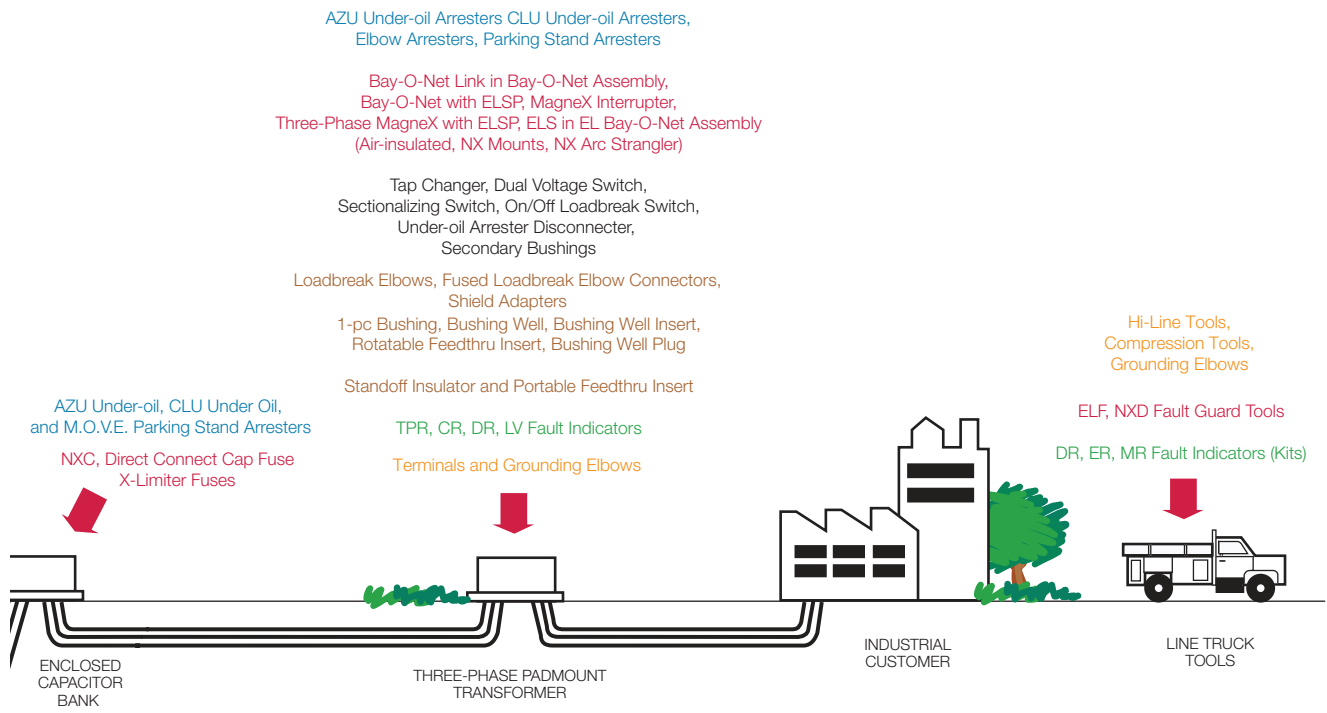
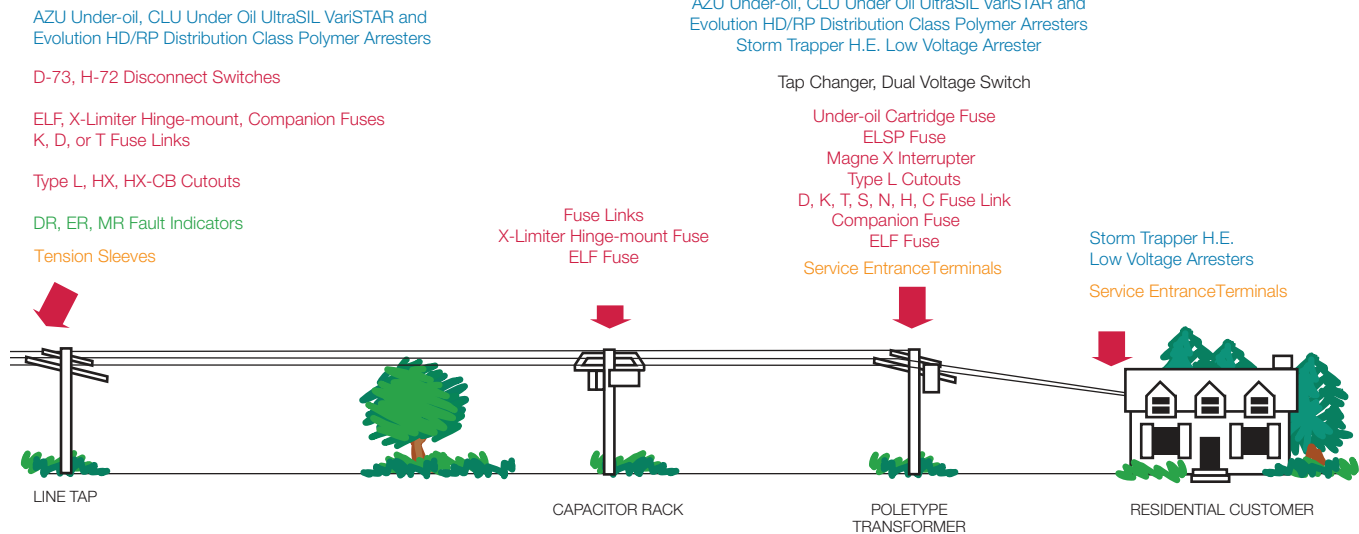

Eaton
1000 Eaton Boulevard
Cleveland, OH 44122
United States
Eaton.com

Eaton's Power Systems Division
2300 Badger Drive
Waukesha, WI 53188
United States
Eaton.com/cooperpowerseries

© 2019 Eaton
All Rights Reserved
Printed in USA
Publication No. BR100003EN
May 2019
Supersedes November 2016

Eaton is a registered trademark

All trademarks are property of their
respective owners.

For Eaton's Cooper Power series
product information call
1-877-277-4636 or visit
www.eaton.com/cooperpowerseries.

Follow us on social media to get the
latest product and support information.

