

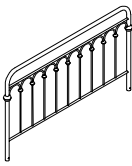

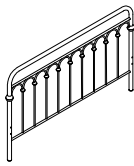

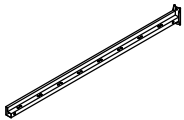
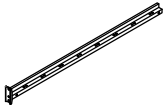
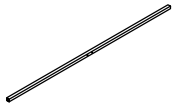
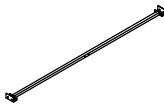
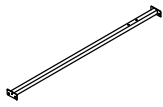
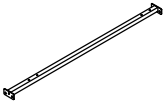
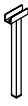

ASSEMBLY INSTRUCTION

METAL ARCH DESIGN FULL PLATFORM BED

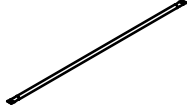
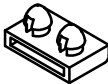
A Headboard Leg  2PCS	B Headboard  1PC	C Footboard  1PC	D Front Rail Section  2PCS
E Rear Rail Section  2PCS	F Front / Rear Support Bar  2PCS	G Center Support Bar  1PC	H Front Center Rail  1PC
I Rear Center Rail  1PC	J Support Leg  2PCS	K Center Support Leg  3PCS	L Slat  16PCS
M Slat Connector  32PCS	N Bolt 1/4"*16mm  30PCS	O Bolt 1/4"*46mm  8PCS	P Bolt 1/4"*36mm  2PCS
Q Nut 1/4"  6PCS	R Ratchet Tool 4mm  1PC	S Wrench 5/16"-1/4"  1PC	

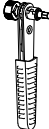
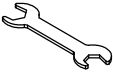
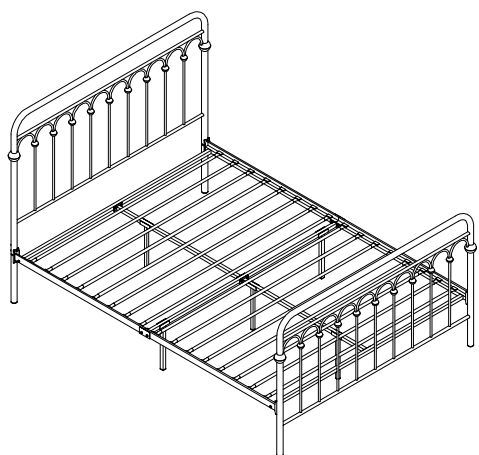

This page lists all the contents included in the box. Please take the time to identify the hardware as well as the individual components to this product. As you unpack and prepare for assembly, place the contents on a carpeted or padded area to protect them from damage.

How to Use the Ratchet Tool (R)

1. Before assembling the furniture, please adjust the lock as needed.

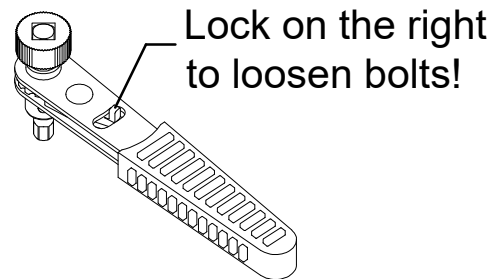
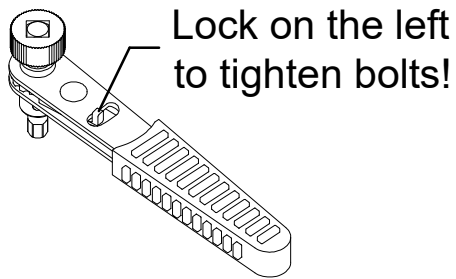

2. Tighten or loosen bolts.

- **Tighten bolts:** Locate the turncap and rotate it clockwise to screw the bolt quickly until it cannot be rotated any more. Then start rotating the handle clockwise to finalize tightening the bolt.

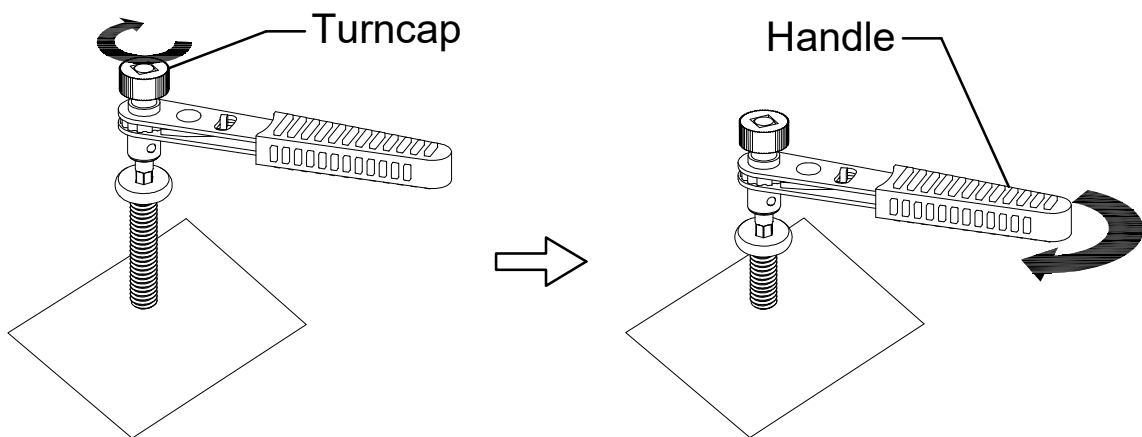

- **Loosen bolts:** Rotate the handle counterclockwise to loosen the bolt. Then continue rotating the turncap in the same direction to remove the bolt completely.

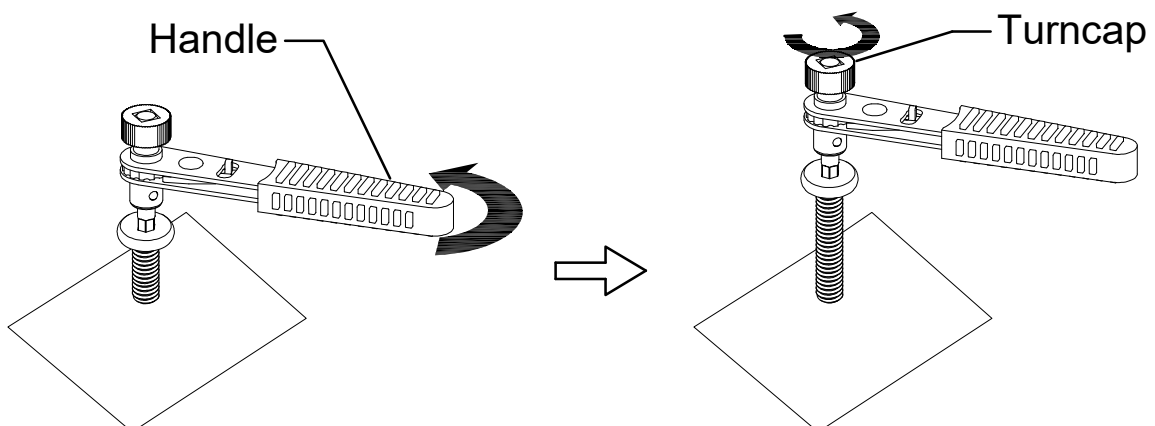

1

Attach the Headboard Leg (A) to the Headboard (B), insert the Bolt (N), turn the Ratchet Tool (R) to tighten them.

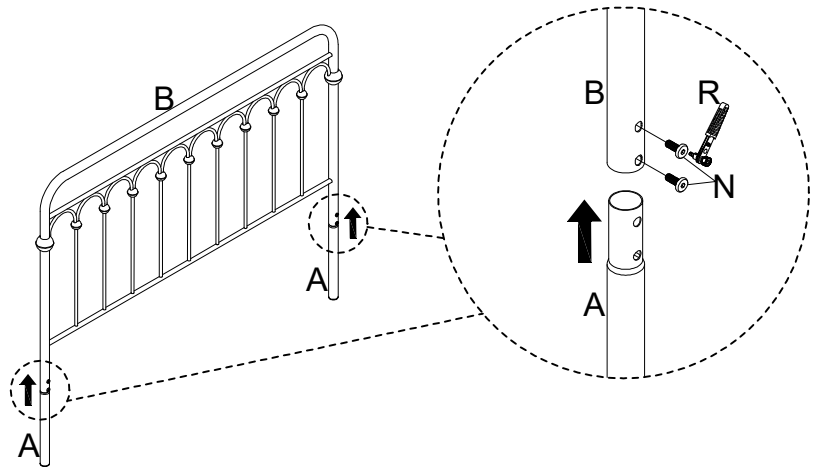
**2**

Attach the Front Rail Section (D), Rear Rail Section (E) and Center Support Bar (G), insert the Bolt (N), Bolt (O) and Nut (Q), turn the Ratchet Tool (R) and Wrench (S) to tighten them.

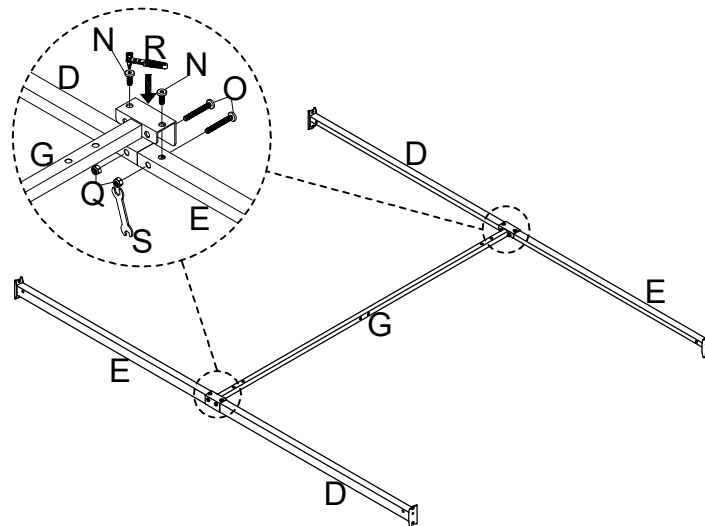
**3**

Attach the Support Leg (J) to Center Support Bar (G), and then insert the Bolt (N), turn the Ratchet Tool (R) to tighten them.

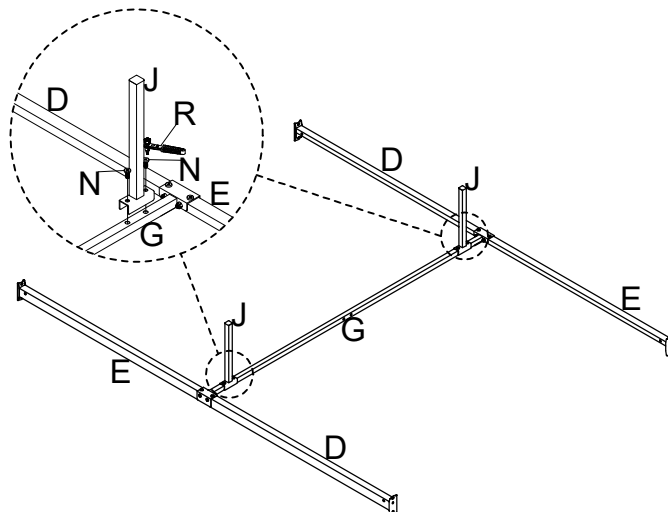

4

Attach the Front / Rear Support Bar (F) to rails, insert the Bolt (O), turn the Ratchet Tool (R) to tighten them.

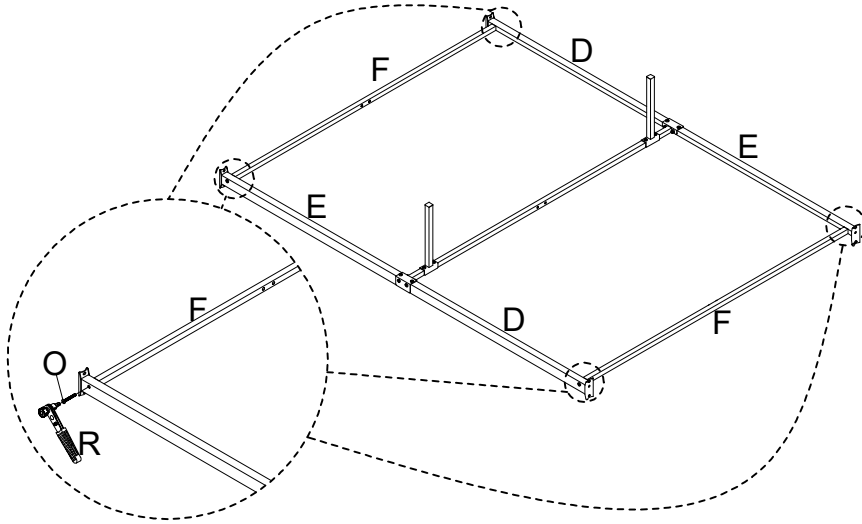
**5**

Attach the Front Center Rail (H) and Rear Center Rail (I) to the Front / Rear Support Bar (F) and Center Support Bar (G), insert the Bolt (N), turn the Ratchet Tool (R) to tighten them. Insert the Bolt (P) and Nut (Q), turn the Ratchet Tool (R) and Wrench (S) to tighten them.

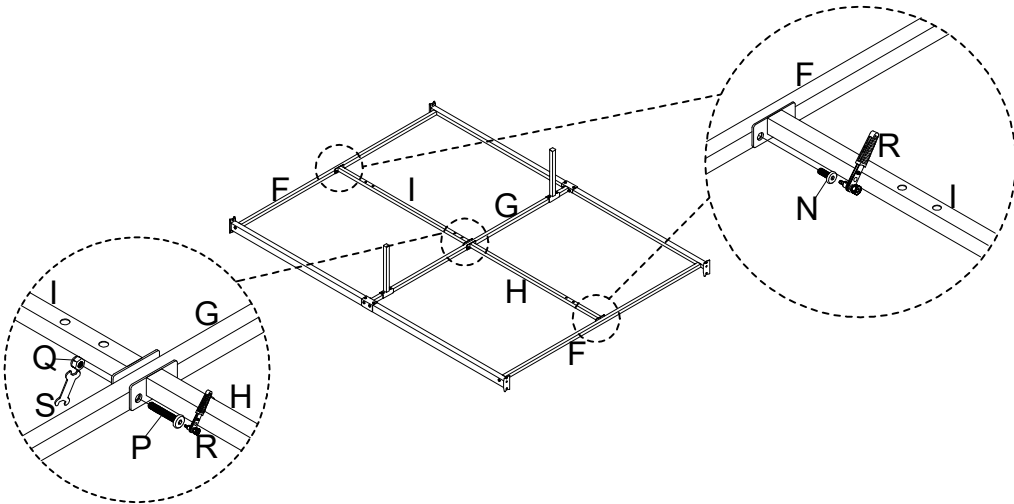
**6**

Attach the Center Support Leg (K) to the center rails, insert the Bolt (N), turn the Ratchet Tool (R) to tighten them. After the assembly, flip them over.

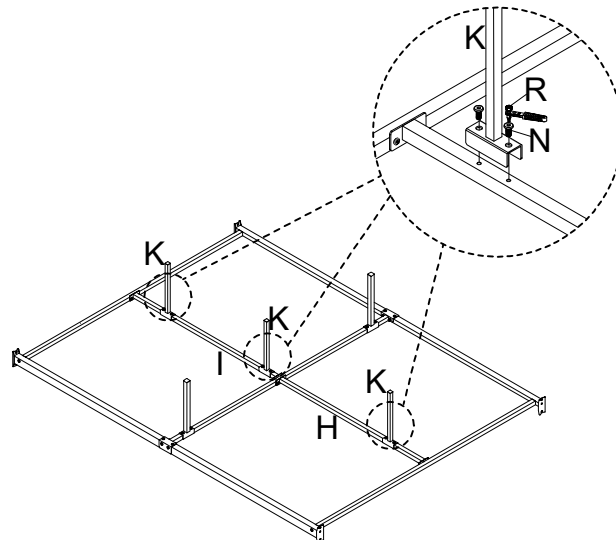

- 7** Attach the assembled metal frame to the Headboard Leg (A), Headboard (B) and Footboard (C), insert the Bolt (N), turn the Ratchet Tool (R) to tighten them.

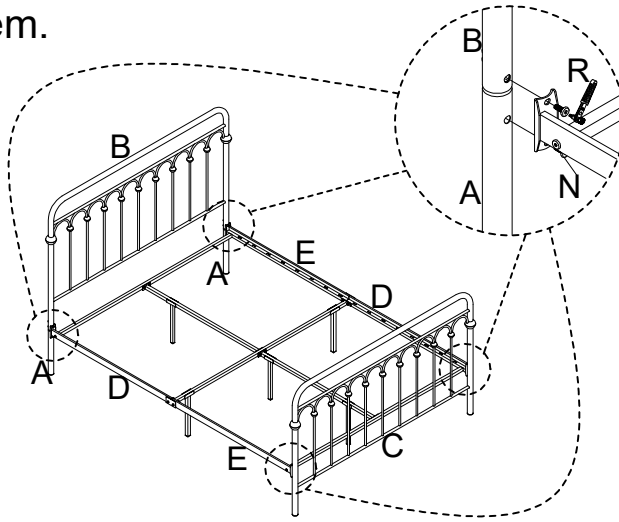

- 8** Insert the Slat Connector (M) to the both sides of Slat (L), press the Slat (L) into the correct place.

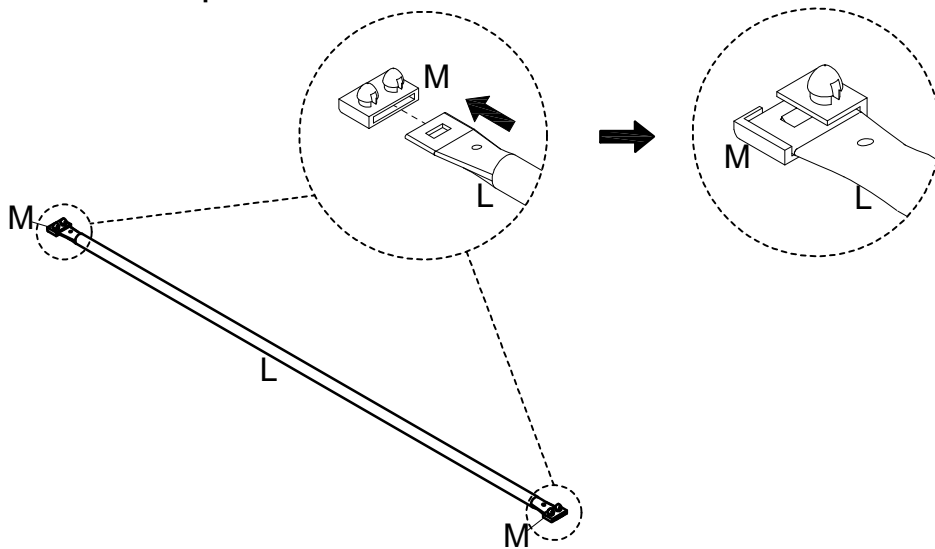

- 9** Attach the Slat (L) to rails, put the Slat Connectors (M) into the correct places and press them down.

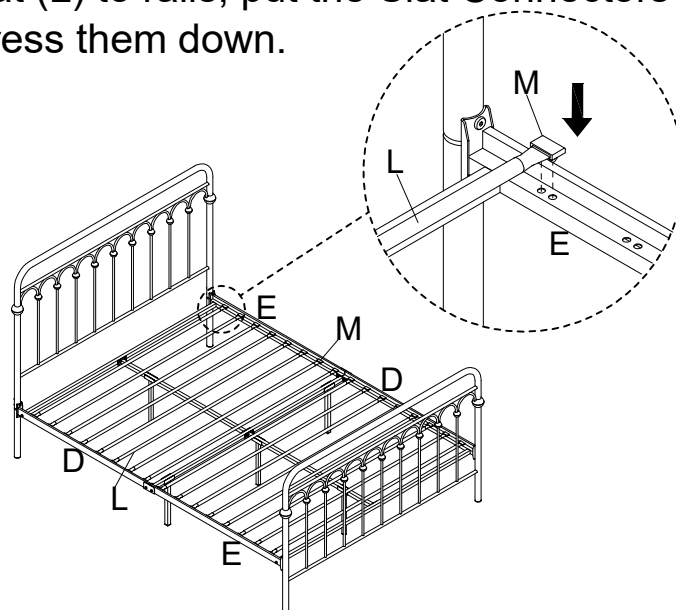

Cleaning & Care

Treat surface with care. Surface is resistant to scratches but is not scratch resistant. Clean surfaces with a dry or damp soft cloth. Do not use abrasive cleaners. Hardware may loosen over time. Periodically check that all connections are tight.