

ASSEMBLY AND INSTALLATION INSTRUCTIONS

T0620

WARNING: TO AVOID RISK OF ELECTRICAL SHOCK, BE SURE TO SHUT OFF POWER BEFORE INSTALLING OR SERVICING THIS FIXTURE.

- NOTES:**
1. Before installing, consult local electrical codes for wiring and grounding requirements.
 2. To see App and Voice Control setup video tutorials visit the Vaxcel Lighting YouTube channel or vaxcel.com/inspiration/resources/.
 3. READ AND SAVE THESE INSTRUCTIONS.

Hardware Package (included):



Mounting Screw X2
#8/32 X 1/2 in



Mounting Screw X2
#6/32 X 1/2 in



Mounting Screw X2
#10/24 X 1/4 in

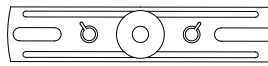

Mounting Strap



Decorative cover



Fixture Mounting Screw

Tools Needed:

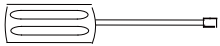

(1) Phillips-head Screwdriver

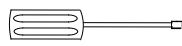

(2) 1/8" wide Flat-head Screwdriver

1. Phillips-head screwdriver for attaching mounting screws to mounting strap, mounting bracket and fixture to mounting bracket.
2. 1/8" wide flat-head screwdriver for connecting the source wires into the wiring terminal station on the mounting bracket.

Important to Know:

1. If you are not familiar with state and local electrical codes, it is recommended that you consult with a qualified electrician.
2. This fixture requires a 120 VAC, 60 Hz power source.
3. For general safety and to avoid any possible damage to the sensor, be sure the power is switched "off" before adjustment.

Maximum Wattage: 28 W

Working Temperature Range: -13°F ~ 113°F

Features:

1. Energy saving LED fixture.
2. Motion sensor: turns light ON at full brightness automatically when motion is detected and DIMS light to low level brightness automatically when motion stops.
3. Photocell automatically keeps the light OFF during daylight hours and automatically turns the light ON during evening hours.

Note: Fixture can be wall mounted or eave mounted.

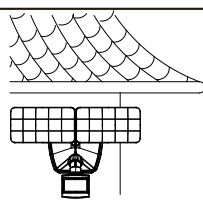

Wall Mounted

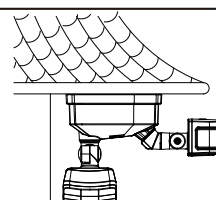

Eave Mounted

Read notes section on page 3 for additional information about mounting location of fixture.

Light fixture and sensor should be mounted as shown above when installed (depending upon type of installation)

Before installing the light fixture under an eave, the sensor head must be rotated as shown in the next two steps for proper operation and to avoid the risk of electrical shock.

For eave mounted only:

- Swing the sensor head towards the mounting bracket.

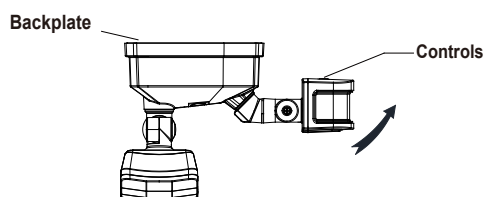

- Rotate the sensor head clockwise 180° so the controls face down.

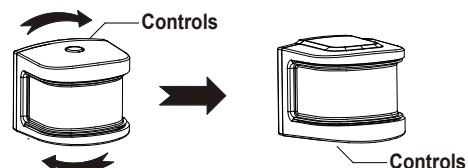

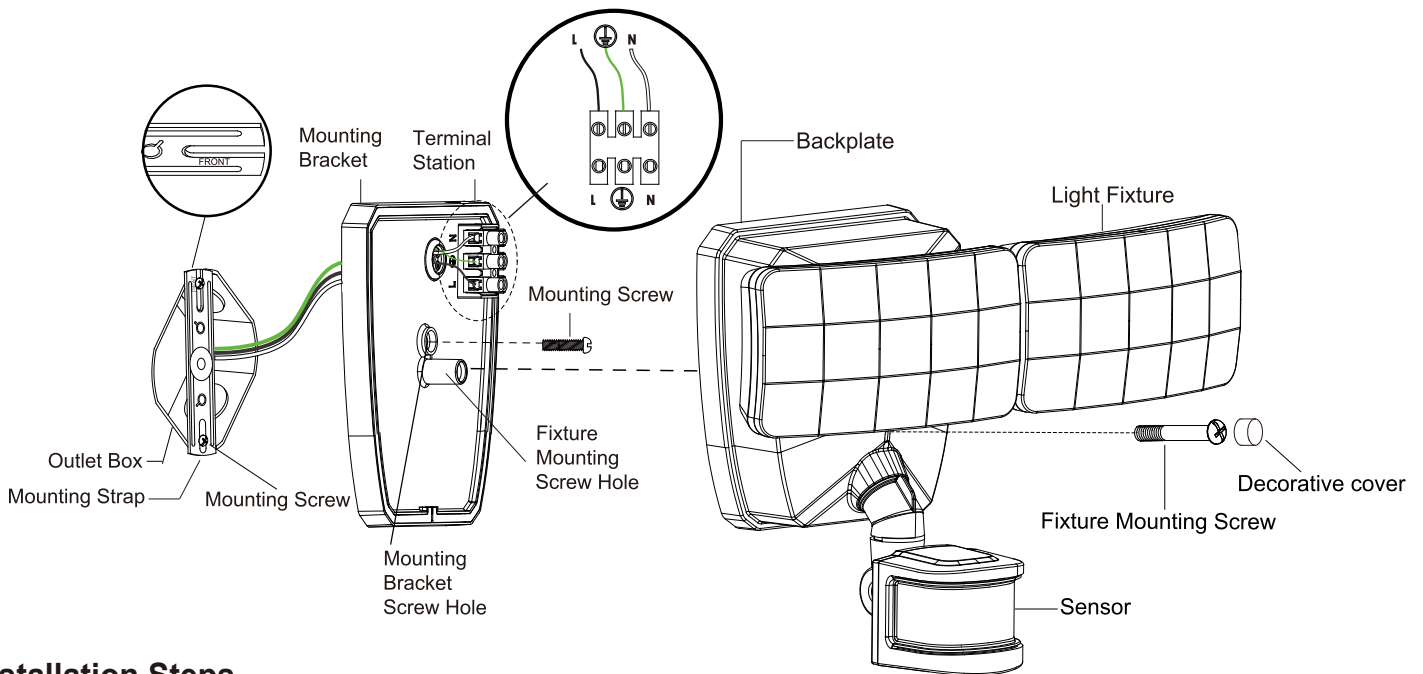

Installation Steps

Turn off the power at fuse or circuit box.

1. The fixture mounting bracket is pre-assembled on the light fixture. Unscrew both the decorative cover and the fixture mounting screw in order to remove the mounting bracket.
2. Install the mounting strap to the outlet box with the stamped word "FRONT" facing away from the outlet box, using two mounting screws that best fit the outlet box. Mounting bracket should sit flush against wall surface when secured. (Choose one matching pair of suitable mounting screws from the 3 pairs provided).
3. Pull out the source wires from the outlet box. Using a 1/8" flat-head screwdriver connect the black wire from the outlet box to the "L" interface of the terminal station on the mounting bracket. Connect the white wire from the outlet box to the "N" interface of the terminal station on the mounting bracket. Connect the Ground wire from outlet box to "⊕" interface of the terminal station on the mounting bracket. Carefully tuck the wires back into the outlet box.
4. Place mounting bracket against the outlet box, insert the mounting bracket screw through the mounting bracket hole, thread mounting bracket screw into the center hole of the mounting strap. Tighten the mounting bracket screw securely.
5. Attach the backplate of the light fixture to the mounting fixture mounting screw. Then push the decorative cover firmly into the fixture mounting screw hole on the light fixture. Tighten the fixture mounting screw securely.
6. With silicone caulking compound, caulk completely around where the back plate meets the wall surface.
CAUTION: Be sure to caulk completely where the back plate meets the wall surface to prevent water from seeping into the outlet box.

Turn on the power at the main fuse or circuit breaker box.

Adjusting the Sensor Head:

1. Aim sensor head toward desired detection area, maintaining a 5° - 40° downward angle to allow moisture to drain.
 Note: Make sure sensor head is positioned with control knob facing towards the ground.
2. You can rotate the sensor head up and down to change the coverage area. (See Fig. 1)
Note: Range set too high may increase false triggering.
 (See Fig. 2 and Fig. 3)

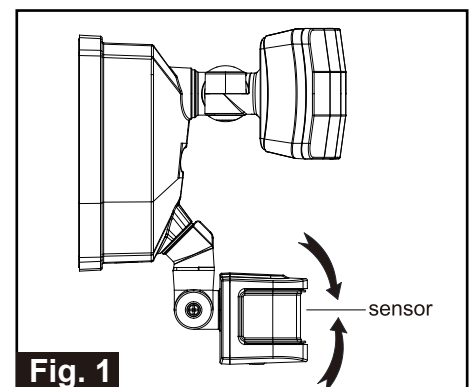

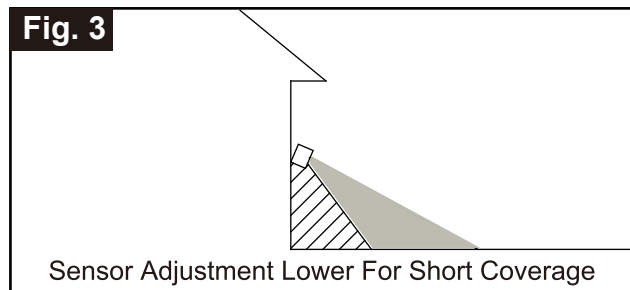
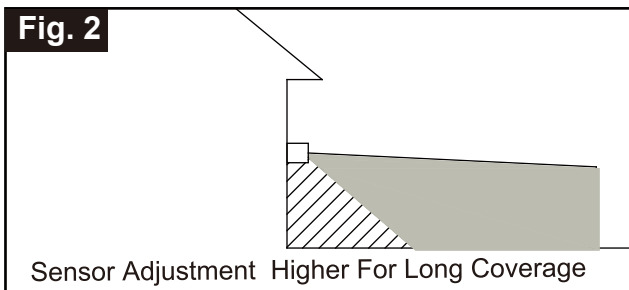

Adjusting the Light Head:

1. Gently grasp the light heads and tilt them up or down, left or right to adjust the light coverage area. Keep the light heads at least 1" (25mm) away from the sensor. (See Fig. 4)
2. Keep the light heads 30° below horizontal to avoid water damage and electrical shock.

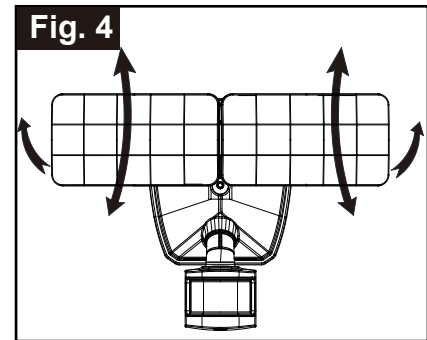

Notes:

1. The sensitivity of the motion sensor will increase as the environmental temperature gets cooler. For best performance, gently clean the lens with a soft cloth every 1 or 2 months to ensure maximum sensitivity.
2. For best performance, install fixture at least 8 feet above the ground. At such a height, the fixture will provide a detection distance of up to 70 feet at 77 degrees Fahrenheit. (See Fig.5)
3. The sensor detects movement across a detection range of 240 degrees. (See Fig.6)
4. The sensor will be more sensitive to motion across its detection path than motion directly towards it. (See Fig.7)
5. To reduce possible nuisances, do not mount the fixture near a heat source like an air conditioner, vent or furnace exhaust, or in a direction facing any reflective object or other nearby light source.

Where you install your fixture is important:

Be sure the light is mounted straight on the wall or eave; otherwise, the detection distance may be limited.

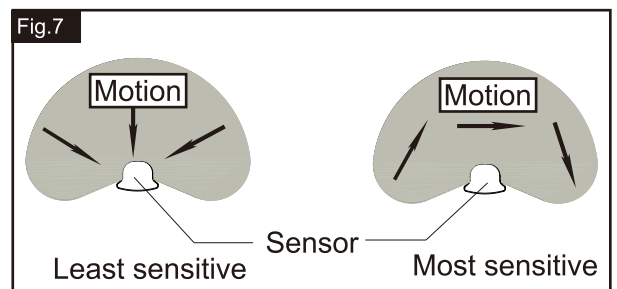
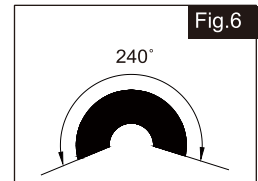
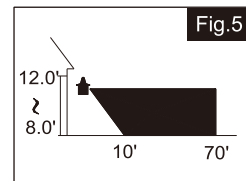

USER GUIDE

Setting for single light through mobile device (Take iOS for example as below. Android will be slightly different).

Note: When power is first applied, the light will turn on to 100% brightness.

The sensor will take 45 seconds to warm up.

Before you start

1. For Apple IOS devices search "DualuxBT" in App Store.
For Android devices search "Dualux" in Google Play.
Install the APP onto the device.



2. Open the App and click "WIFI".



3. Select "Register" for new accounts or "Login" for existing accounts.

Note: For existing accounts skip to step 6.



4. Enter email address, then select "Next".

Note: You will receive an email sent by noreply@ls-dg.net. Within you will find a link to receive the verification code.

Check Spam folder if verification email is missing from inbox.



5. Enter the verification code sent to your email, set password, then select "Register".

Note:
Device location setting must be turned on.



6. Select "Security Light", then select "ADD".



USER GUIDE (continued)

7. Select T0620.

Note: Two methods are provided for connecting and setting up your new security light.

The primary and recommended method is the AP Mode Connect setup. The secondary method is the Smart Connect setup, which is not compatible with all WiFi routers/mesh networks.

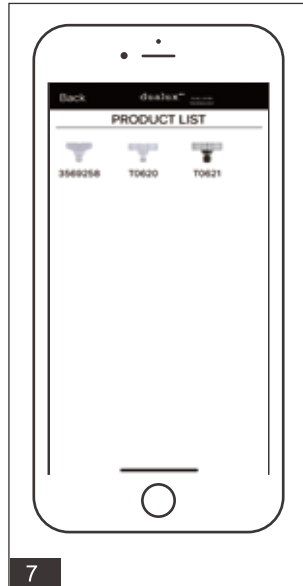

8. In AP CONNECT Turn power on for the light. Press the "RESET" button on the light 3 times within 5 seconds. The Red indicator light will slowly flash. Select "Next" on your device to proceed.

Note: The red light for AP Connect will blink slower than Smart Connect, after pressing "RESET" quickly 3 times.



9. Select a 2.4GHz WiFi network, enter the WiFi password, then select "Confirm".

Note: Must be synced with a 2.4GHz WiFi network.

Routers that use both 2.4GHz and 5GHz on the same network may need to have 5GHz frequency temporarily turned off for setup.



10. Go to device Settings, WiFi setup. Connect to the light WiFi (HF-XXXXXX). Select "Set WiFi".

Note: Do not close the App.



11. Return to the App. Within a few seconds, the App will start the connection process.

The status window will appear once the device has successfully connected and the 3 bullet points have a check mark.

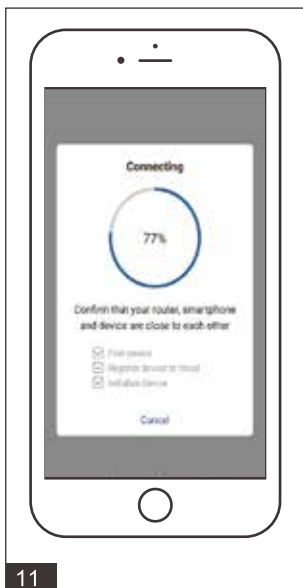

12. For successful connection, select "Confirm" and proceed to step 13.

For unsuccessful connection "Failure", select "Confirm". Retry AP Connect setup or proceed Smart Mode setup in figure 12.1.



12.1 Select Smart Mode

Note: Ensure the Location setting on your device is turned on.

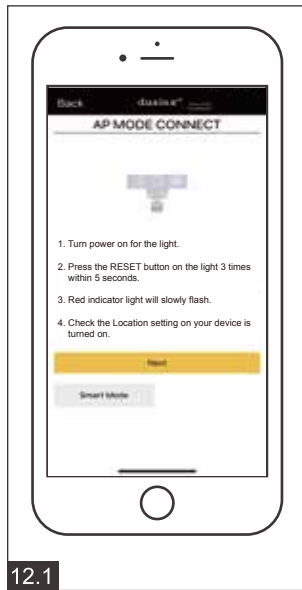

12.2 In SMART CONNECT, turn power on for the light. Press and hold "RESET" button on the light for 5 seconds, until the color on the light changes to warm 2200K, then release. Wait while the Red and Blue indicator light flashes during warm up. After warm up, the Red indicator light will steadily flash await for connection. Select "Next" on APP to proceed

Note: Only works with 2.4GHz WiFi networks.



12.3 Select a 2.4GHz WiFi network, enter the WiFi password, then select "Confirm".

Note: Must be synced with a 2.4GHz WiFi network.

Routers that use both 2.4GHz and 5GHz on the same network may need to have 5GHz frequency temporarily turned off for initial connection.



12.4 The status window will appear once the device has successfully connected and the 3 bullet points have a check mark.



13. To adjust light functions and settings select the "Security Light 1" with a  icon on the side.

Note: A solid blue light on the sensor indicates a network connection.



13

14. In Settings, you can set "Functions", turn off/on sensor "Indicator Light", "Rename Light", "Remove Light", and check WiFi network connection and signal quality in "Wifi Info".



14

15. Select "Functions" to adjust the light features

Test Mode:

"High Level Time" is set at 5 seconds and cannot be adjusted. All day and night operation.

Auto Mode:

Ability to set "High Level Time".

Custom Mode:

Set duration of Early Evening feature where light is set at "High Level" with no motion. After specified amount time, the light will begin motion detection.

D2D Mode:

Dusk to dawn illumination without motion detection.

15.1 Test Mode (Daytime and Nighttime Operation):

- * Select the "TEST" tab in "Functions".
- * The light turns to high level brightness (50%~100%) and CCT Color(2200K~5000K) when motion is detected and stays on as long as the motion continues. The light reverts to low-level brightness (0~50%) and CCT color (2200K~5000K) as set, about 5 seconds after motion is no longer detected.



15.1

15.2 Auto Mode (nighttime operation only):

- * Select "AUTO" tab in "Functions".
- * Select the High Level Time to the desired shut-off delay time setting (30s~20min).
- * At dusk, the light turns on to selected low level brightness (0%~50%) and CCT Color (2200K~5000K). When motion is detected, the light turns to high level brightness (50%~100%) and CCT Color (2200K~5000K) and stays on as long as motion continues.
- * When the motion is no longer detected, the light will remain on at high level brightness (50%~100%) and CCT Color (2200K~5000K) for the High Level Time selected (30s~20min), then automatically switches back to selected low level brightness (0~50%) and CCT (2200K~5000K).
- * At dawn, the light turns off.

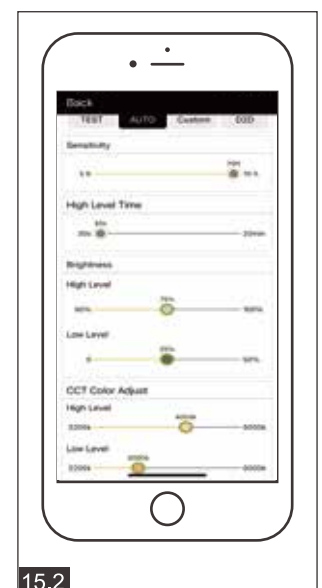

15.2

15.3 Custom Mode(nighttime operation only):

- * Select the “Custom” tab in “Functions”.
- * Customize Early Evening Mode:
 - * Select the “Duration After Dusk” (1~12 hours). The light will transition to late night setting and initiate motion sensor operation after this time. For the initial selected (1~12 hours) the light turns to high level brightness (50%~100%) with no motion.
 - * Select the “Clock Time (Start – End)” to set a specific time for the light to transition into late night setting and initiate motion sensor operation. The light will remember that time and go into late night setting/motion-sensor operation at that specified time every night. The light will remain at high level brightness with no motion detection, but after the end time then late night mode with motion detection will begin.
 - * For example, a homeowner wants to have the light stay on at high level settings from dusk to 8pm and transition to late night/motion detection mode from 8pm until dawn. To achieve this, set the end time at 8pm. This sets the time the light goes into late night/motion sensor mode every day at 8pm.
- * Select the High Level Time to the desired shut-off delay time setting (30s~20min).
- * At dusk, the light turns on to selected low level brightness (0%~50%) and CCT Color (2200K~5000K). When motion is detected, the light turns to high level brightness (50%~100%) and CCT Color (2200K~5000K) and stays on as long as motion continues.
- * When the motion is no longer detected, the light will remain on at high level brightness (50%~100%) and CCT Color (2200K~5000K) for the High Level Time selected (30s~20min), then automatically switches back to selected low level brightness (0~50%) and CCT (2200K~5000K).
- * At dawn, the light turns off.



15.4 D2D Mode(nighttime operation only):

- * Select the “D2D” Dusk-to-Dawn tab in “Functions”.
- * At dusk, the light turns to high level brightness (50%~100%) and CCT Color (2200K~5000K).
- * At dawn, the light turns off.



USER GUIDE (continued)

16. In SETTINGS, you may also check or update 4 other settings

- * Indicator Light (Turn On/Off sensor indicator light)
- * Rename Light (Update the name of the light)
- * Remove Light (Remove the light from APP)
- * WiFi Info (Check current WiFi signal strength)



16

16.1 To turn the sensor indicator light On/Off select "Indicator Light".

Note: A solid blue light on the sensor indicates a network connection.



16.1

16.2 Select "Rename Light" to change the name. After entering the name, select "OK" and the name of the light will be updated accordingly.



16.2

16.3 To remove the light from the App, select "Remove Light" and select "OK" to complete.



16.3

16.4 Select WiFi Info to view the WiFi signal strength on your light.

Note: The light must maintain a minimum 75% signal strength for a stable connection.



16.4

17. In the DEVICE LIST screen, you can select "Grouping" to synchronize multiple security lights.

In the GROUP LIST screen, select "ADD" to create a new group.

Enter a group name and select "OK" to create.

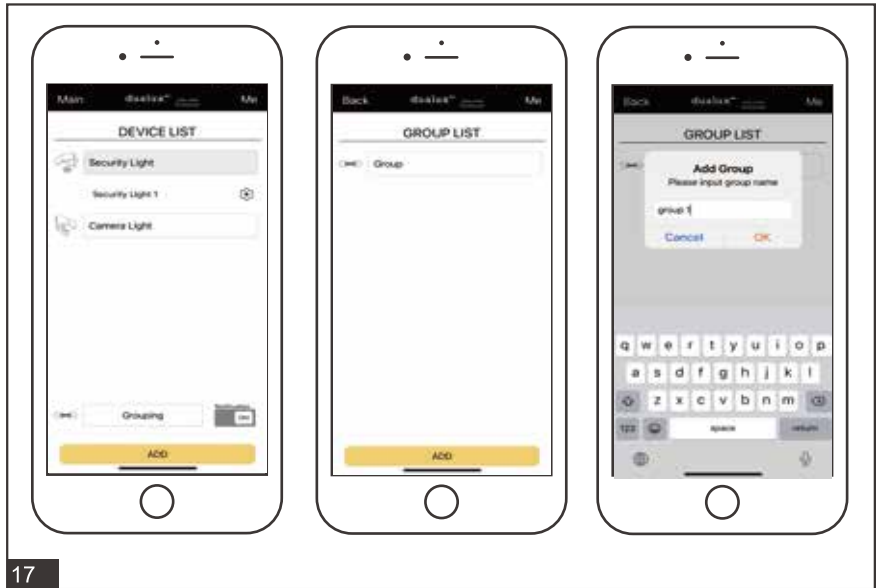

17

17.1. Once the group has been created, select the name of the group to enter the group synchronizing screen. Within the group screen, it will show all the lights that are connected to the internet awaiting to be linked.

For each light there are 2 boxes on the right: "SYNC" represents motion sensing signals.

Select the "SYNC" box, which will change to gray. This will send motion sensing signals to all grouped lights and motion will be activated on all lights when motion on one light is sensed.

"D2D" represents dusk to dawn signals.

Select the "D2D" box, which will change to gray. This will send dusk to dawn signal to all lights, which will together turn on at dusk and off at dawn.

Note:

Select "Save" to finalize all changes.



17.1

17.2. Other group settings can also be adjusted by clicking the gear icon in the "Group List" screen.

Functions:

Select functions to adjust light features in the group. Reference step 14.

Indicator Light:

Select to turn On/Off sensor indicator light for all lights in the group. Reference step 15.1.

Rename Group:

Select to update the name of the light group.

Remove Group:

Select to remove the group.

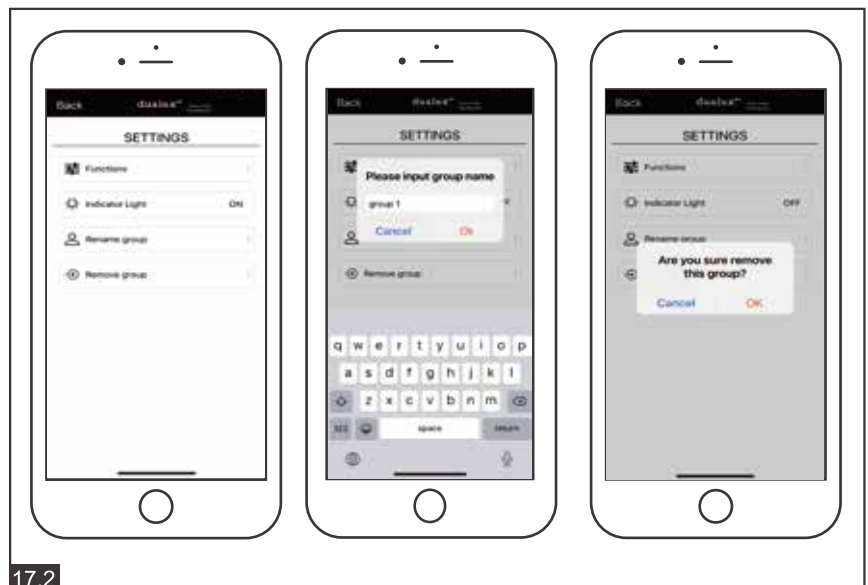

17.2

Voice Command Control

Manual Override (Daytime Voice):

“Turn on (Light Name)”. The light will turn on and remain at high level until dusk. At dusk the light will default to selected mode(Test, Auto, Custom, D2D).

Note: In Custom mode the light will remain at High Level for pre-selected amount of time in the App.

Manual Override (Nighttime Voice):

“Turn on (Light Name)”. The light will turn on and remain at high level until dawn. At dawn the light will turn off, then at dusk default to selected mode(Test, Auto, Custom, D2D).

CCT Color Change (High Level & Low Level Sync):

“Set (Light Name) Warmer [or Cooler]” to adjust the CCT Color by 500K between 2200K(Warmest) and 5000K(Coolest).

“Set (Light Name) to (Warm White, Soft White, White or Daylight) to match popular colors. Warm White(2200K), Soft White(2700K), White(4000K), Daylight(5000K).

Note: CCT Color will change from the High Level setting. Both High Level and Low Level will adjust to match the new color setting. This will change the default CCT Color in all modes.

Adjust High Level Brightness (51%-100%):

“Set (Light Name) to (51%-100%)” to set High Level brightness.

Note: This will change the default brightness in all modes.

Adjust Low Level Brightness (0%-50%):

“Set (Light Name) to (0%-50%)” to set Low Level brightness.

Note: This will change the default brightness in all modes.



Alexa voice commands that work to control your security light.
Note: “security light” is an example name but Alexa will use the “Light Name” set in the “Dualux” or DualuxBT” app.

Manual Override:

Alexa, turn on security light.

Alexa, turn off security light.

Adjust Brightness:

Alexa, set security light to (0-100%).

Alexa, brighten security light.

Alexa, dim security light.

Adjust Color Temperature:

Alexa, make security light warmer.

Alexa, make security light cooler.

Alexa, set security light to warm white.

Alexa, set security light to soft white.

Alexa, set security light to white.

Alexa, set security light to daylight



Connecting to Alexa

- 1. Start the Alexa App then select the “Menu”  .

Note: Search “Amazon Alexa” in Google Play or Apple App Store to download.

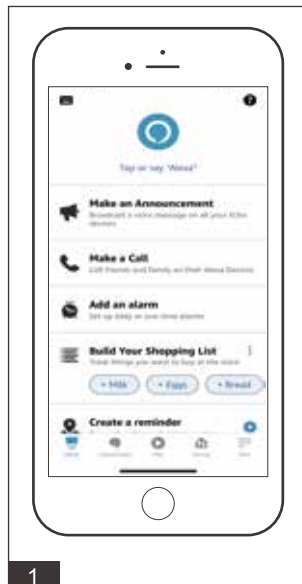

- 2. Select Skills & Games.



USER GUIDE (continued)

3. In the Search menu, type "Innovation & Perfect", then select "Innovation & Perfect" below.



4. Select "ENABLE TO USE".

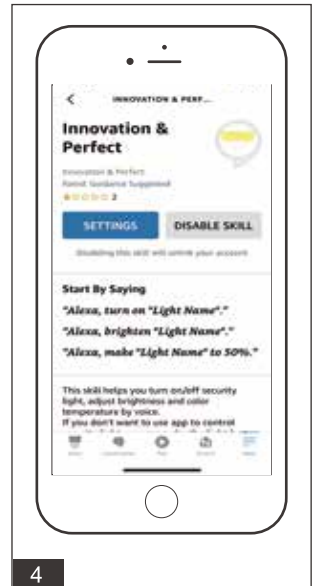

5. Login using the same username and password that you have registered in the "Dualux" or "DualuxBT" App. Then select "Login".



6. Once "Successfully linked" appears, select CLOSE.

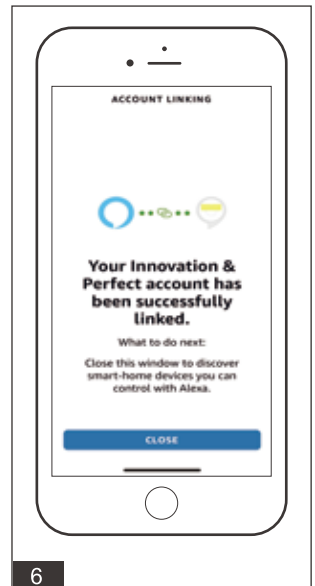

7. Select "DISCOVER DEVICES".



8. Discover for up to 45 seconds.

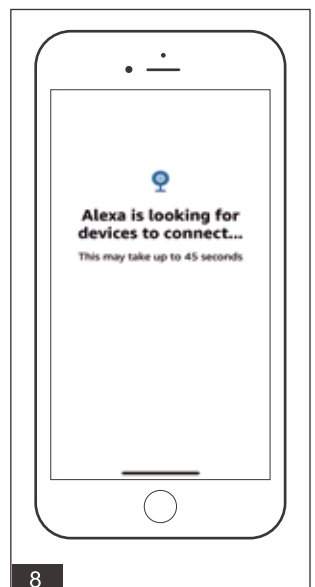

USER GUIDE (continued)

9.1 If initial device discovery fails, return to main screen and select "More", then select "Add a Device".



9.2 Select "Light".



9.3 Drag down and select "Other".

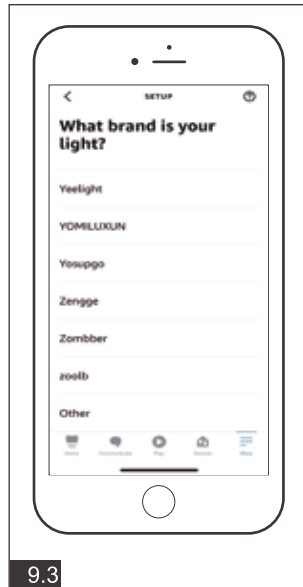

9.4 Select "Discover Devices".

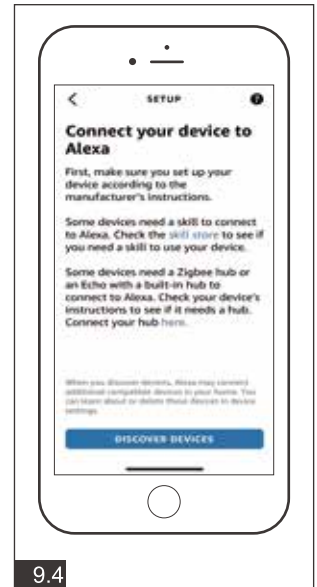

10. When light is discovered click "set up device".

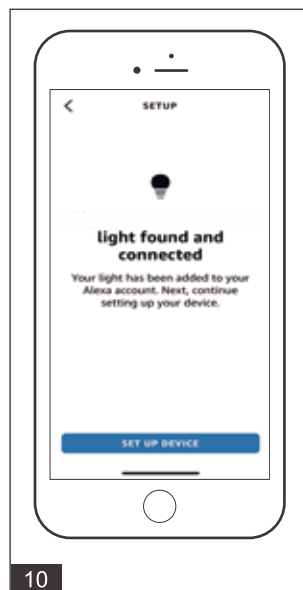

11. Select a group. For example, "Outdoor Lights".

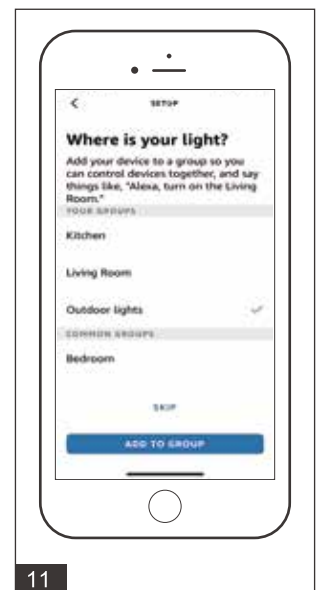

12. Light is added to a group.

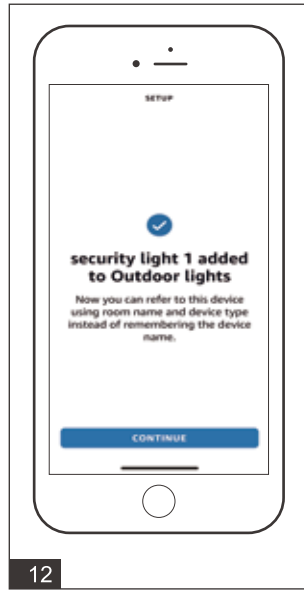

12

13. The Security Light is now displayed in the group.

You can also select "Add New Favorite" to display your light on the Device main page.



13

14. The Security Light can control basic On/Off, Brightness, and Color adjustments.

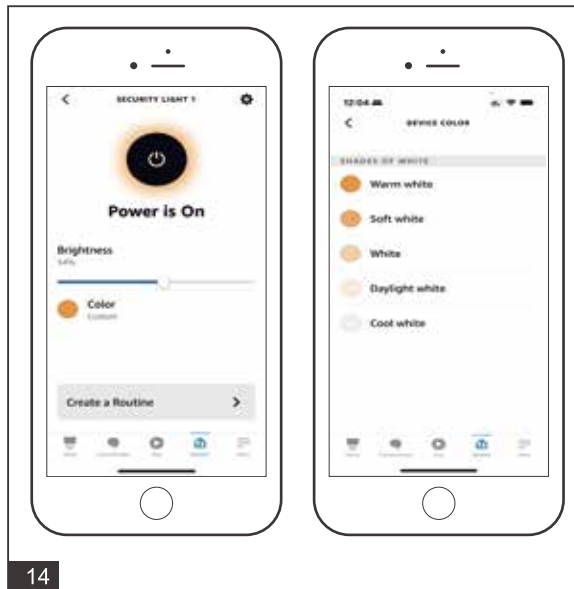

14

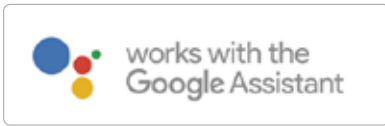

Google voice commands that work with Google Home to control your security light.

Adjust brightness:

- Hi, Google, turn on/off security light;
- Hi, Google, make security light to 10% ~ 100% percent;
- Hi, Google, brighten/increase security light;
- Hi, Google, dim/decrease security light.

Adjust color temperature:

- Hi, Google, make security light to warm white;
- Hi, Google, make security light to soft white;
- Hi, Google, make security light to white;
- Hi, Google, make security light to daylight white.

Connecting to Google Home

1. Search "Google Home" in Google Play or App Store to download Google Home App and complete sign in.



2. Find and select add(+) icon, then select setup device.



3. Select Works with Google.



4. Search and select Innovation & Perfect.



USER GUIDE (continued)

5. Login using the same username and password that you have registered in the "Dualux" or "DualuxBT" App



6. Under "Choose device" select security light."



7. Select or create your home.

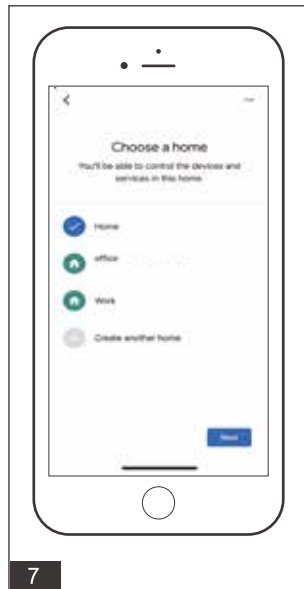

8. Select or create a location for the light.



9. Select or create your home.

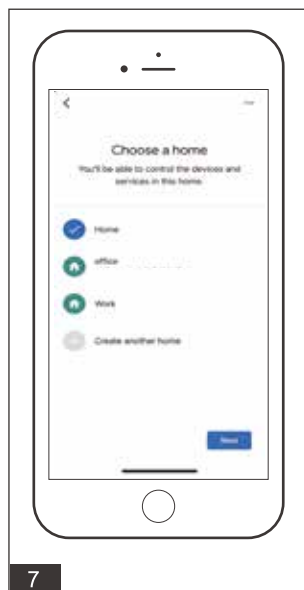

10. After setup is complete you will be taken to the home page. Use voice controls or select the "Security Light" to adjust the functions.

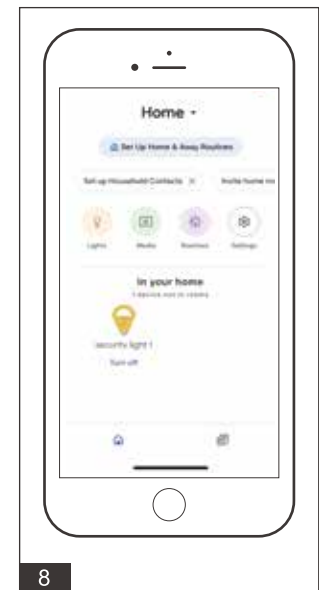

10. Select the "Security Light" icon to control basic On/Off, Brightness, and Color adjustments.



Range	Up to 70ft. (Varies with air temperature)
Sensing angle	Up to 240°
Electrical load - LED	28W
Lumens	2600lm
Power requirements	120 VAC, 60Hz
Operating modes	Test, Auto, Custom, D2D
Time delay	30s - 20min
Mobile device requirements	Running IOS 12.0 x or later. Android 7.0 or later

Troubleshooting

---The light does not come on at all:

1. Make sure the wall switch and circuit breaker are on.
2. Make sure the wiring is correct.
3. Cover the sensor with dark color cloth to verify that the ambient light level is not too high.

---The light comes on for no apparent reason

1. Re-aim the motion sensor.
2. Decrease the sensitivity setting.
3. Do not use a dimmer or timer to control the light fixture. Replace the dimmer or timer with a standard on/off switch

---The light flashes on and off:

1. Reposition the bulb away from the motion sensor.
2. Reposition the motion sensor.
3. The motion sensor is in "TEST" mode and warm up.

The following parts are available for re-order if damaged or missing. Call our toll free at 1-800-887-6326.

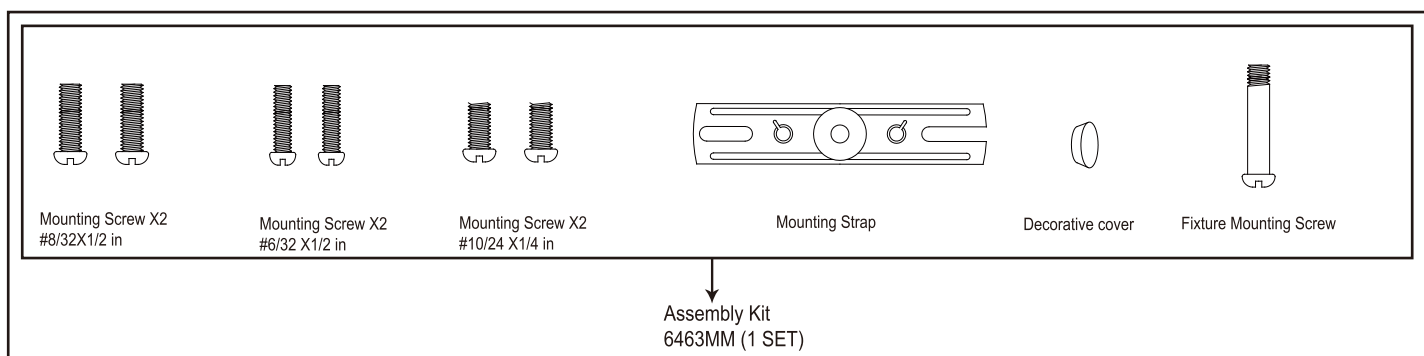

5-YEAR LIMITED WARRANTY:

All products are warranted to be free of defects in material and workmanship for five (5) years from date of purchase. This warranty is limited to the correction of any such defect, or the replacement of any such defective item(s), provided that: (a) we are properly notified and consent to return of the item(s) in question; (b) the item(s) is / are returned with proof of purchase date; and (c) it is found upon inspection by us that the item(s) is / are defective as noted above. This warranty does not cover labor costs, consequential damages, nor does it apply to any item(s) that have been improperly installed, overloaded, altered, or otherwise abused by the customer, its agent(s) or employee(s). Finishes are specially excluded from the terms of this warranty since they are subject to environmental maintenance deemed beyond our control. Other than the described obligation, we assume no further liability with respect to the sale or use of our products. We make no warranty, express or implied, and disclaim any warranty of merchantability or fitness for a particular purpose.

FCC Statement

This device complies with Part 15 of the FCC Rules. Operation is subject to the following two conditions:

(1) this device may not cause harmful interference, and (2) this device must accept any interference received, including interference that may cause undesired operation.

Changes or modifications to this unit not expressly approved by the party responsible for compliance could void the user's authority to operate the equipment.

NOTE: This equipment has been tested and found to comply with the limits for a Class B digital device, pursuant to Part 15 of the FCC Rules. These limits are designed to provide reasonable protection against harmful interference in a residential installation. This equipment generates uses and can radiate radio frequency energy and, if not installed and used in accordance with the instructions, may cause harmful interference to radio communications.

However, there is no guarantee that interference will not occur in a particular installation. If this equipment does cause harmful interference to radio or television reception, which can be determined by turning the equipment off and on, the user is encouraged to try to correct the interference by one or more of the following measures:

- Reorient or relocate the receiving antenna.
- Increase the separation between the equipment and receiver.
- Connect the equipment into an outlet on a circuit different from that to which the receiver is connected.
- Consult the dealer or an experienced radio/TV technician for help.

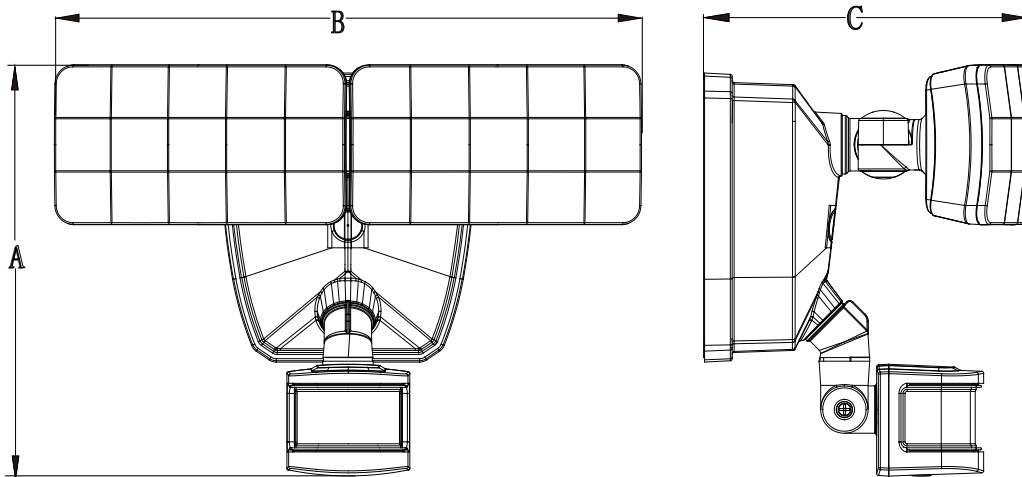

A: 8"

B: 11-1/2"

C: 6-1/2"